



US00D698665S

(12) **United States Design Patent**
Sifuentes et al.

(10) **Patent No.:** **US D698,665 S**
(45) **Date of Patent:** **** Feb. 4, 2014**

- (54) **TRAY**
- (71) Applicants: **Direct Pack, Inc.**, Sun Valley, CA (US);
Five Star Gourmet Foods, Inc.,
Ontario, CA (US)
- (72) Inventors: **Gandhi B. Sifuentes**, West Covina, CA
(US); **Craig R. Snedden**, Culver City,
CA (US); **Tal Shoshan**, Alta Loma, CA
(US)
- (73) Assignees: **Direct Pack, Inc.**, Sun Valley, CA (US);
Five Star Gourmet Foods, Inc.,
Ontario, CA (US)

4,807,776 A *	2/1989	Cortopassi	220/23.83
D444,058 S *	6/2001	Hampshire et al.	D9/761
D513,979 S *	1/2006	Snedden et al.	D9/425
D514,931 S *	2/2006	Snedden et al.	D9/425
D517,405 S *	3/2006	Snedden et al.	D9/425
D551,091 S *	9/2007	Shahsavarani	D9/761
D597,379 S *	8/2009	Changpan	D7/542
D607,284 S *	1/2010	Ho	D7/629
D628,478 S *	12/2010	Snedden et al.	D9/431
D628,479 S *	12/2010	Snedden et al.	D9/431
D632,170 S *	2/2011	Lawrence et al.	D9/425
D640,129 S *	6/2011	Sifuentes et al.	D9/425
D640,544 S *	6/2011	Sifuentes et al.	D9/425
D642,484 S *	8/2011	Birchmeier et al.	D9/760
D642,937 S *	8/2011	Birchmeier et al.	D9/760
D646,969 S *	10/2011	Snedden et al.	D9/431
D646,984 S *	10/2011	Moore et al.	D9/737
D660,147 S *	5/2012	Snedden et al.	D9/435
D665,663 S *	8/2012	Krupa	D9/428
D688,126 S *	8/2013	Snedden et al.	D9/435
D688,941 S *	9/2013	Sifuentes et al.	D9/432

(**) Term: **14 Years**

(21) Appl. No.: **29/438,978**

(22) Filed: **Dec. 5, 2012**

(51) **LOC (10) Cl.** **09-03**

(52) **U.S. Cl.**
USPC **D9/761**; D9/425; D9/431

(58) **Field of Classification Search**
USPC D9/414, 419, 424, 425, 430, 431, 432,
D9/435, 761; D7/538, 549, 550.1,
D7/601-603, 605, 629; 229/105, 117.09,
229/117.26, 189, 406, 407, 902, 905,
229/915.1; 220/23.4, 23.6, 266, 281, 315,
220/318, 500, 659, 669, 674, 675, 696, 752,
220/760, 790, 793, DIG. 12, FOR. 117;
206/508, 557, 499
See application file for complete search history.

(56) **References Cited**

U.S. PATENT DOCUMENTS

3,070,275 A *	12/1962	Bostrom	229/4.5
D292,887 S *	11/1987	Schouten	D9/424

* cited by examiner

Primary Examiner — Mark Goodwin

(74) *Attorney, Agent, or Firm* — Frost Brown Todd LLC

(57) **CLAIM**

The ornamental design for a tray, as shown and described.

DESCRIPTION

FIG. 1 is a top perspective view of a tray, showing our new design;
FIG. 2 is a bottom perspective view thereof;
FIG. 3 is a front elevation view thereof;
FIG. 4 is a rear elevation view thereof;
FIG. 5 is a left elevation view thereof;
FIG. 6 is a right elevation view thereof;
FIG. 7 is a top plan view thereof; and,
FIG. 8 is a bottom plan view thereof.

1 Claim, 8 Drawing Sheets

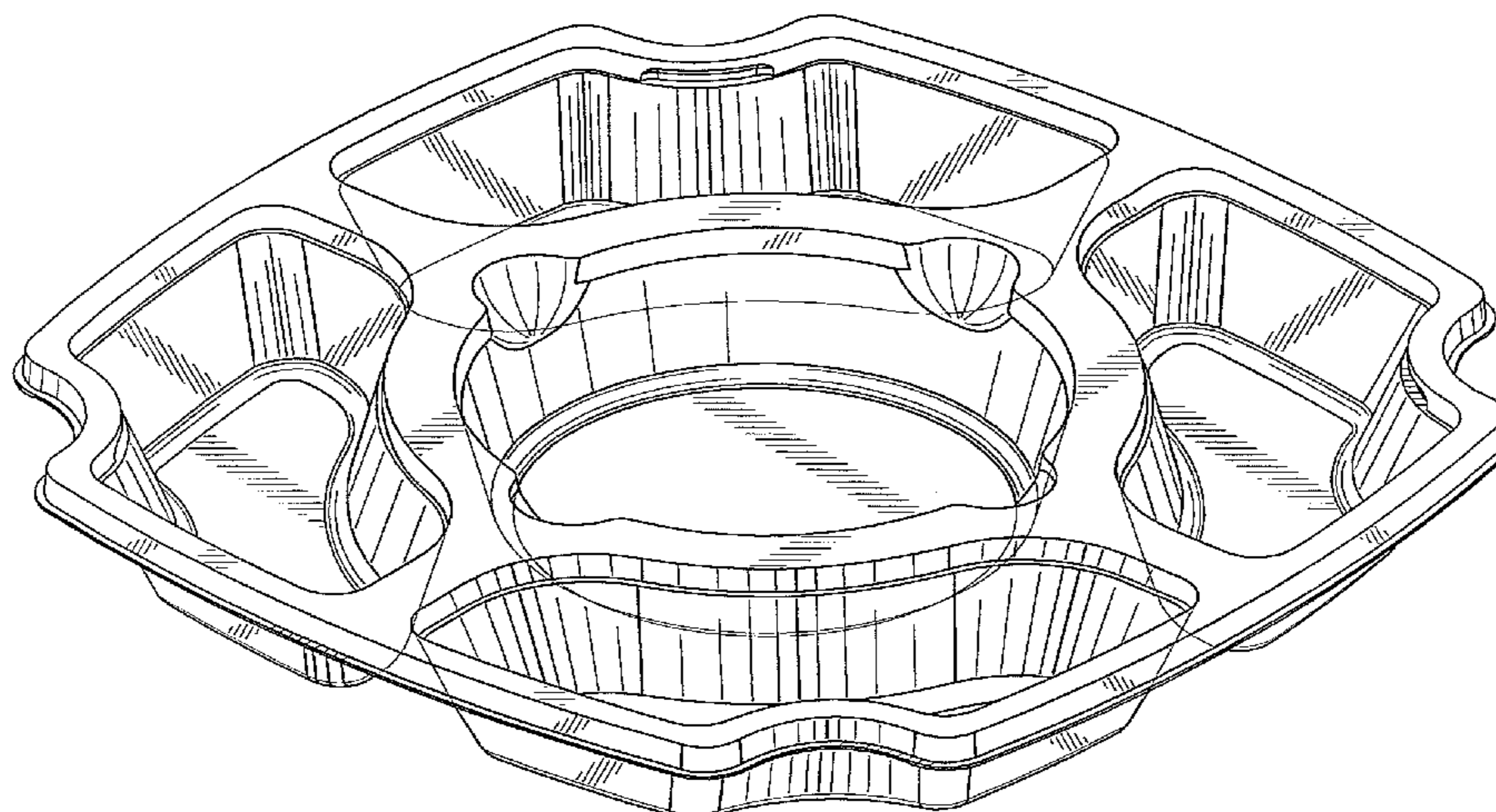

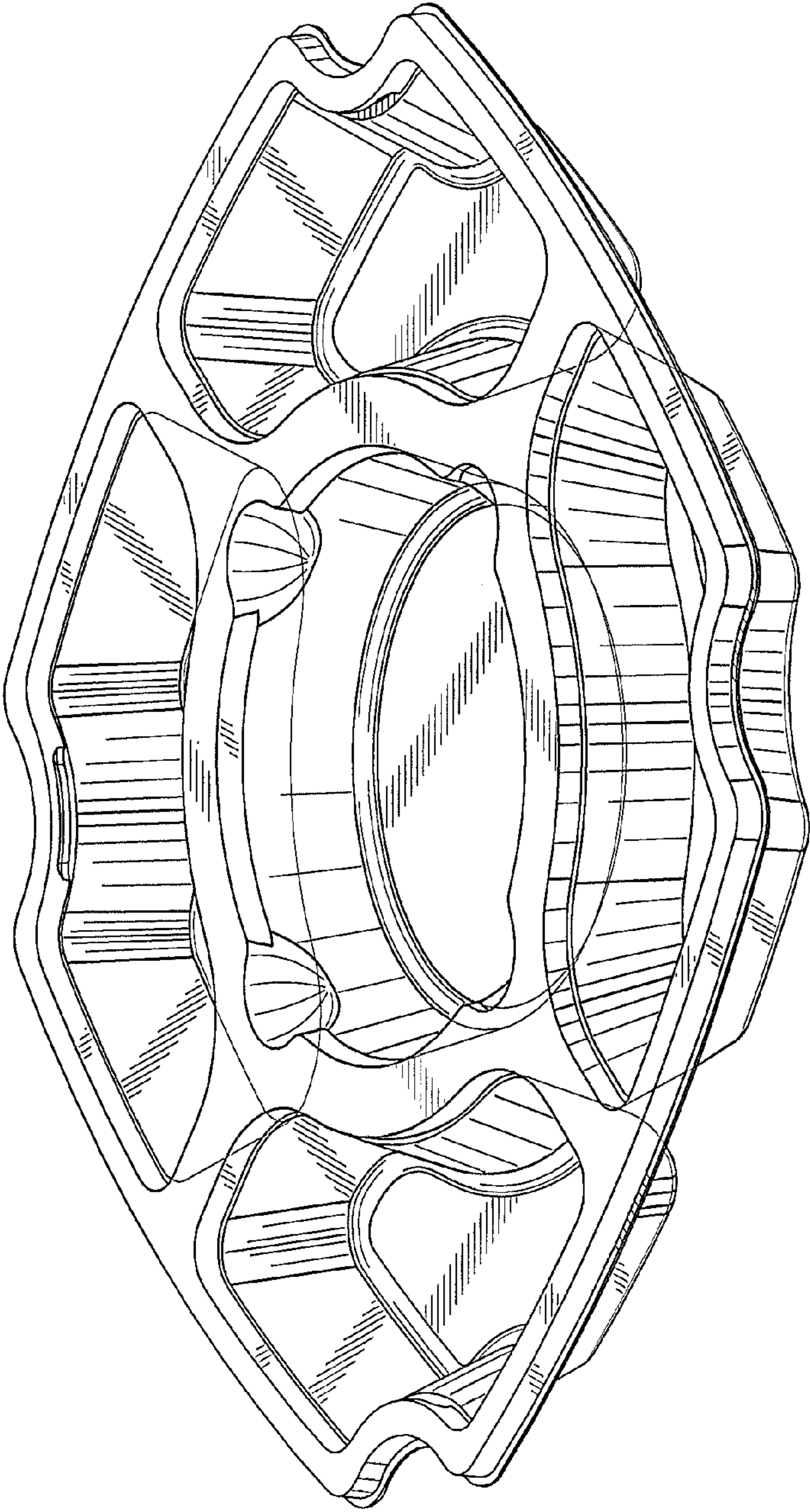

Fig.1

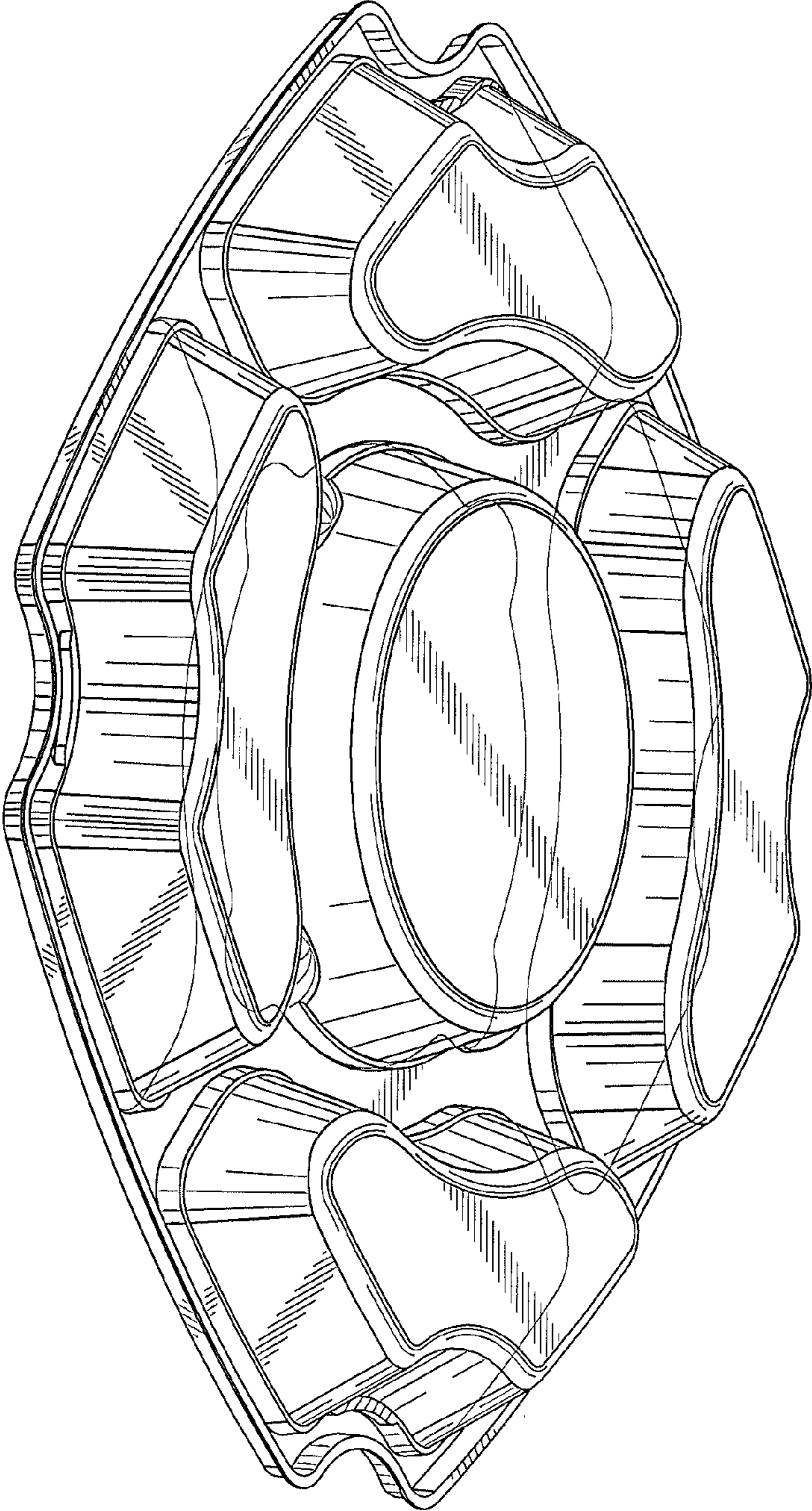

Fig. 2

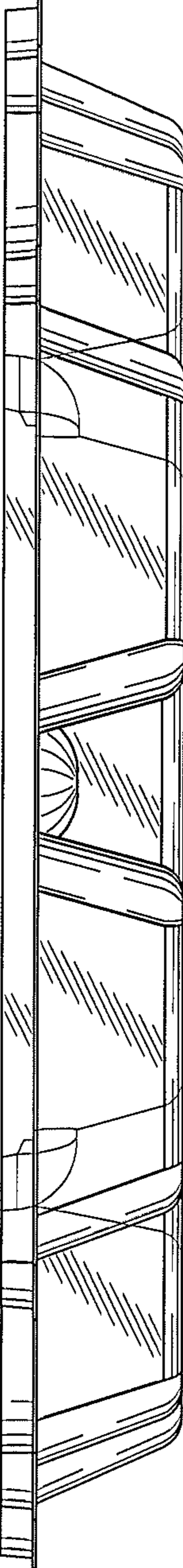

Fig. 3

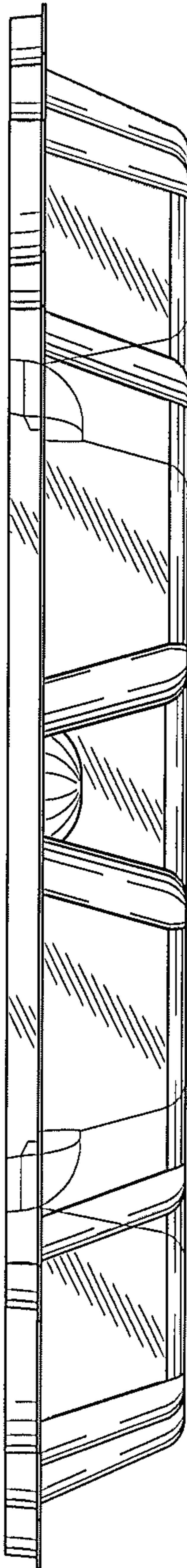

Fig. 4

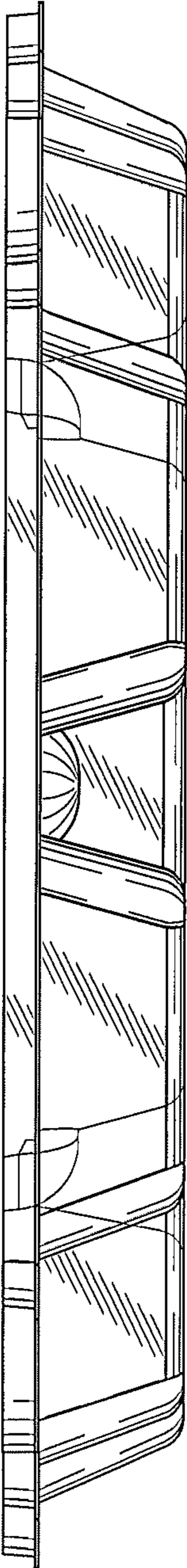

Fig. 5

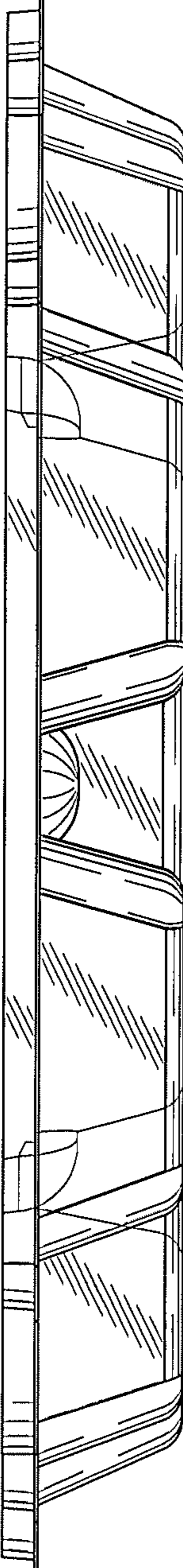

Fig. 6

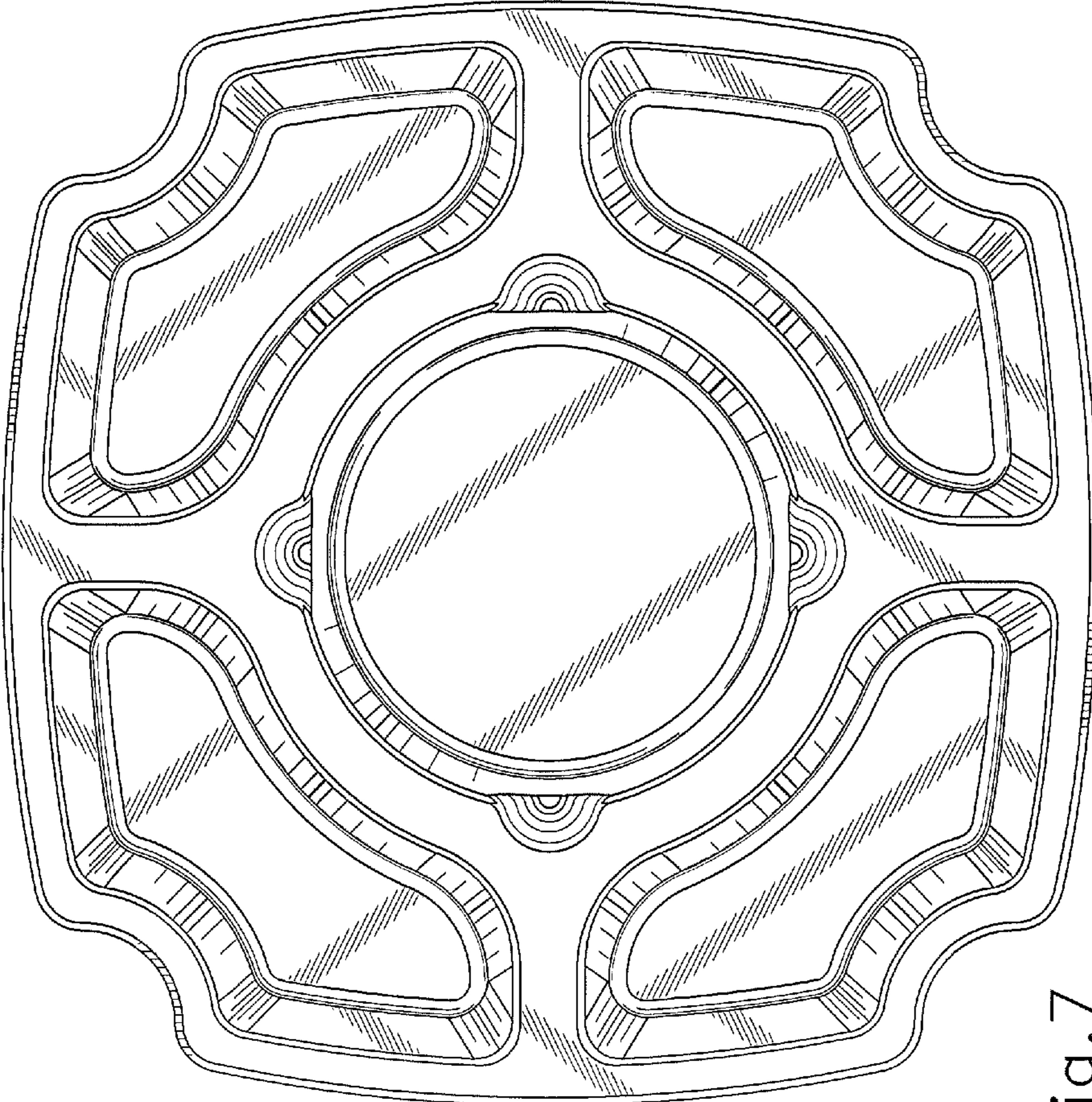

Fig. 7

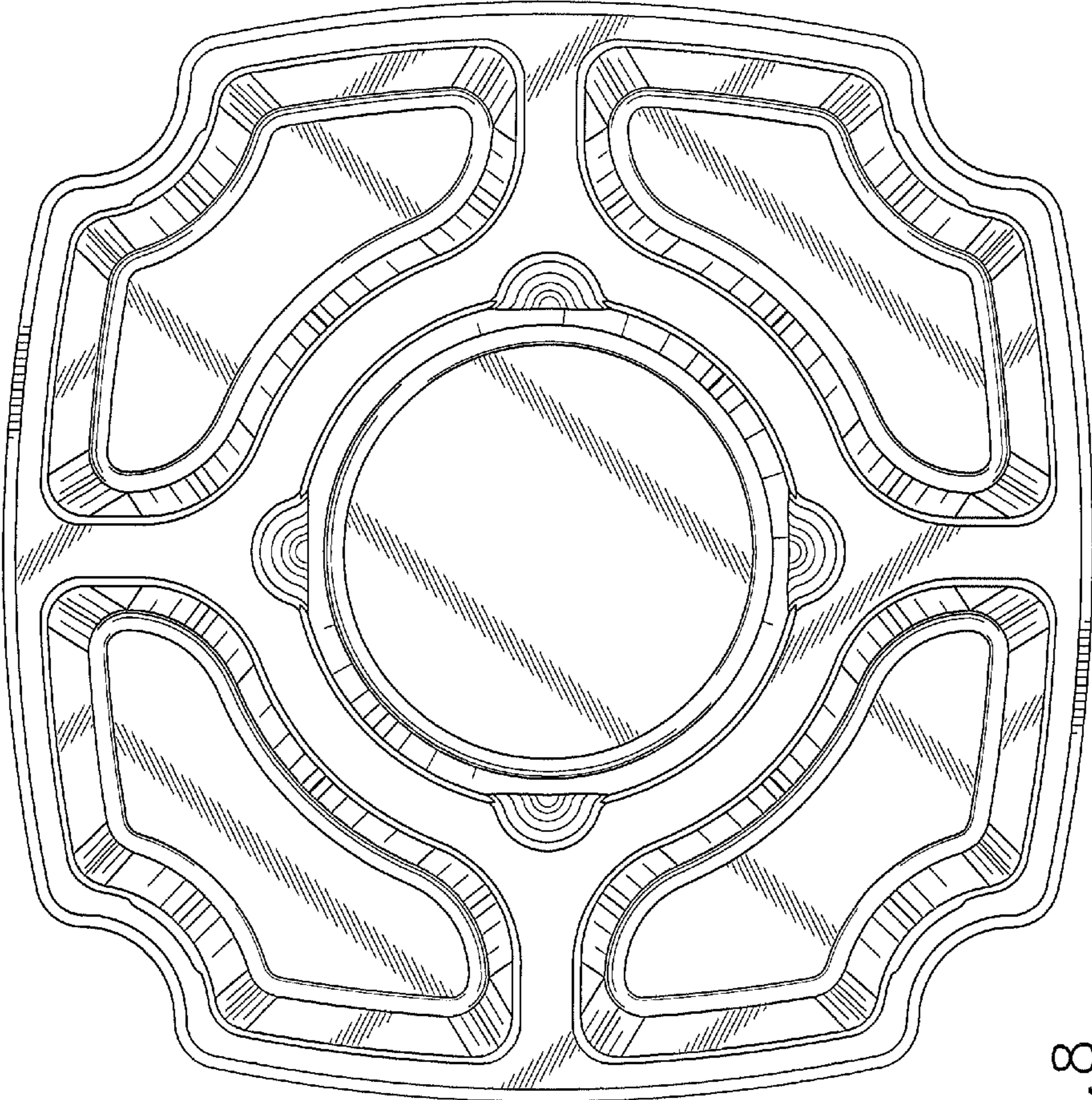

Fig. 8