



US00D698642S

(12) **United States Design Patent**
Tawada

(10) **Patent No.:** **US D698,642 S**
(45) **Date of Patent:** **** Feb. 4, 2014**

(54) **BOX FOR A PACKAGE**
(71) Applicant: **Japan Tobacco Inc.**, Tokyo (JP)
(72) Inventor: **Shunsuke Tawada**, Tokyo (JP)
(73) Assignee: **Japan Tobacco Inc.**, Tokyo (JP)
(**) Term: **14 Years**

(21) Appl. No.: **29/459,329**
(22) Filed: **Jun. 28, 2013**

(30) **Foreign Application Priority Data**
Dec. 28, 2012 (JP) 2012-032157
(51) **LOC (10) Cl.** **09-03**
(52) **U.S. Cl.**
USPC **D9/423; D9/433**
(58) **Field of Classification Search**
USPC D9/414, 416, 420, 421, 423, 426, 430,
D9/432; 206/236–241, 249–251, 254–259,
206/261–275; 229/160.1; D27/185–192
See application file for complete search history.

(56) **References Cited**
U.S. PATENT DOCUMENTS
4,923,059 A * 5/1990 Evers et al. 206/265
D322,687 S * 12/1991 Tschudin D27/189
D441,496 S * 5/2001 Focke et al. D27/189

6,457,580 B1 * 10/2002 Focke et al. 206/259
6,527,166 B1 * 3/2003 Focke et al. 229/146
6,591,982 B2 * 7/2003 Focke et al. 206/259
6,755,300 B2 * 6/2004 Brizzi 206/273
7,438,183 B2 * 10/2008 Focke et al. 206/268
D592,496 S * 5/2009 Tabrah D9/423
8,485,355 B2 * 7/2013 England 206/259
2002/0179464 A1 * 12/2002 Focke et al. 206/259
2006/0191986 A1 * 8/2006 Focke et al. 229/146

* cited by examiner

Primary Examiner — Thomas Johannes

(74) *Attorney, Agent, or Firm* — Ohlandt, Greeley, Ruggiero & Perle, LLP

(57) **CLAIM**
The ornamental design for a box for a package, as shown and described.

DESCRIPTION
FIG. 1 is a perspective view of a box for a package, showing my new design;
FIG. 2 is a front elevational view thereof;
FIG. 3 is a rear elevational view thereof;
FIG. 4 is a top plan view thereof;
FIG. 5 is a bottom plan view thereof;
FIG. 6 is a right side elevational view thereof; the opposite side being a mirror image thereof;
FIG. 7 is a Perspective view with the lid in a closed state thereof; and,
FIG. 8 is a plan view for the inner sleeve portion thereof.

1 Claim, 7 Drawing Sheets

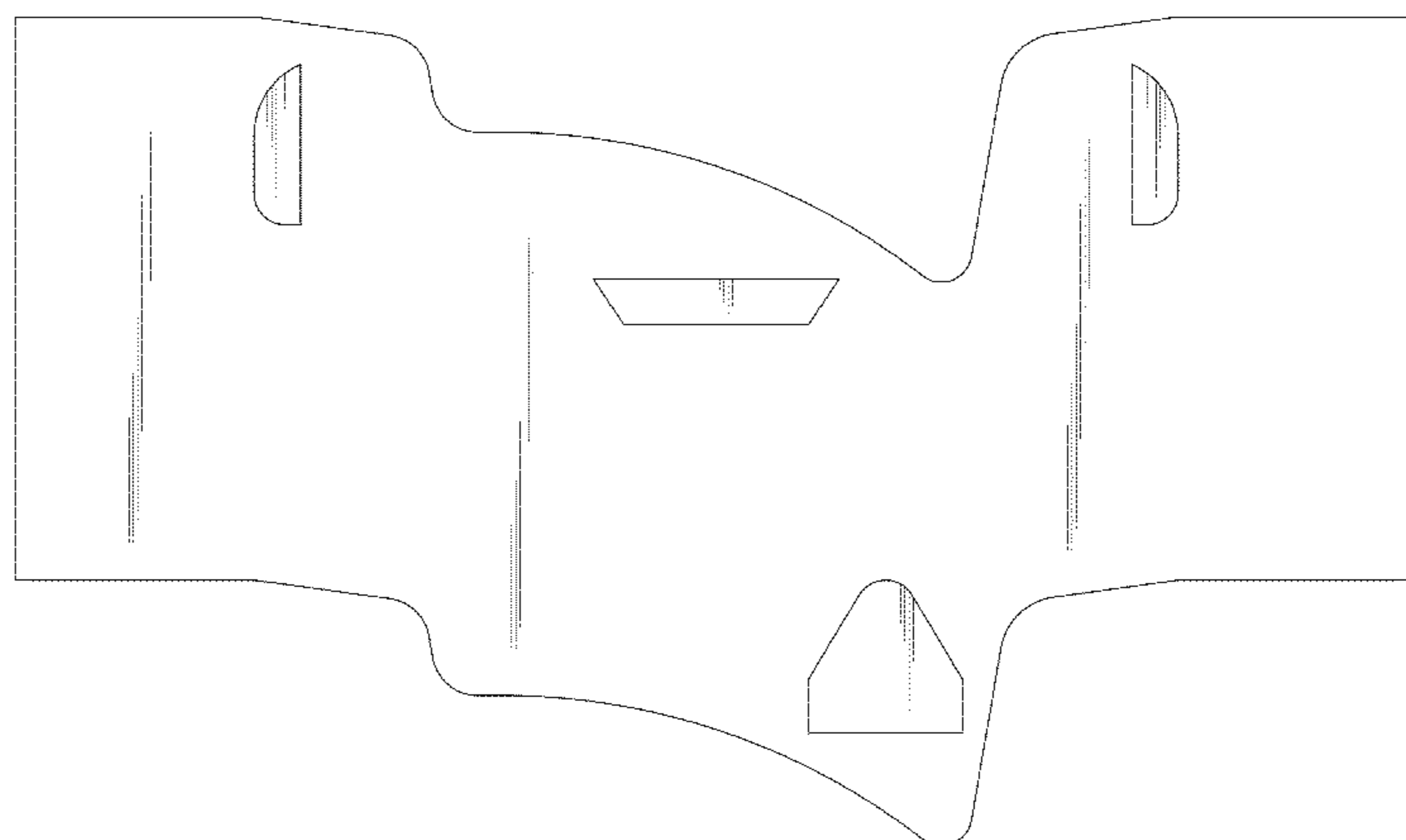
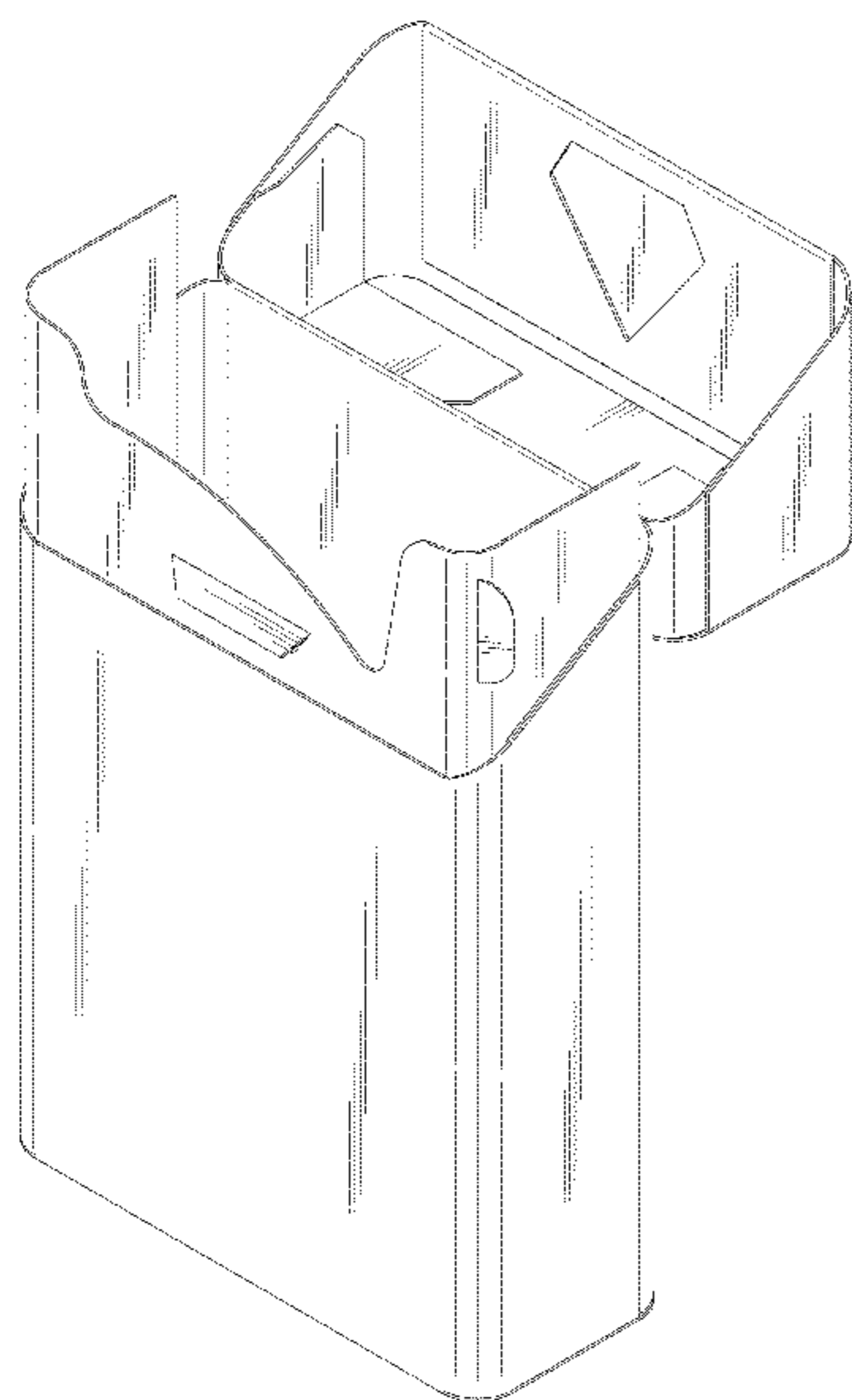

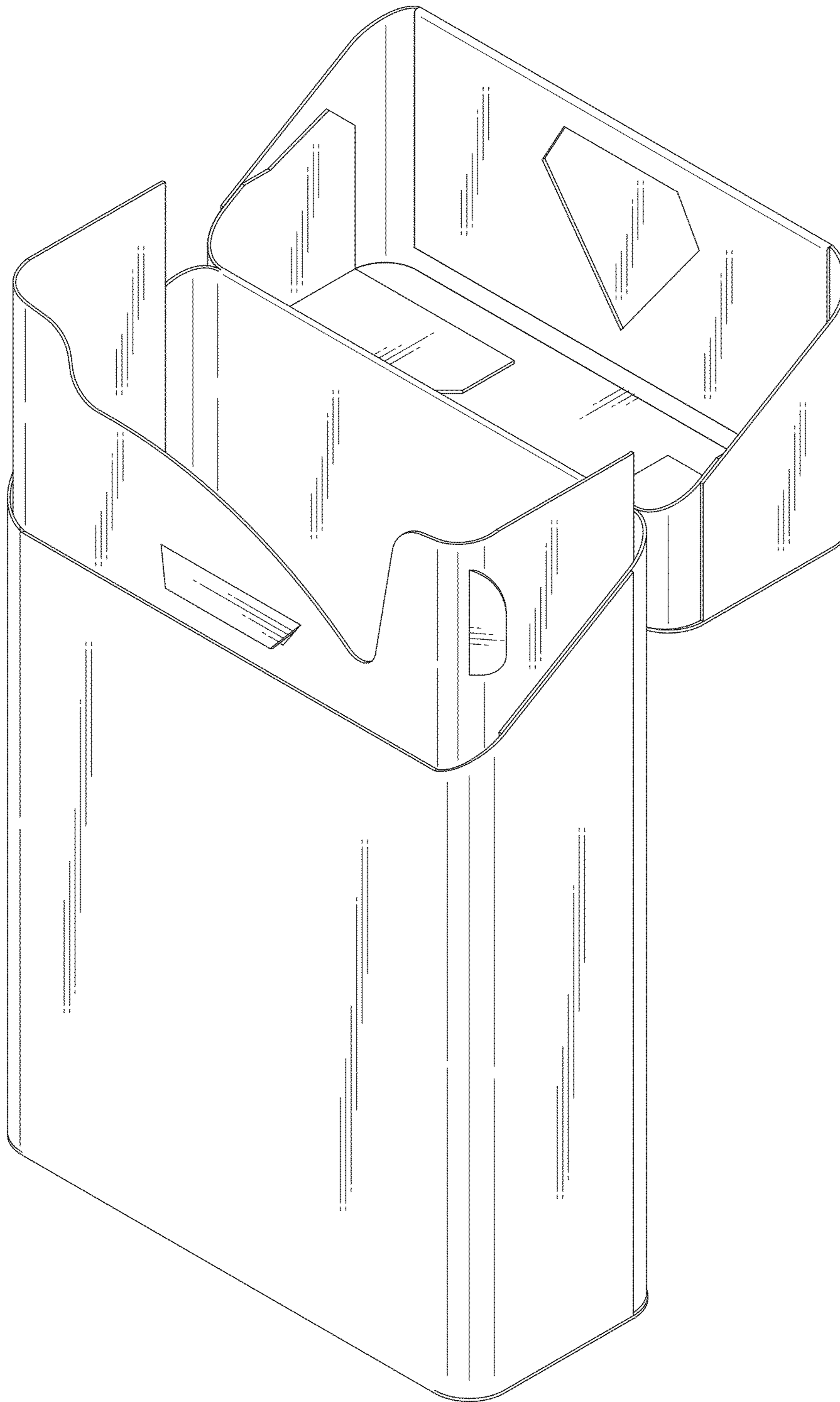

Fig. 1

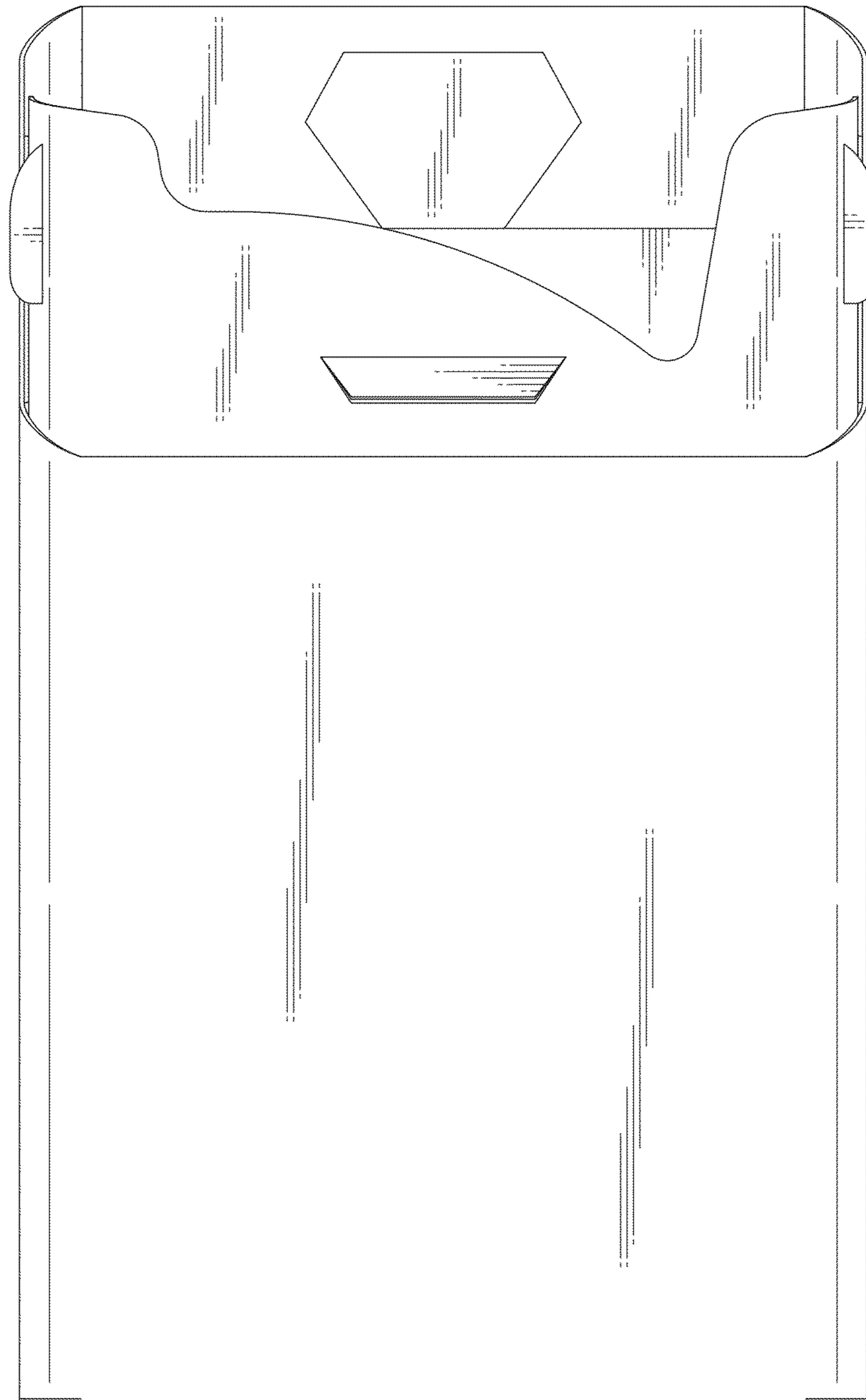

Fig. 2

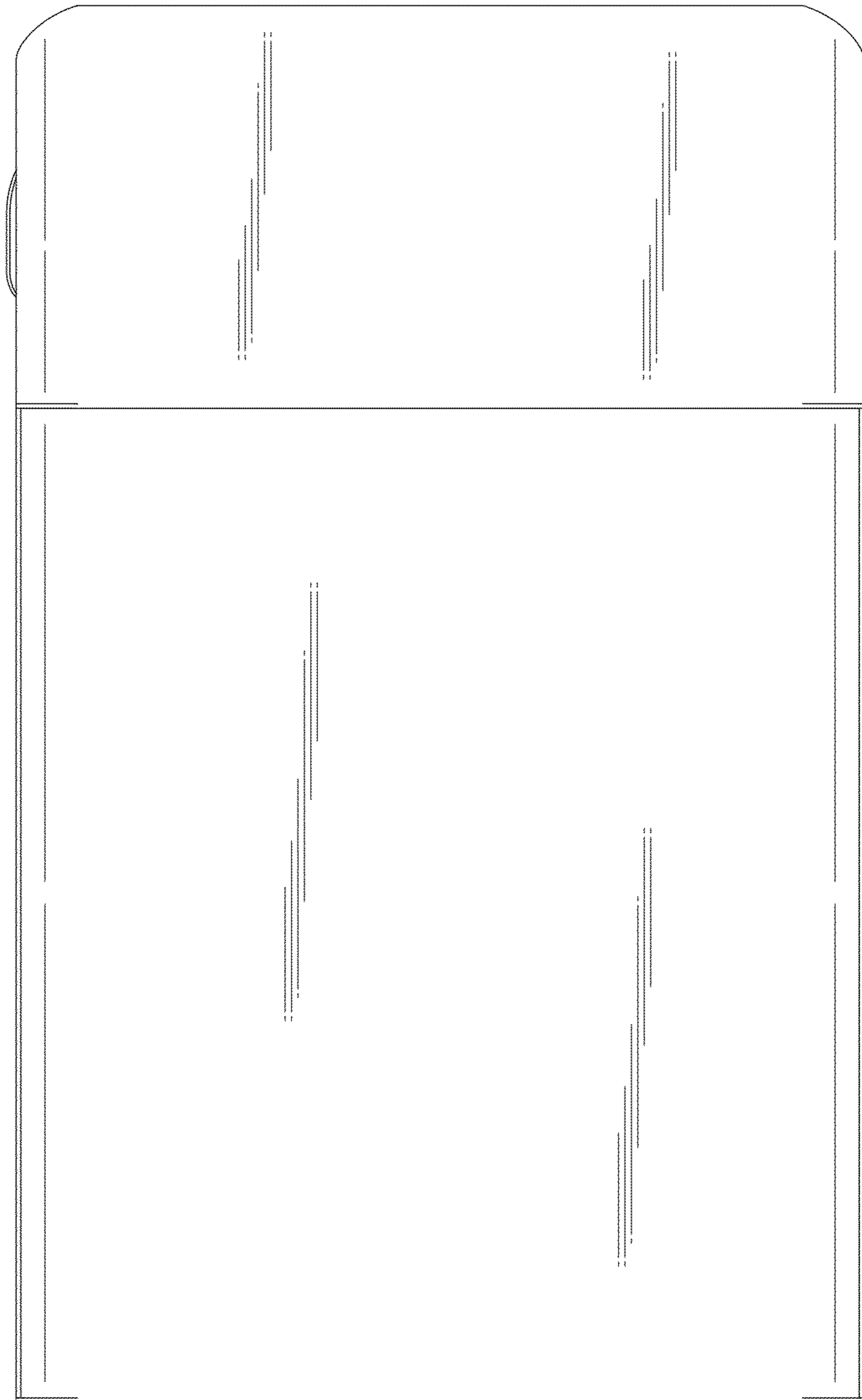

Fig. 3

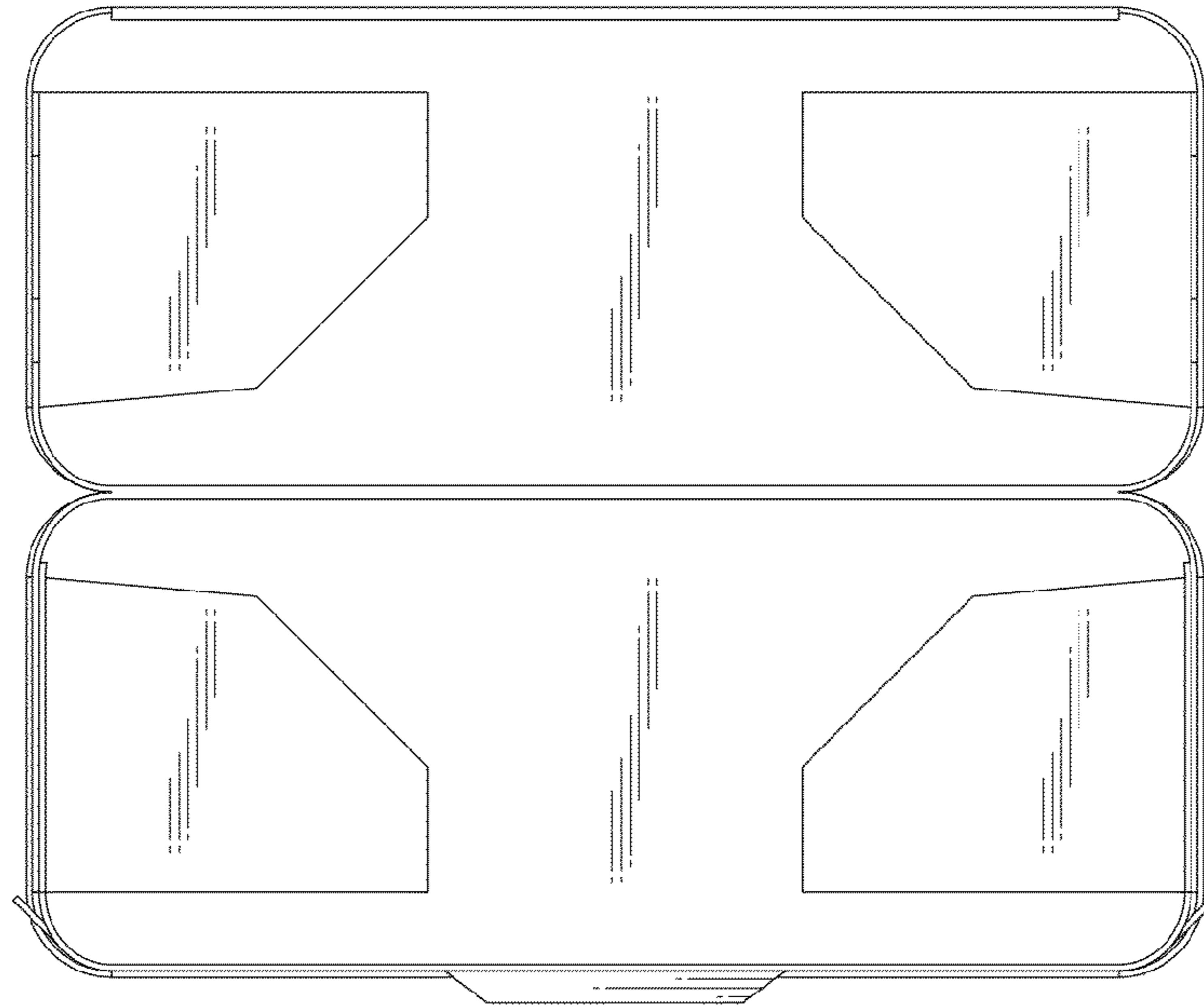

Fig. 4

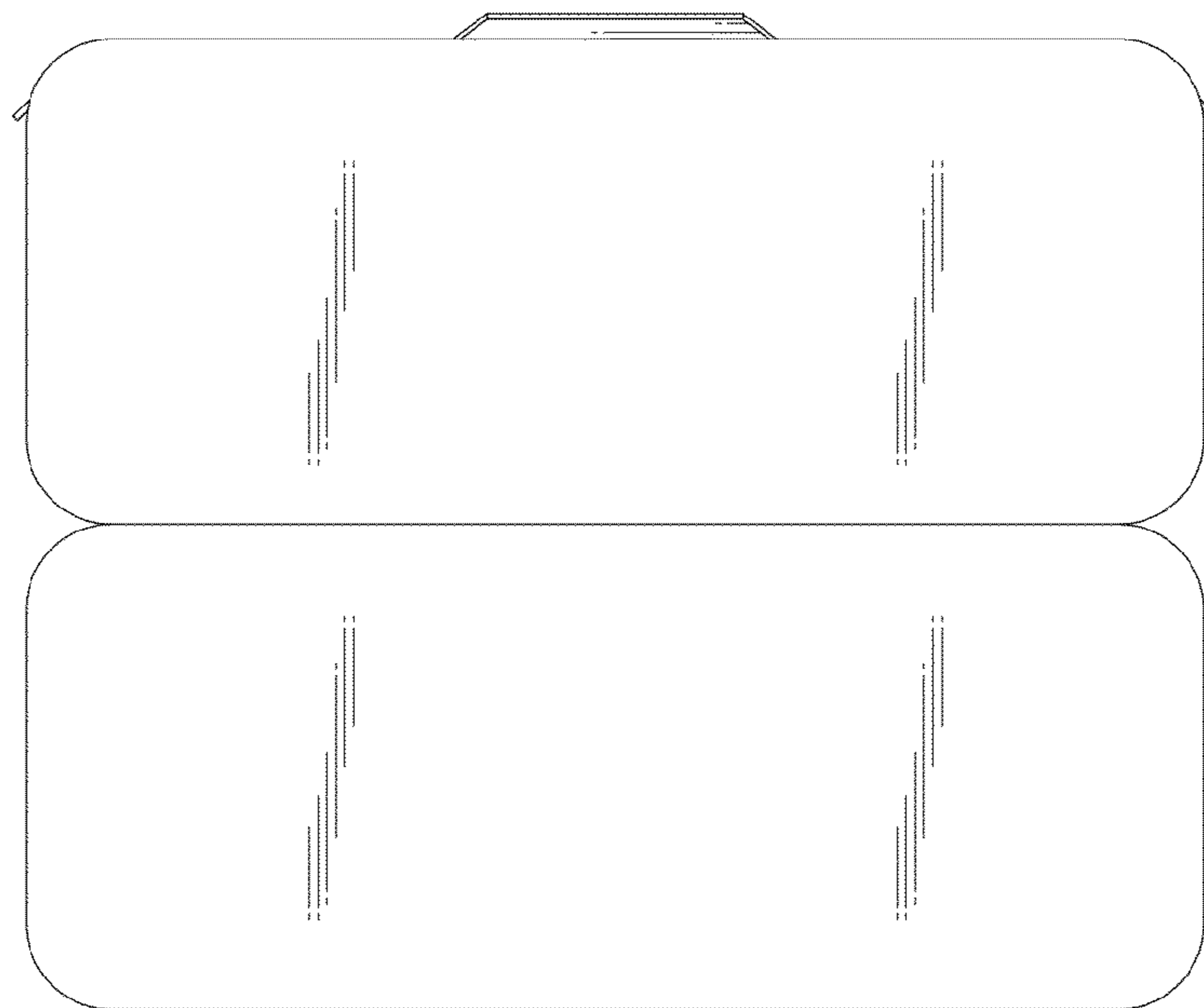

Fig. 5

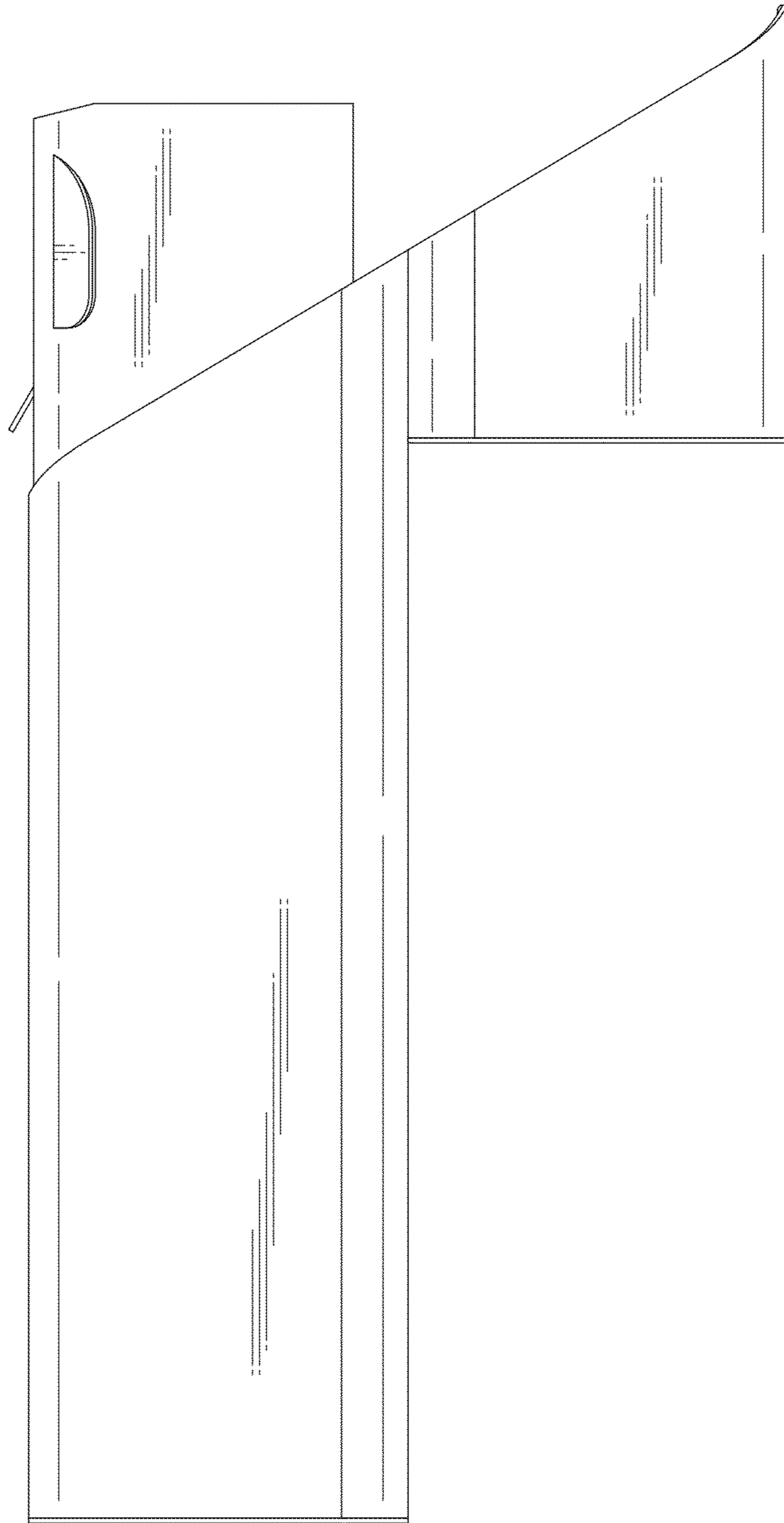

Fig. 6

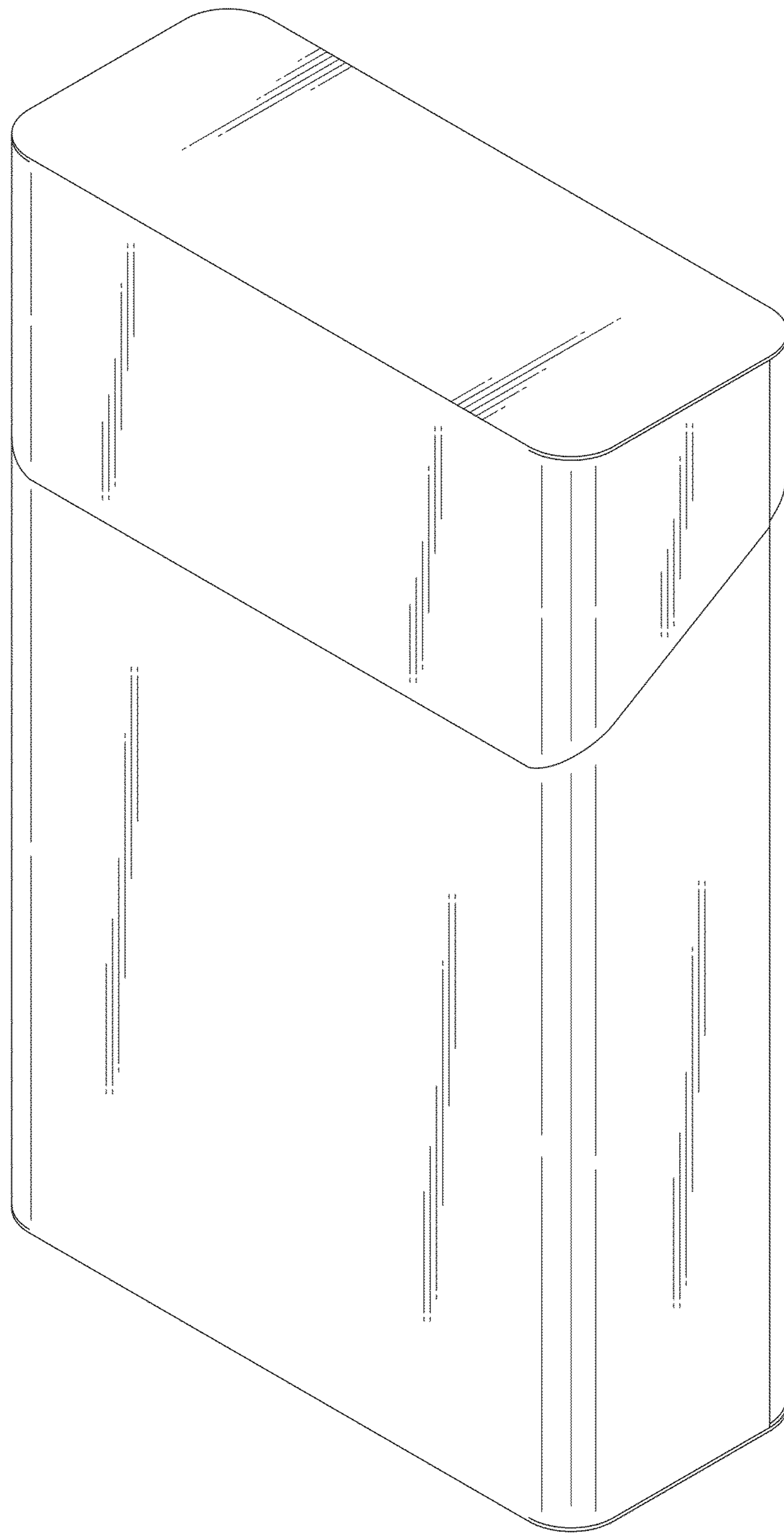

Fig. 7

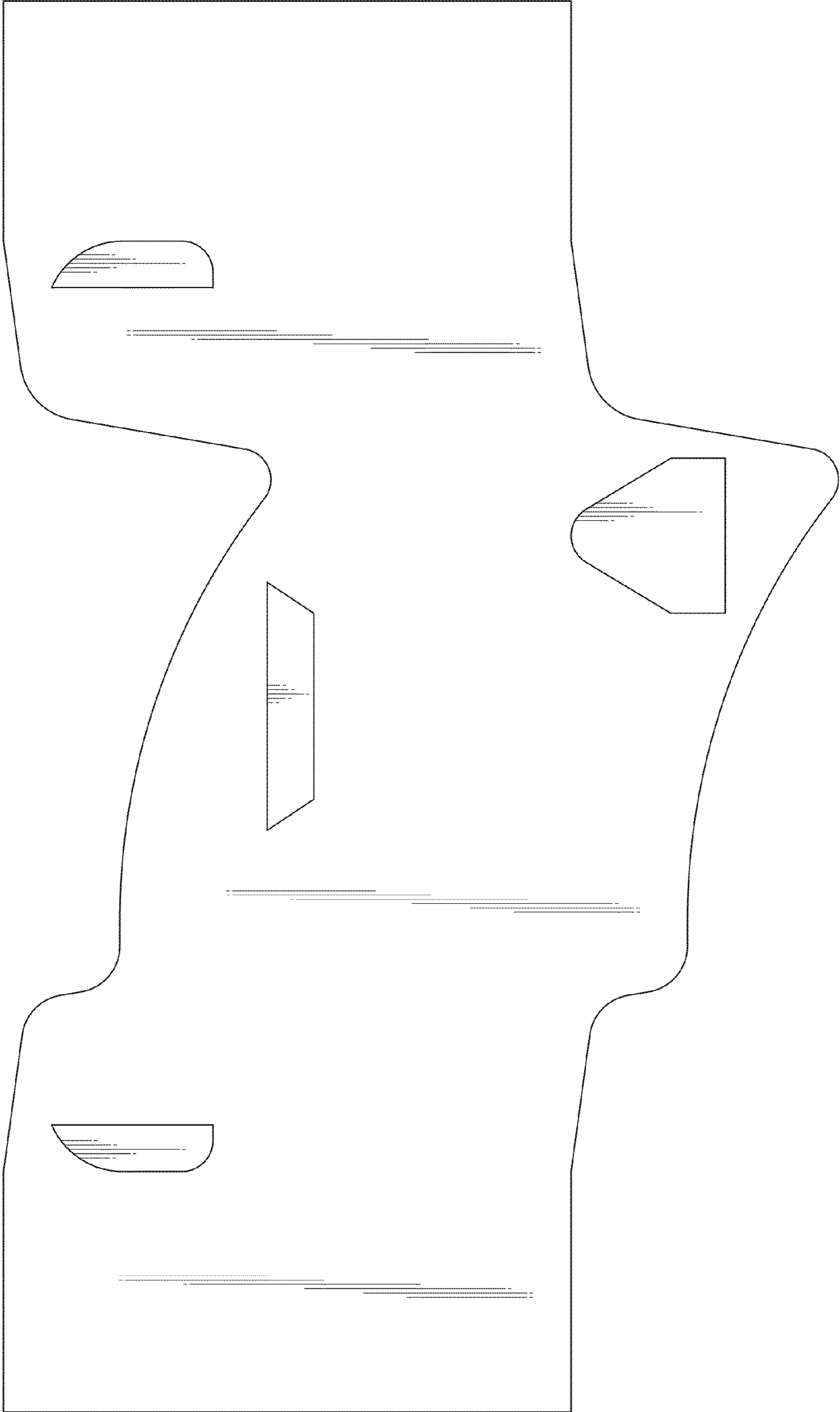

Fig. 8