



US00D698550S

(12) **United States Design Patent**
Louboutin

(10) **Patent No.:** **US D698,550 S**
(45) **Date of Patent:** **** Feb. 4, 2014**

(54) **CLASP**

DESCRIPTION

(71) Applicant: **Christian Louboutin**, Paris (FR)

(72) Inventor: **Christian Louboutin**, Paris (FR)

(**) Term: **14 Years**

(21) Appl. No.: **29/437,511**

(22) Filed: **Nov. 16, 2012**

(30) **Foreign Application Priority Data**

Oct. 15, 2012 (EP) 002118380

(51) **LOC (10) Cl.** **03-01**

(52) **U.S. Cl.**
USPC **D3/318**

(58) **Field of Classification Search**
USPC D3/232-233, 240-243, 245-246, 318;
150/100, 103-110, 113-114, 117-119
See application file for complete search history.

(56) **References Cited**

U.S. PATENT DOCUMENTS

512,565 A * 1/1894 Read 150/114
2,026,663 A * 1/1936 Wunthal 150/113

(Continued)

Primary Examiner — Holly Baynham

(74) *Attorney, Agent, or Firm* — Fross Zelnick Lehrman & Zissu, P.C.; Charles T. J. Weigell, Esq.

(57) **CLAIM**

The ornamental design for a clasp, as shown and described.

FIG. 1 is a perspective view of a clasp showing my new design, shown in the environment of a bag;
FIG. 2 is a front view of the clasp shown in FIG. 1;
FIG. 3 is a rear view of the clasp shown in FIG. 1;
FIG. 4 is a right side view of the clasp shown in FIG. 1;
FIG. 5 is a left side view of the clasp shown in FIG. 1;
FIG. 6 is a top view of the card case shown in FIG. 1;
FIG. 7 is a front perspective view of the clasp shown in FIG. 1;
FIG. 8 is a perspective view of a second embodiment of the clasp shown in FIG. 1, shown in the environment of a clutch;
FIG. 9 is a front view of the clasp shown in FIG. 8;
FIG. 10 is a rear view of the clasp shown in FIG. 8;
FIG. 11 is a right side view of the clasp shown in FIG. 8;
FIG. 12 is a left side view of the clasp shown in FIG. 8;
FIG. 13 is a top view of the clasp shown in FIG. 8;
FIG. 14 is a front perspective view of the clasp shown in FIG. 8;
FIG. 15 is a perspective view of a third embodiment of the clasp shown in FIG. 1, shown in the environment of a different clutch;
FIG. 16 is a front view of the clasp shown in FIG. 15;
FIG. 17 is a rear view of the clasp shown in FIG. 15;
FIG. 18 is a right side view of the clasp shown in FIG. 15;
FIG. 19 is a left side view of the clasp shown in FIG. 15;
FIG. 20 is a top view of the clasp shown in FIG. 15; and,
FIG. 21 is a front perspective view of the clasp shown in FIG. 15.

The broken lines showing portions of bags are included for the purpose of illustrating environment and forms no part of the claimed design.

1 Claim, 13 Drawing Sheets

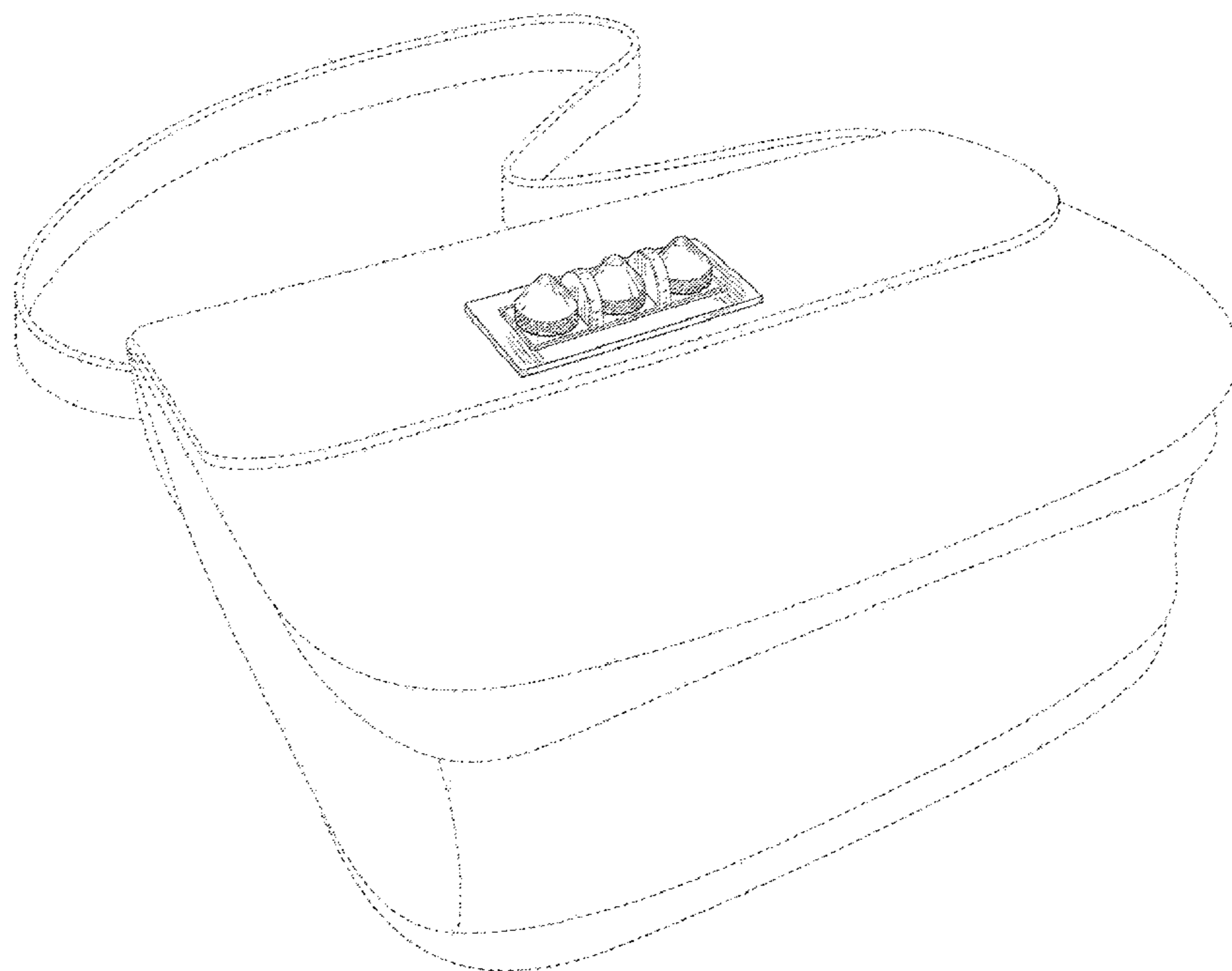

US D698,550 S

Page 2

(56)

References Cited

U.S. PATENT DOCUMENTS

D132,023 S * 4/1942 Adams D3/233
D133,968 S * 9/1942 Tashman D3/243
D570,106 S * 6/2008 Della Valle D3/243
D572,485 S * 7/2008 Gonzalez D3/318

D595,506 S * 7/2009 Hacker D3/318
D599,554 S * 9/2009 Gonzalez D3/318
D609,004 S * 2/2010 Dolce et al. D3/240
D635,357 S * 4/2011 Guyon et al. D3/243
D661,894 S * 6/2012 Sassi D3/245

* cited by examiner

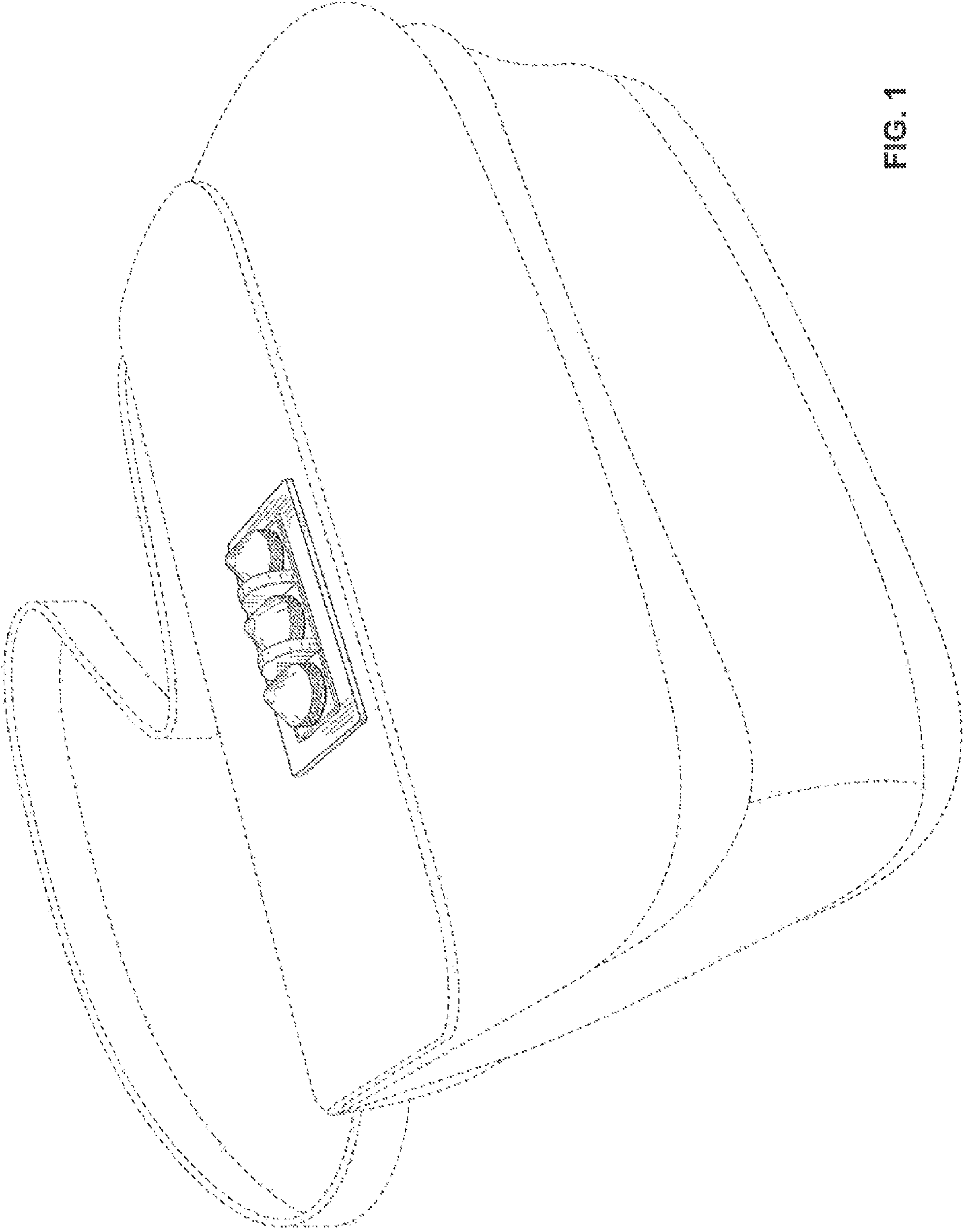

FIG. 1

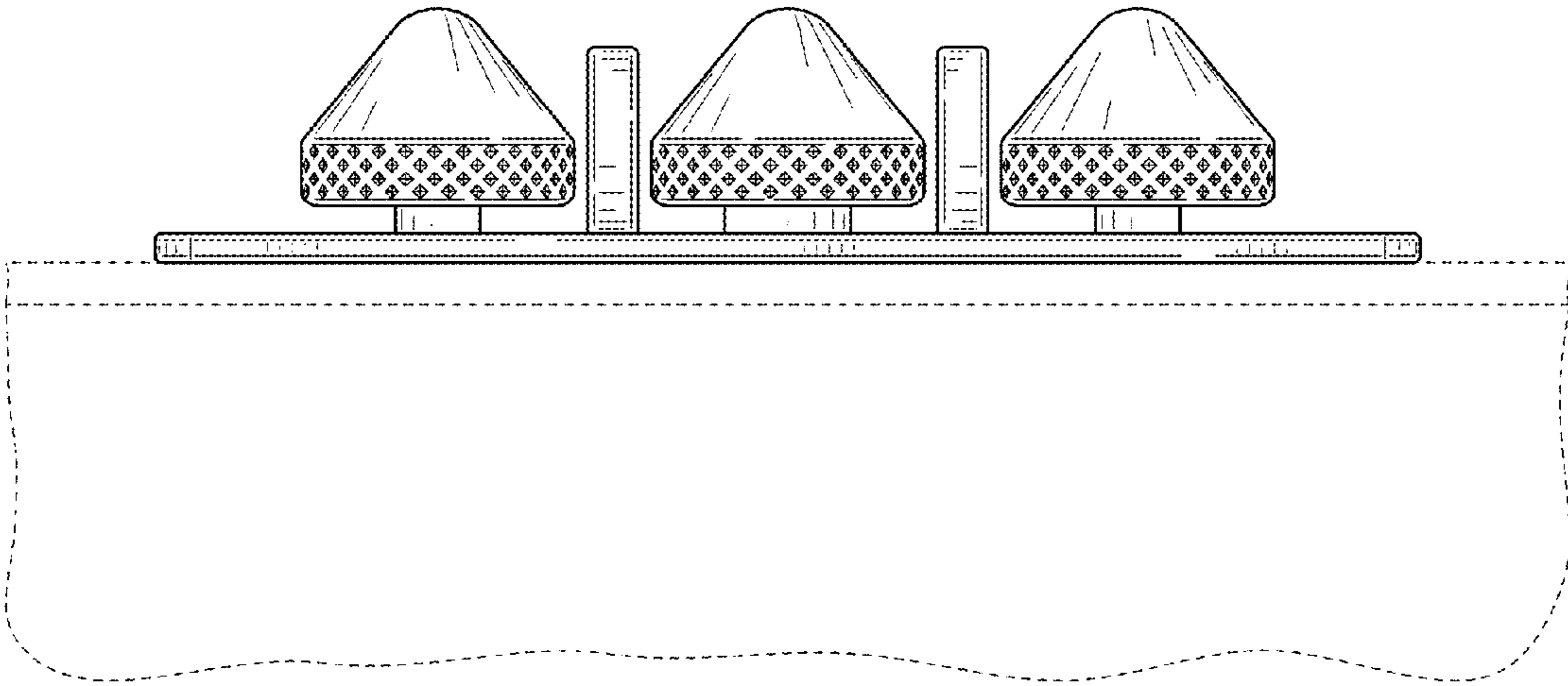

FIG. 2

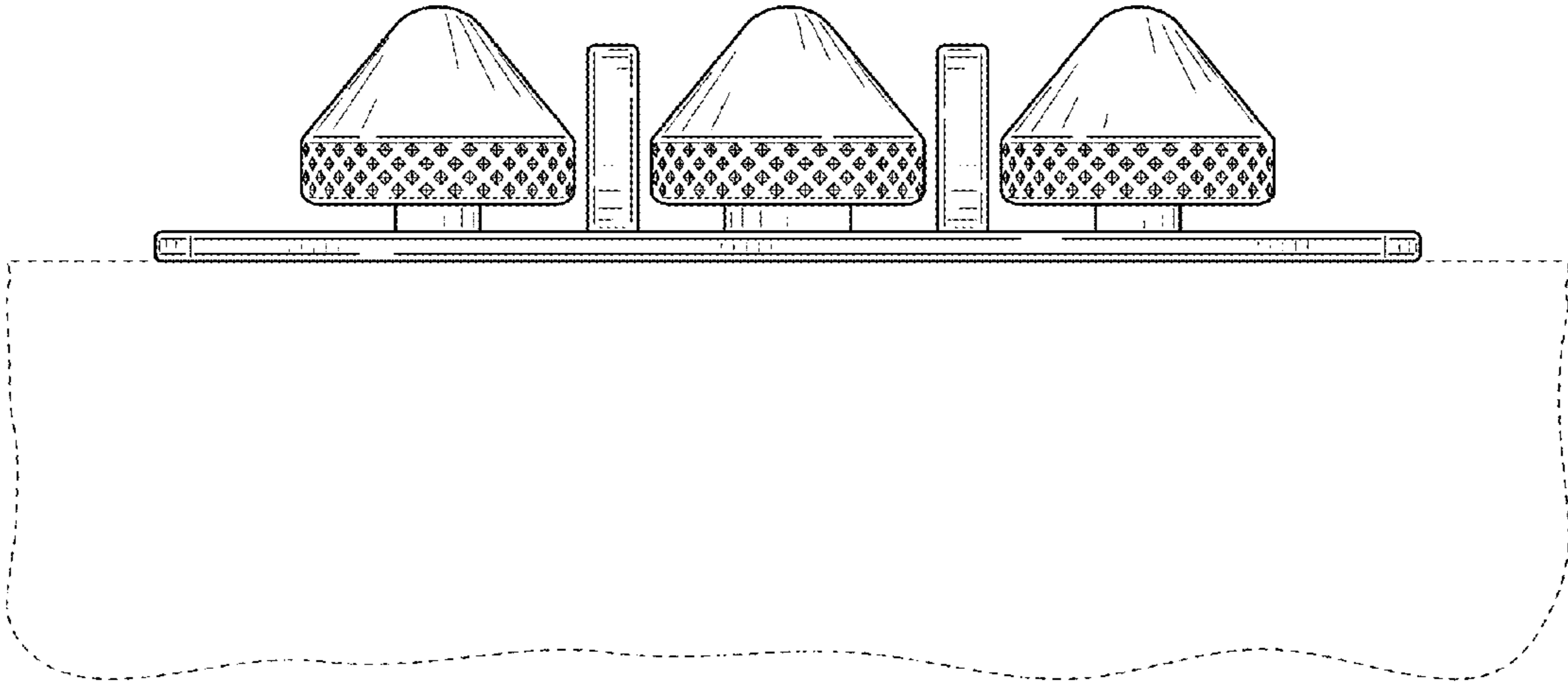

FIG. 3

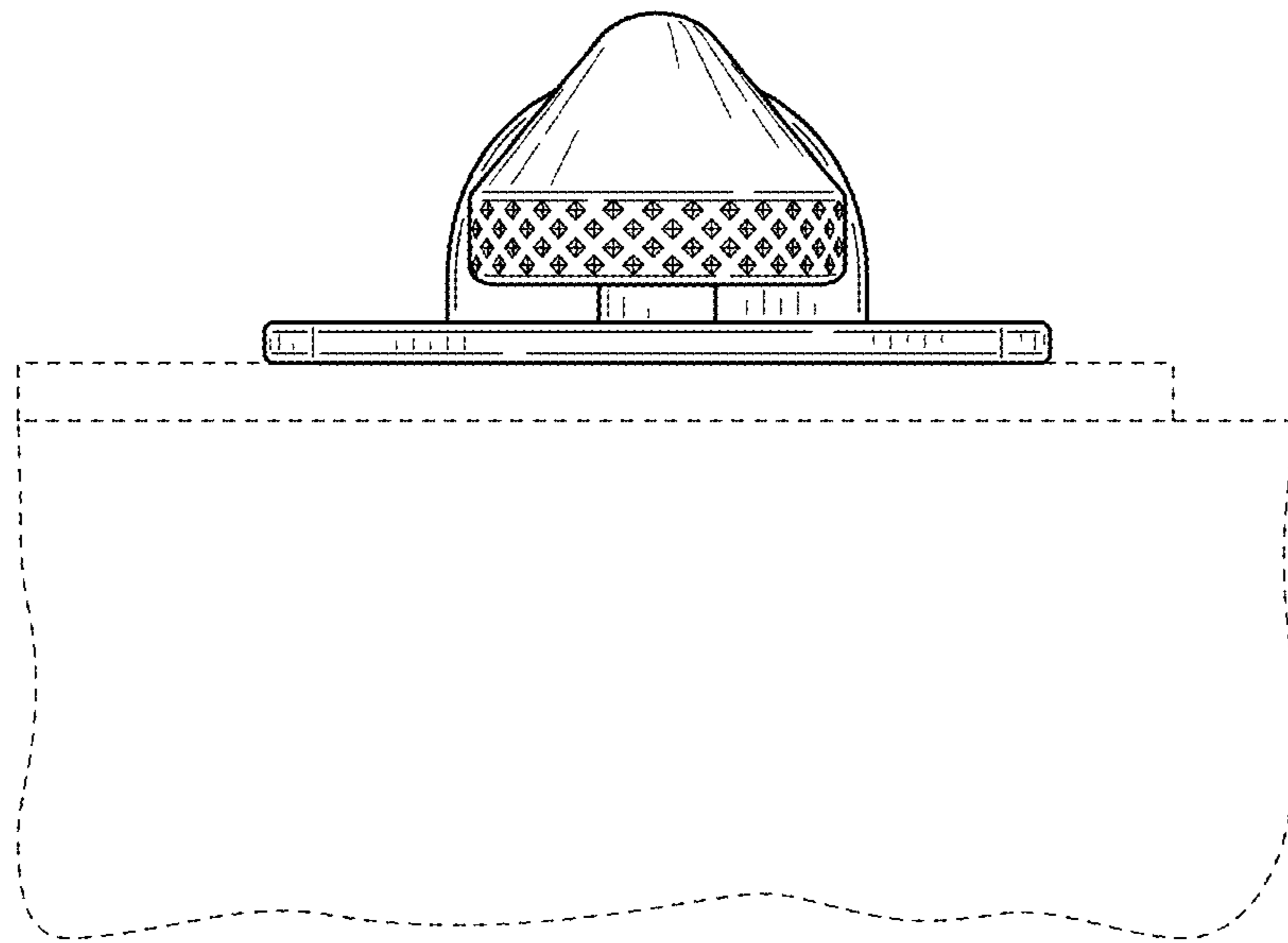

FIG. 4

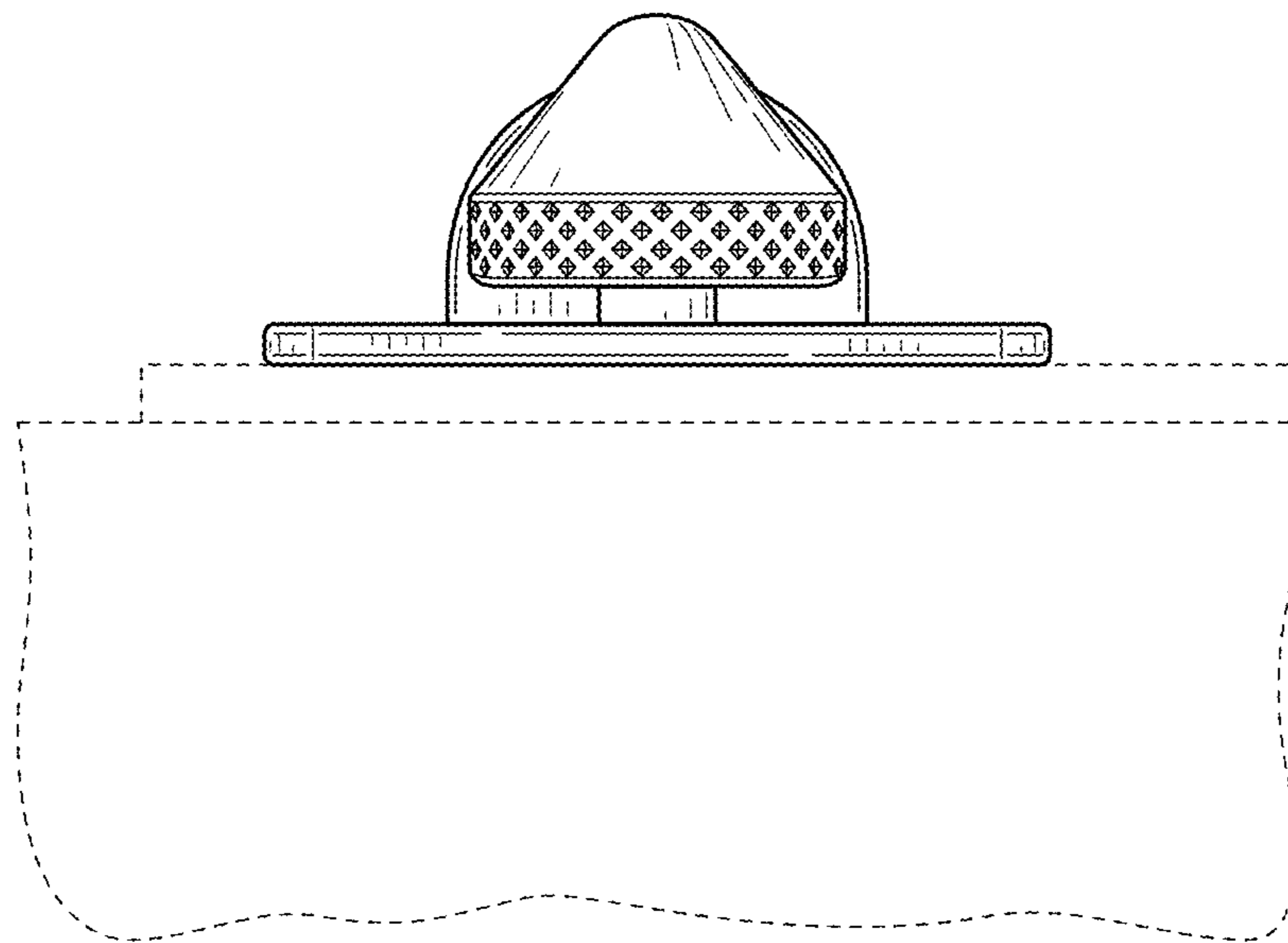

FIG. 5

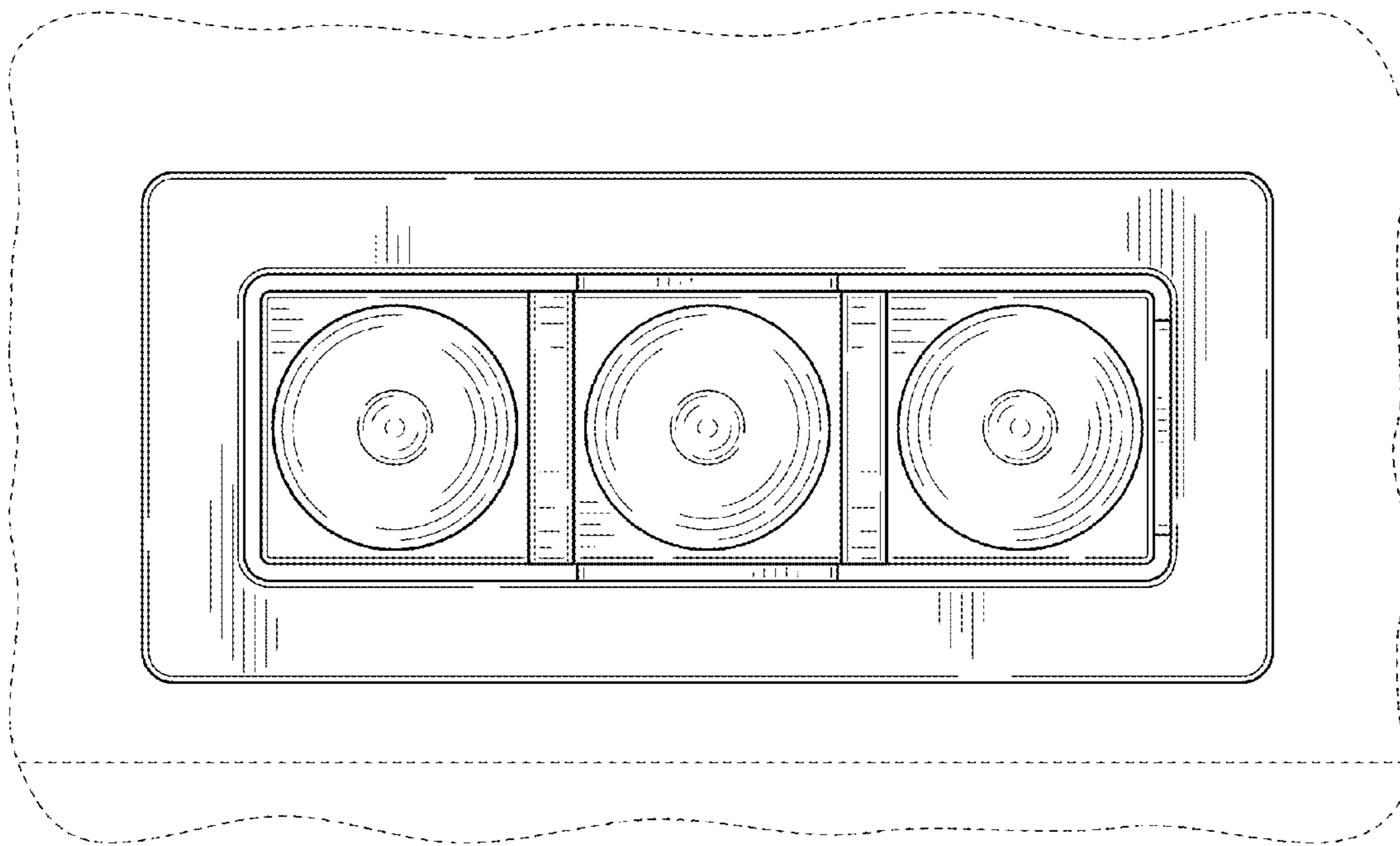

FIG. 6

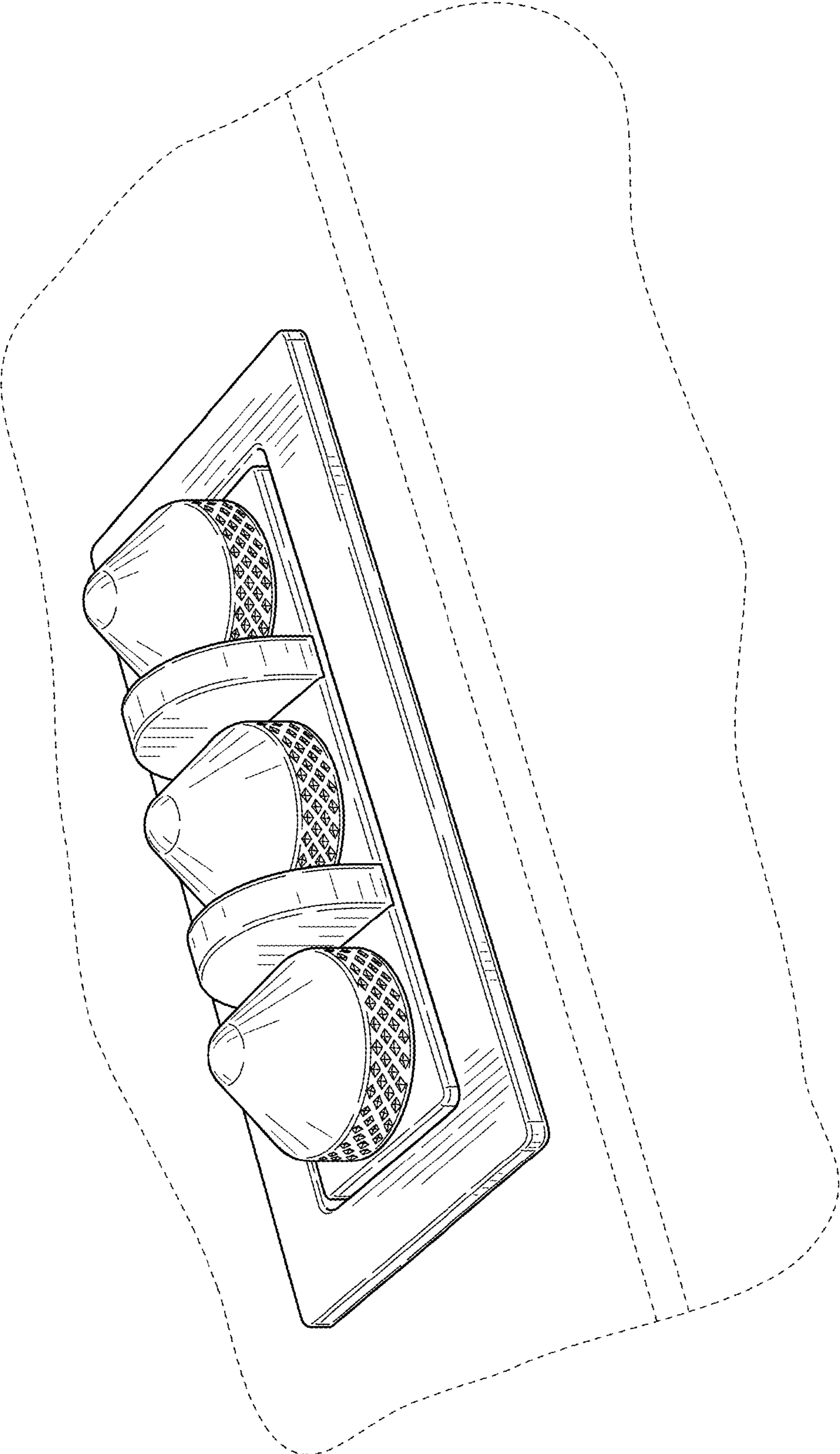

FIG. 7

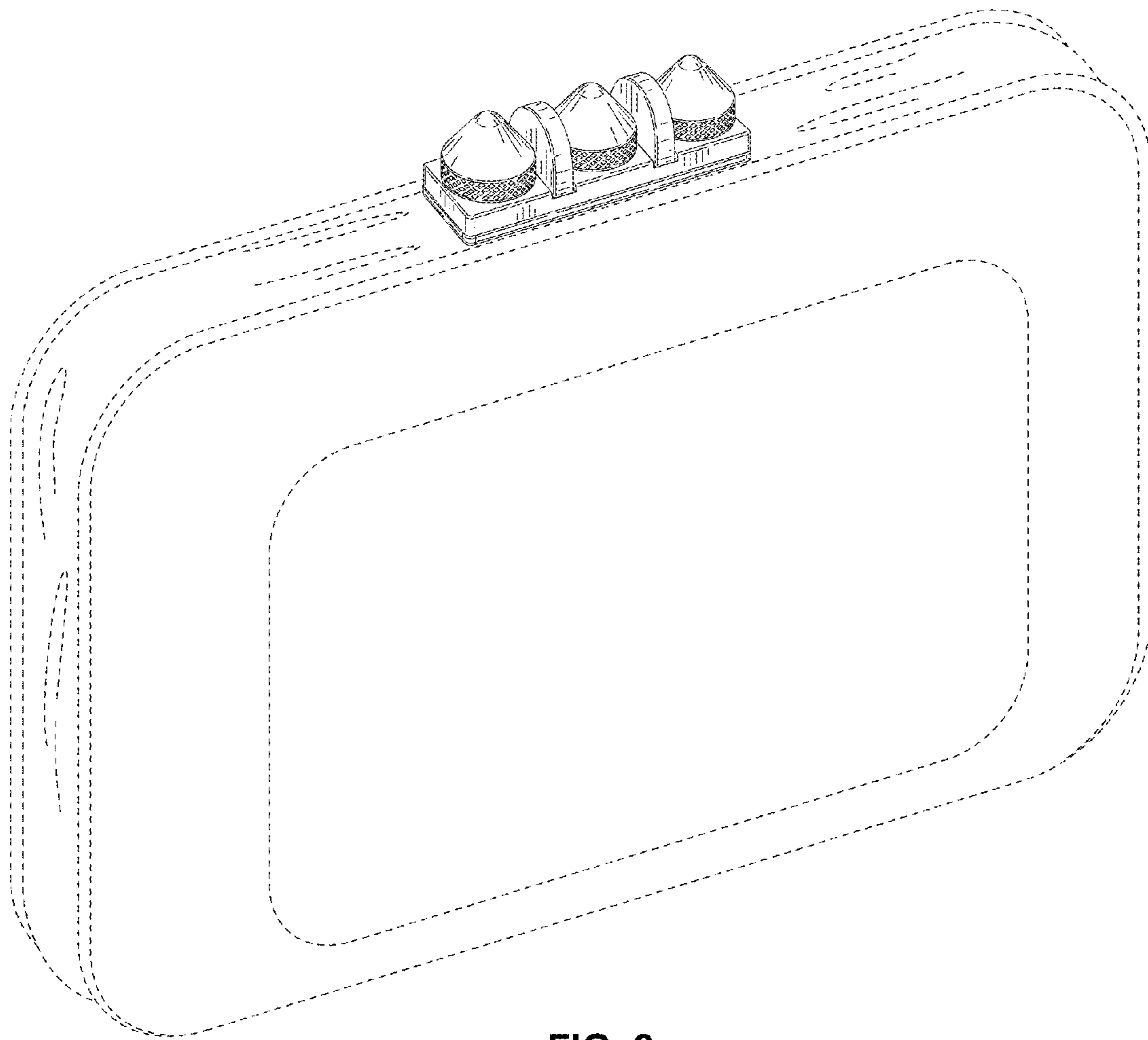

FIG. 8

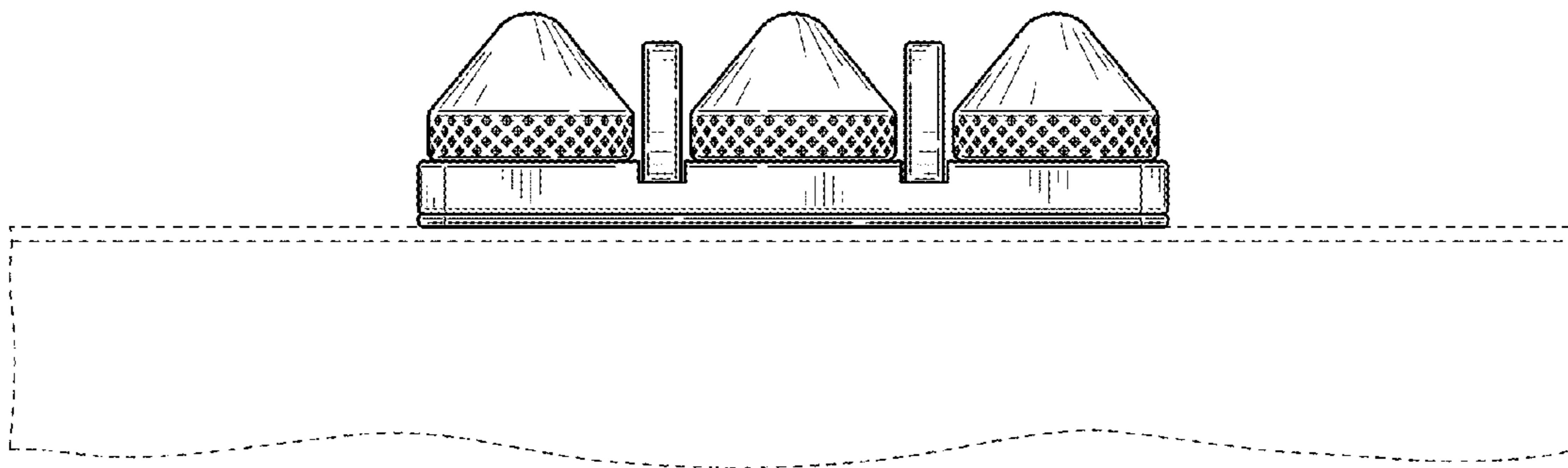

FIG. 9

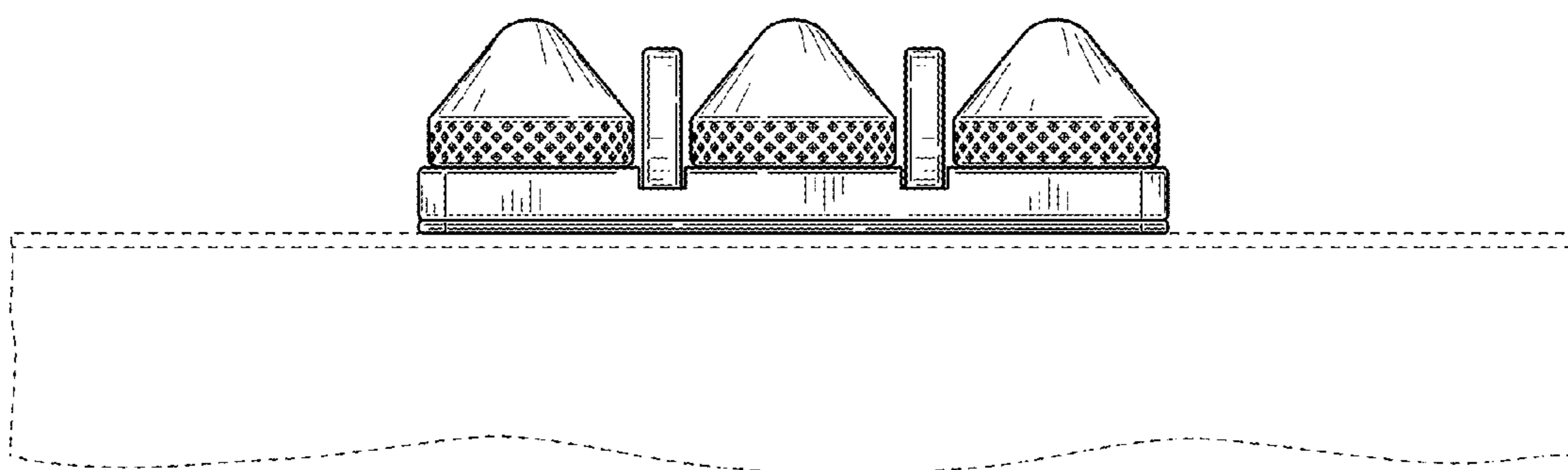

FIG. 10

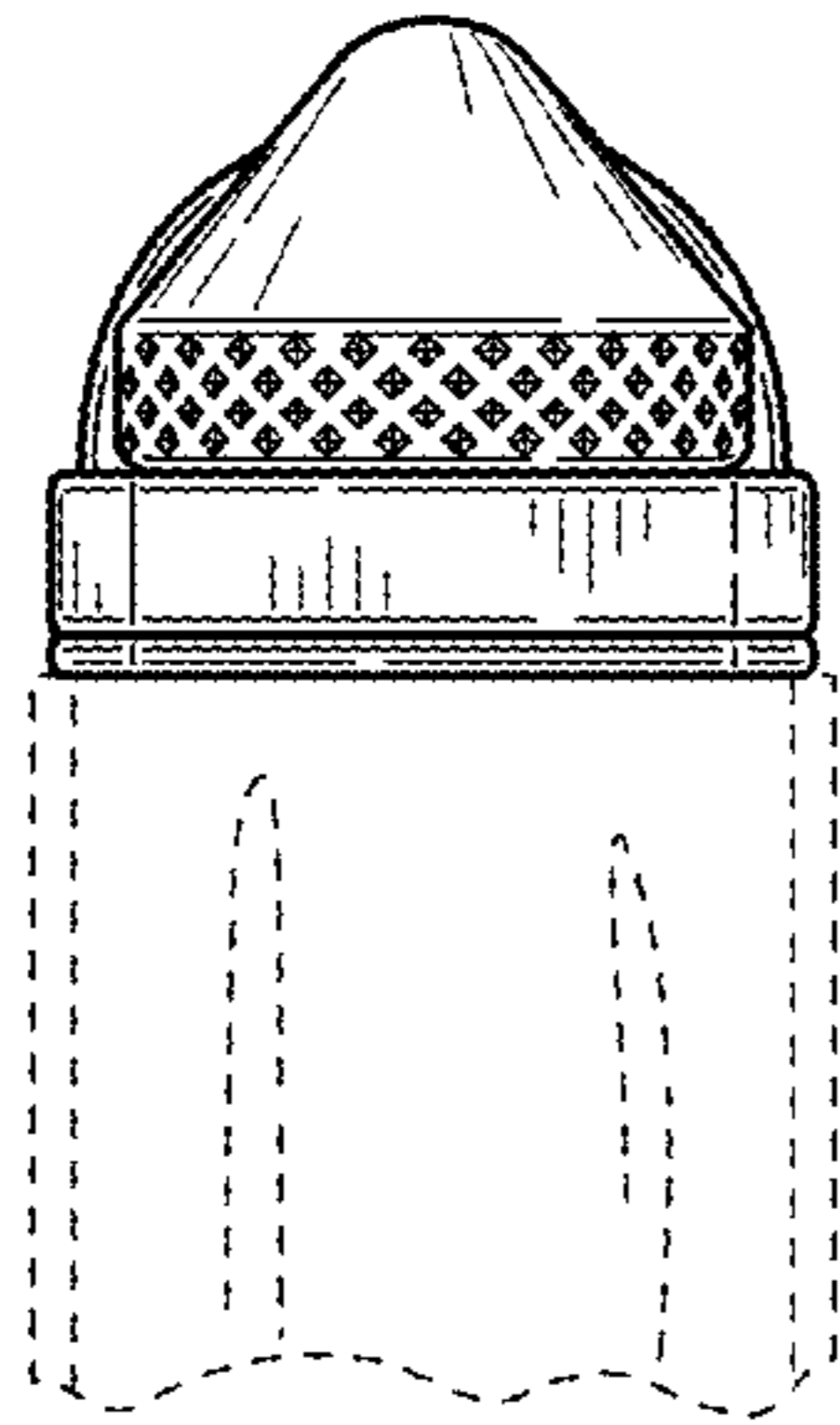

FIG. 11

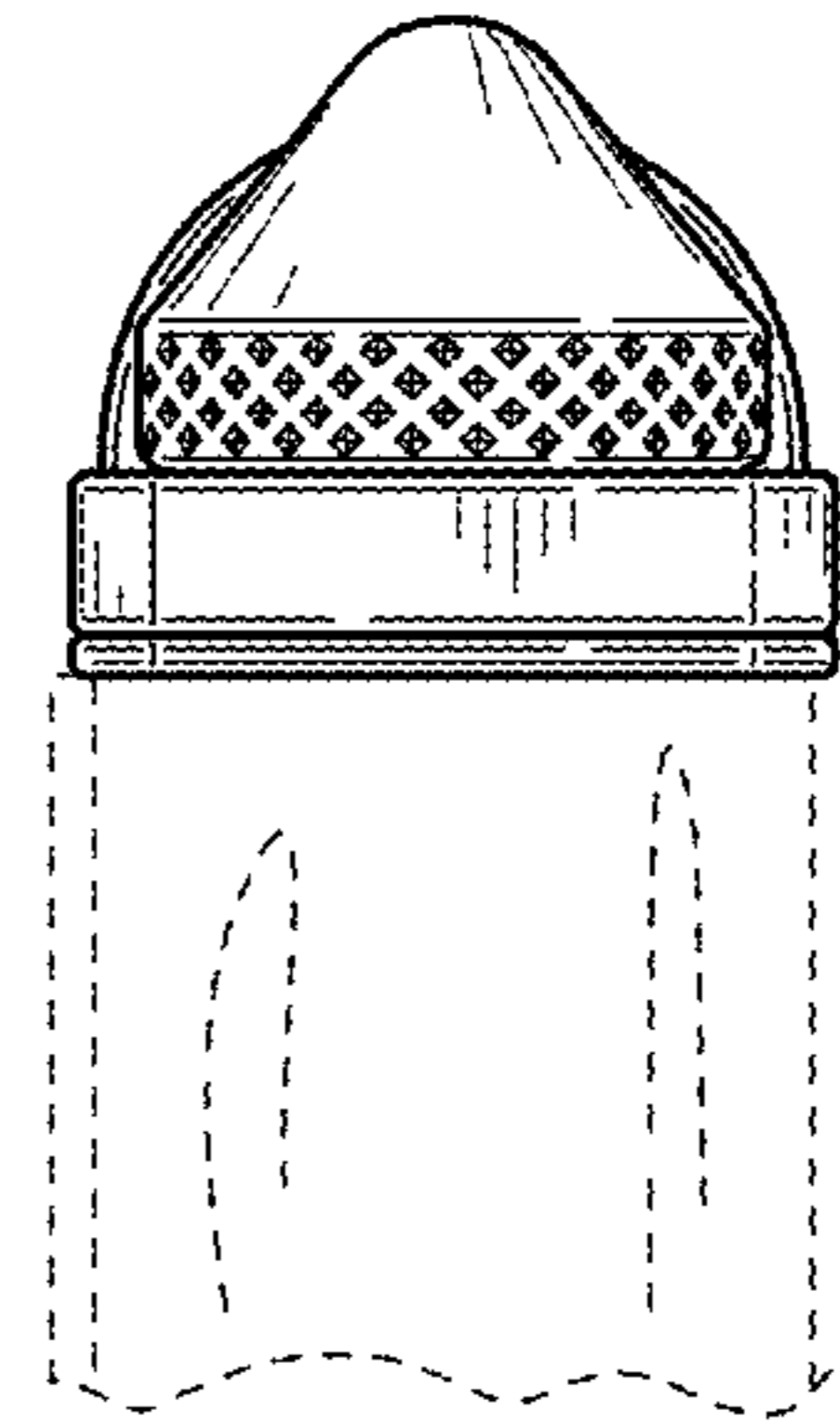

FIG. 12

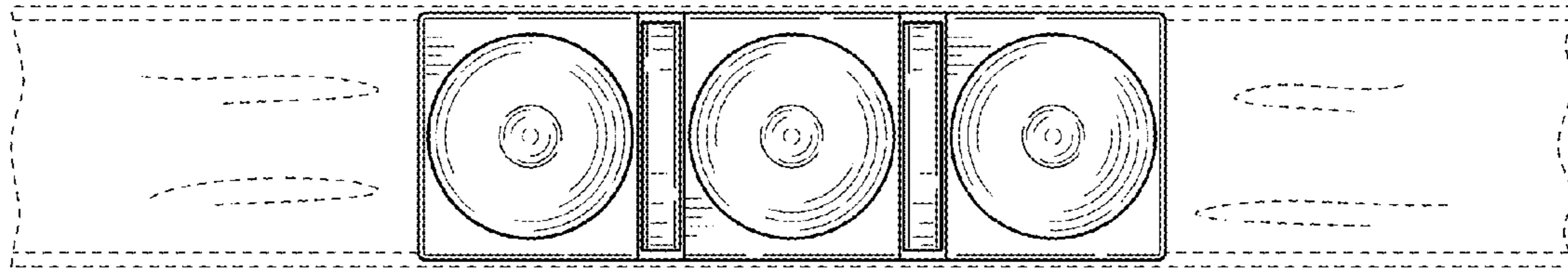

FIG. 13

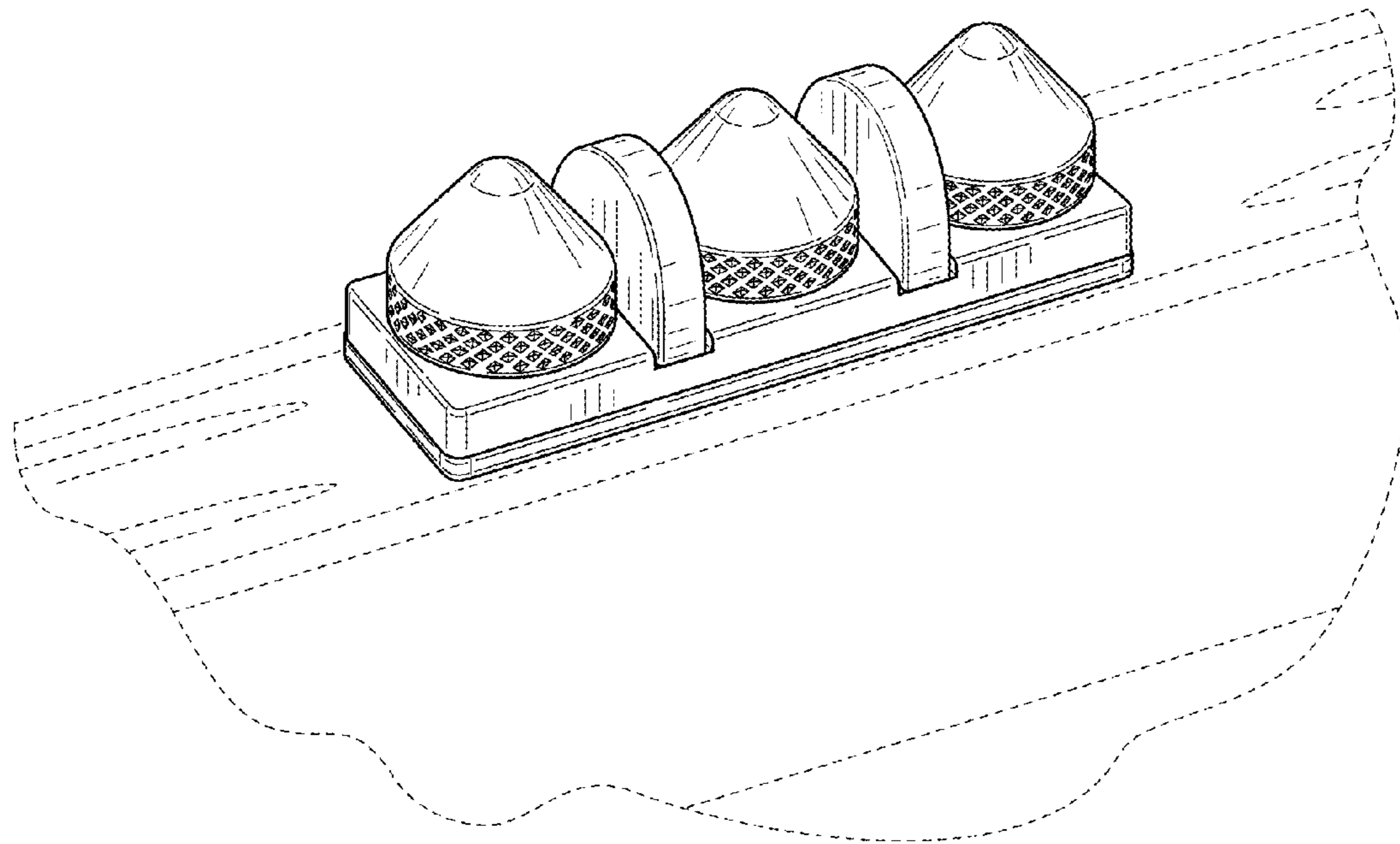

FIG. 14

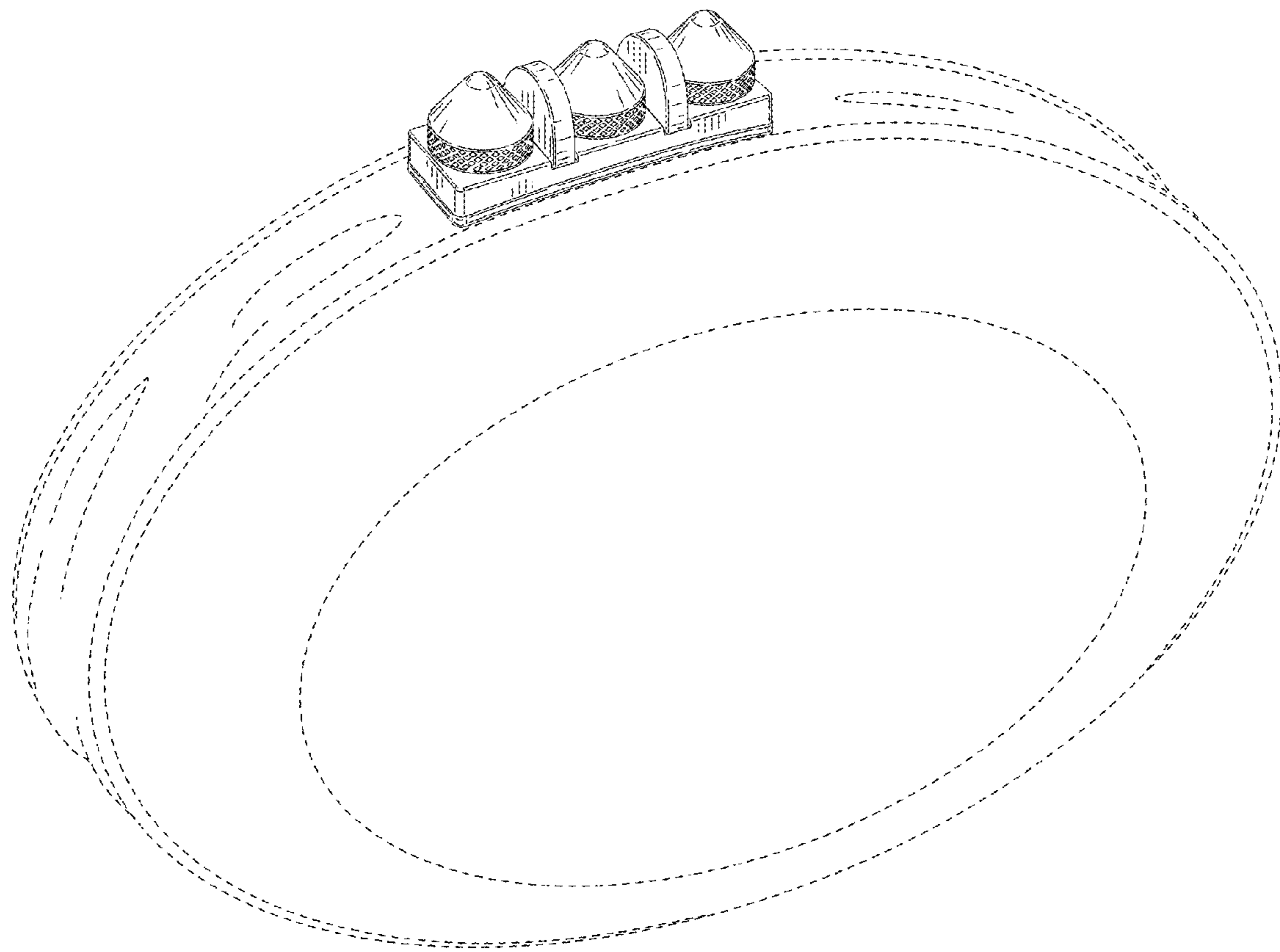

FIG. 15

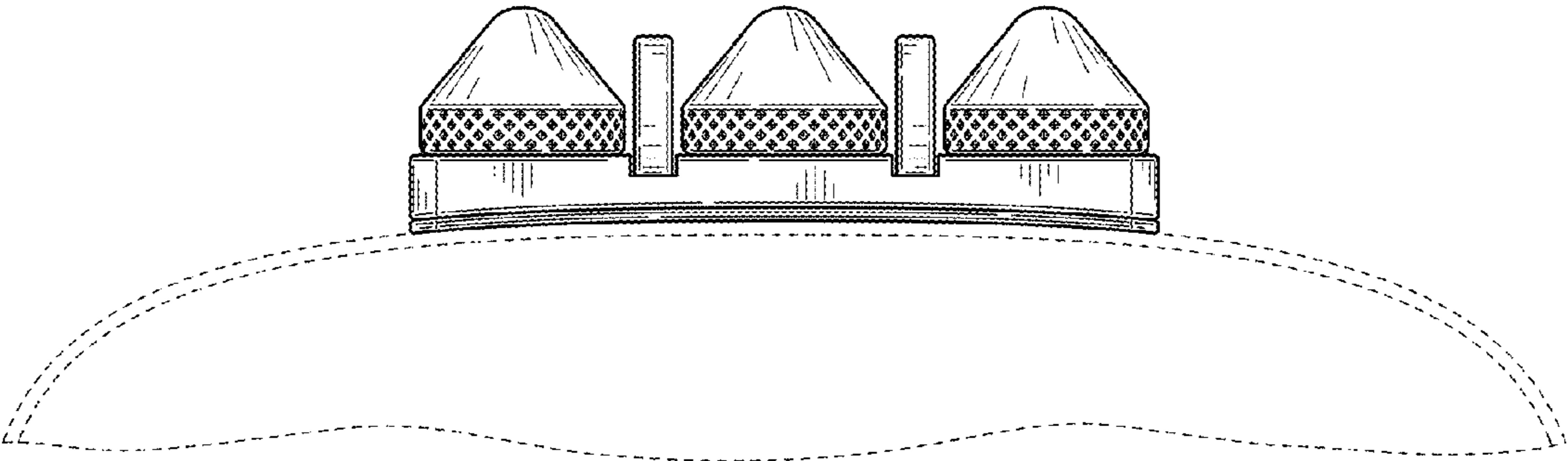

FIG. 16

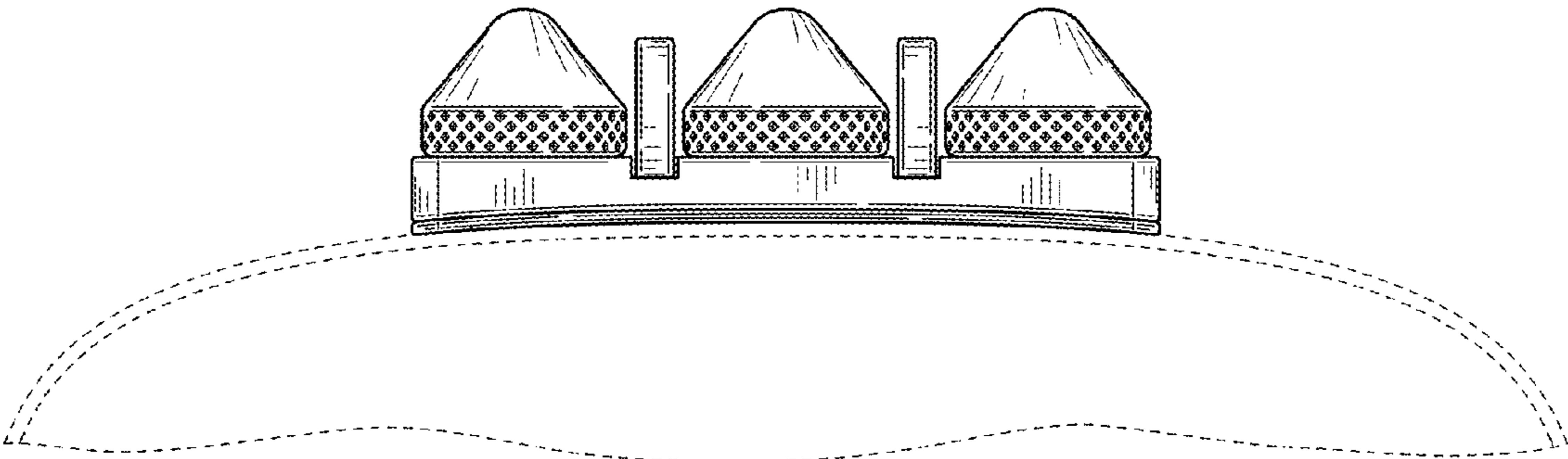

FIG. 17

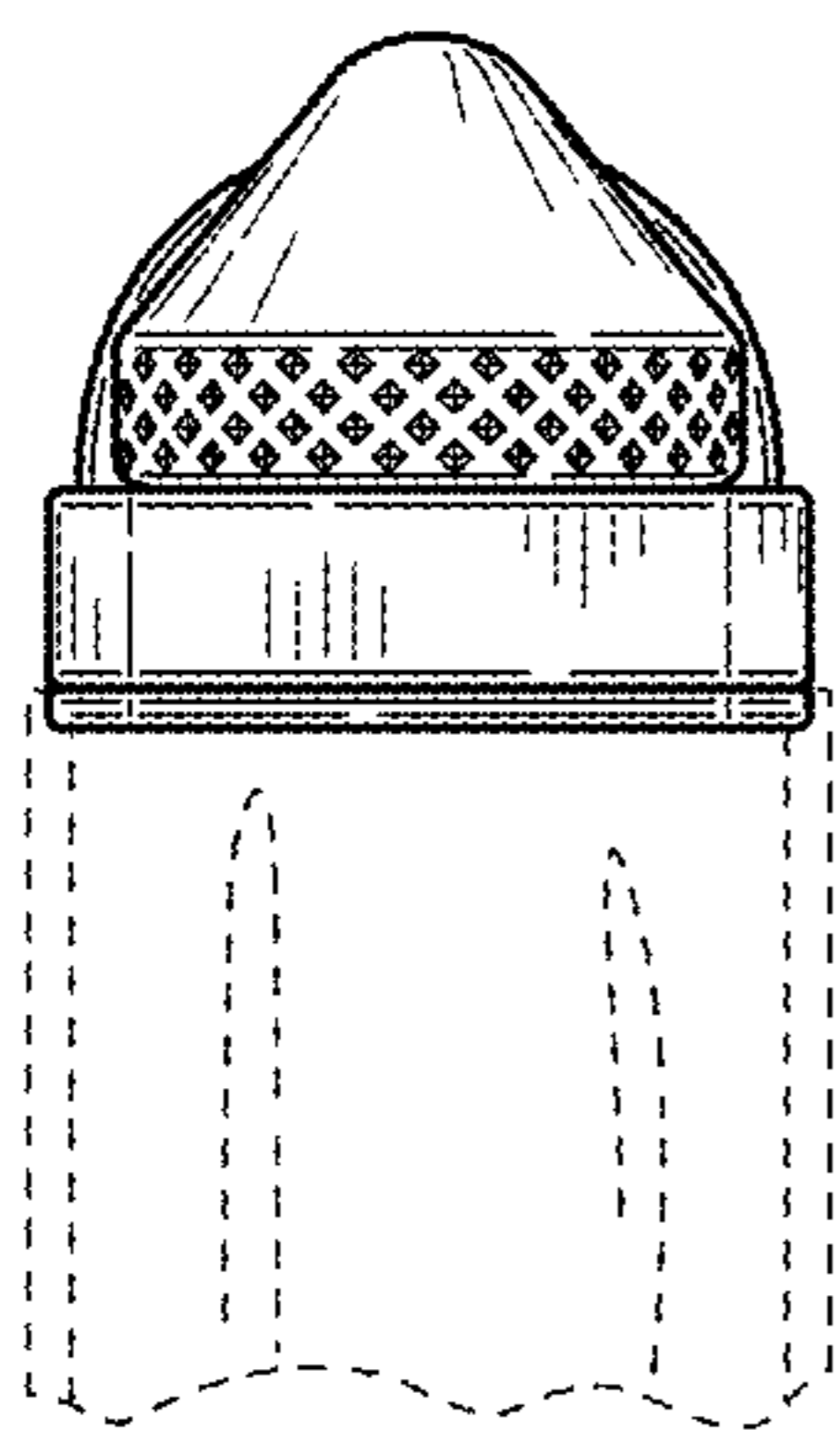

FIG. 18

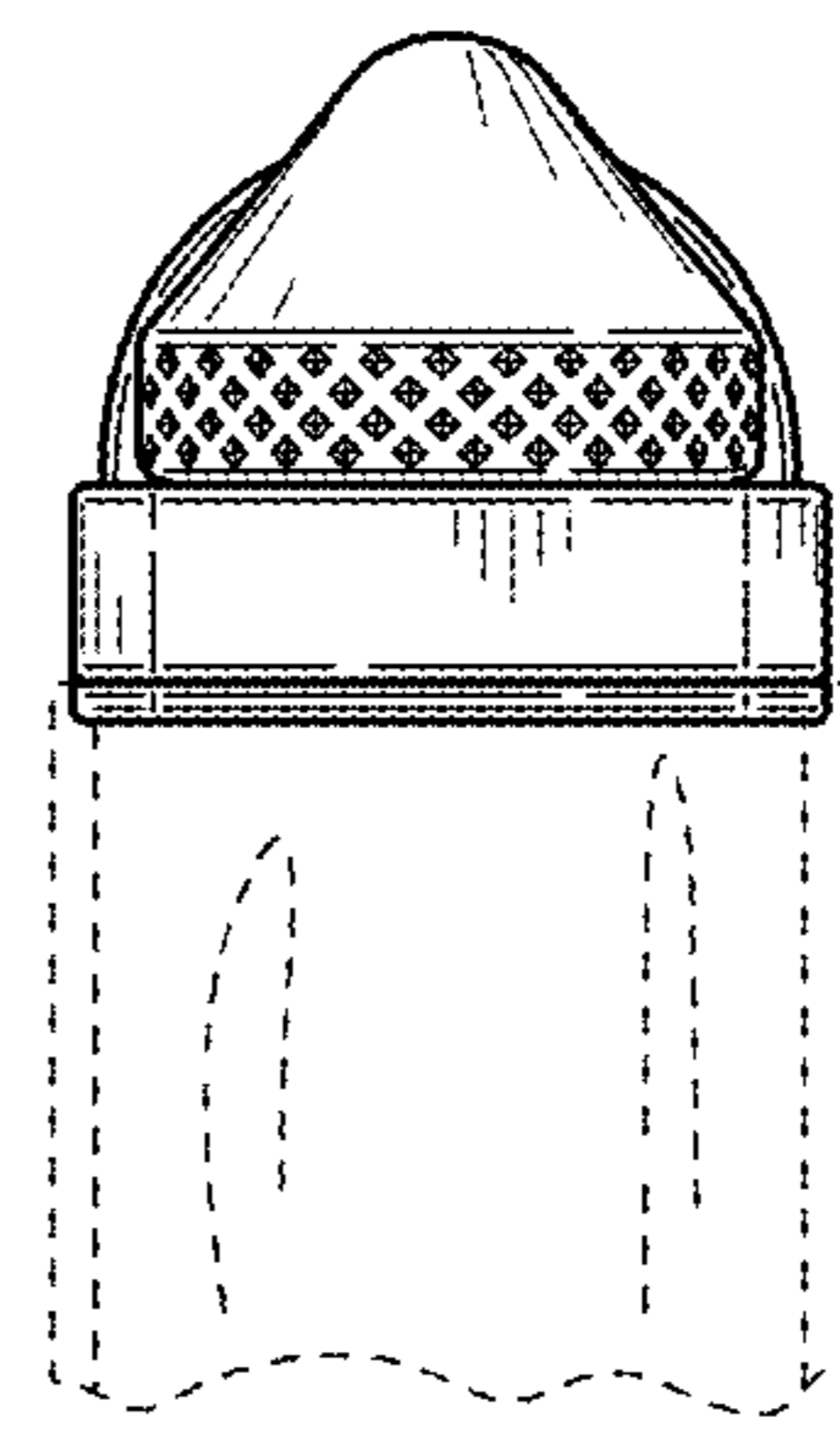

FIG. 19

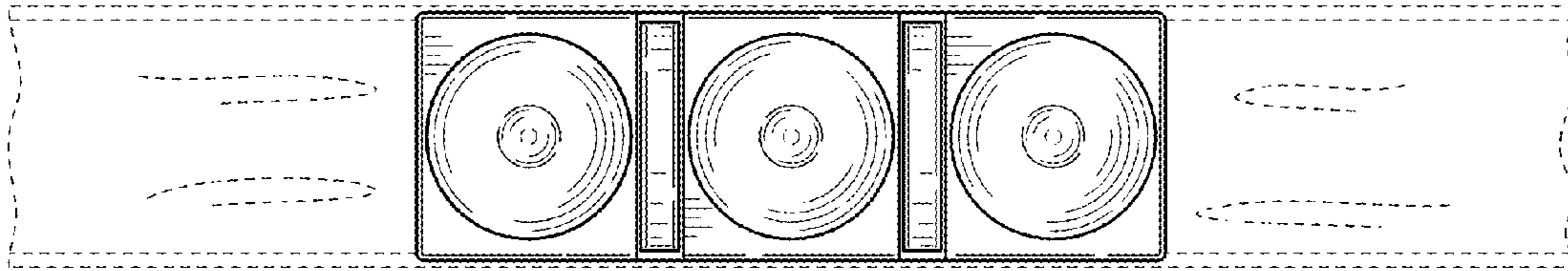

FIG. 20

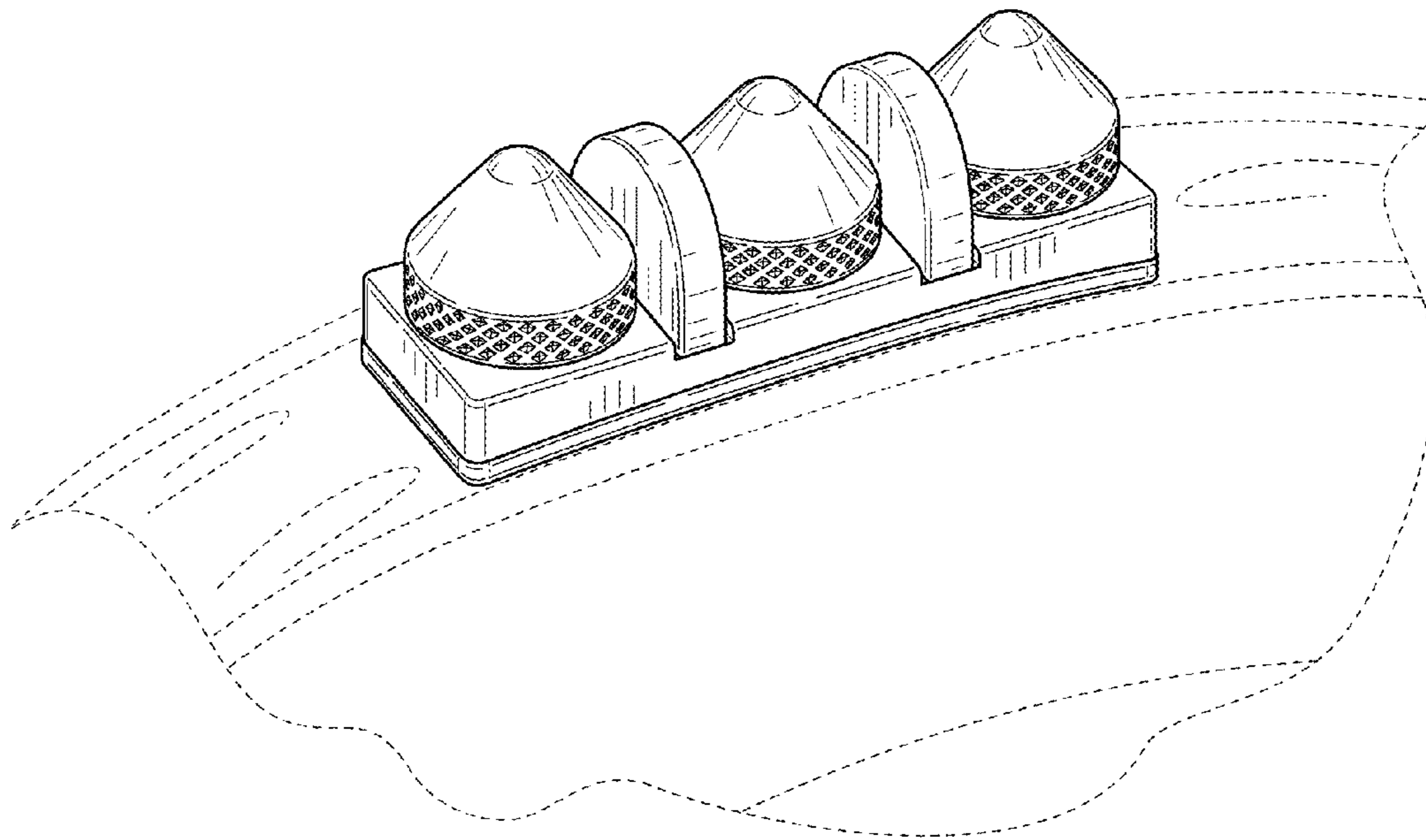

FIG. 21