



US00D698523S

(12) **United States Design Patent**
Roberts et al.

(10) **Patent No.:** **US D698,523 S**
(45) **Date of Patent:** **** Feb. 4, 2014**

- (54) **VEST**
- (71) Applicant: **Gerbings LLC**, Stoneville, NC (US)
- (72) Inventors: **Cupid Roberts**, Stoneville, NC (US);
Susan Kiefer, Greensboro, NC (US)
- (73) Assignee: **Gerbings, LLC**, Stoneville, NC (US)
- (**) Term: **14 Years**
- (21) Appl. No.: **29/458,645**
- (22) Filed: **Jun. 21, 2013**
- (51) **LOC (10) Cl.** **02-02**
- (52) **U.S. Cl.**
USPC **D2/829**
- (58) **Field of Classification Search**
USPC D2/719, 749, 750, 755, 828-831, 833,
D2/839, 840, 847, 849, 858; 2/84, 87, 90,
2/93, 96, 97, 102, 106, 108, 115, 116,
2/125

See application file for complete search history.

(56) **References Cited**

U.S. PATENT DOCUMENTS

4,149,272	A *	4/1979	Maeshima	2/102
5,274,851	A *	1/1994	Simpkins et al.	2/102
6,018,819	A *	2/2000	King et al.	2/69
D539,508	S *	4/2007	Rogers et al.	D2/749
D580,630	S *	11/2008	Adams et al.	D2/829
2004/0143884	A1 *	7/2004	Majerfeld	2/96

OTHER PUBLICATIONS

tjskl.org.cn. http://www.tjskl.org.cn/images/czad43eb-pz24000a7-workwear_softshell_vest.html. Copyright 2011. "Workwear Softshell Vest".*

Haley Vines Outdoor Collection. <http://www.haleyvines.com/soft-shell-vest.html>. Jan. 2012. "Soft Shell Vest".*

Whitecaps. <http://www.whitecapsfoulweathergear.com/atlantis/atlantis-569-grand-prix-softshell-vest/56/115>. Copyright 2013. "Atlantis 569 Grand Prix Softshell Vest".*

Sperry Top-Sider. http://www.sperrytopsider.com/store/SiteController/sperry/Men'sSoftshellVest/7-140080/catId/cat90046DM/stockNumber/STSM-05B/skuId/****7*****STSM-05B00**M/subCatId/cat100052DM/showDefaultOption/true/productdetails. Copyright 2013. "Men's Softshell Vest".*

* cited by examiner

Primary Examiner — Rashida Johnson

(74) *Attorney, Agent, or Firm* — Kutak Rock LLP

(57) **CLAIM**

The ornamental design for a vest, as shown and described.

DESCRIPTION

FIG. 1 is a perspective view of a front and a right side of a vest design;

FIG. 2 is a front elevational view the vest from FIG. 1;

FIG. 3 is a rear elevational view of the vest from FIGS. 1-2;

FIG. 4 is a left side elevational view of the vest from FIGS. 1-3;

FIG. 5 is a right side elevational view of the vest from FIGS. 1-4;

FIG. 6 is a top plan view of the vest from FIGS. 1-5; and,

FIG. 7 is a bottom plan view of the vest from FIGS. 1-6.

The broken lines are for the purposes of illustrating environment only. None of the broken lines form part of the claimed design.

1 Claim, 5 Drawing Sheets

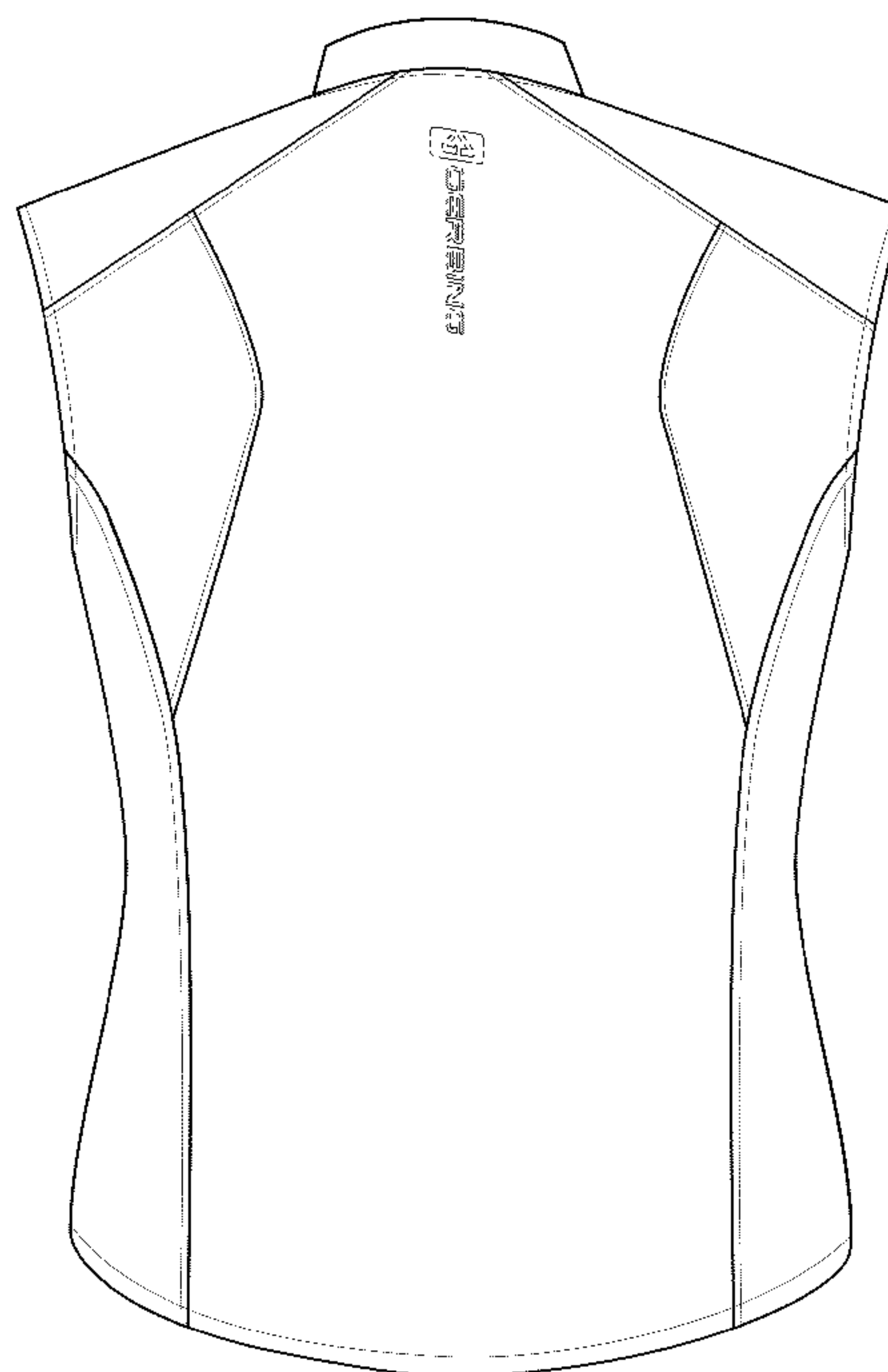
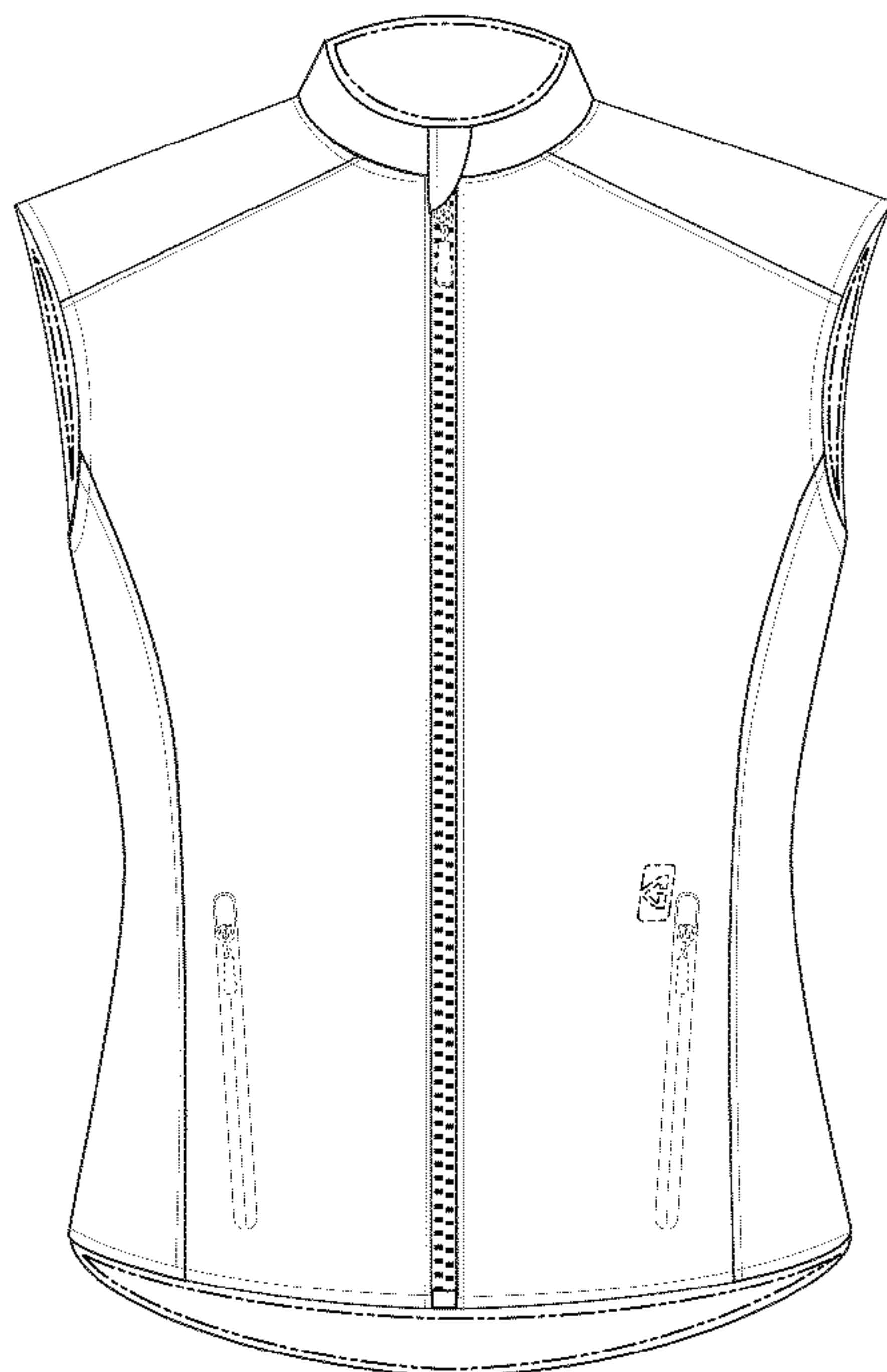

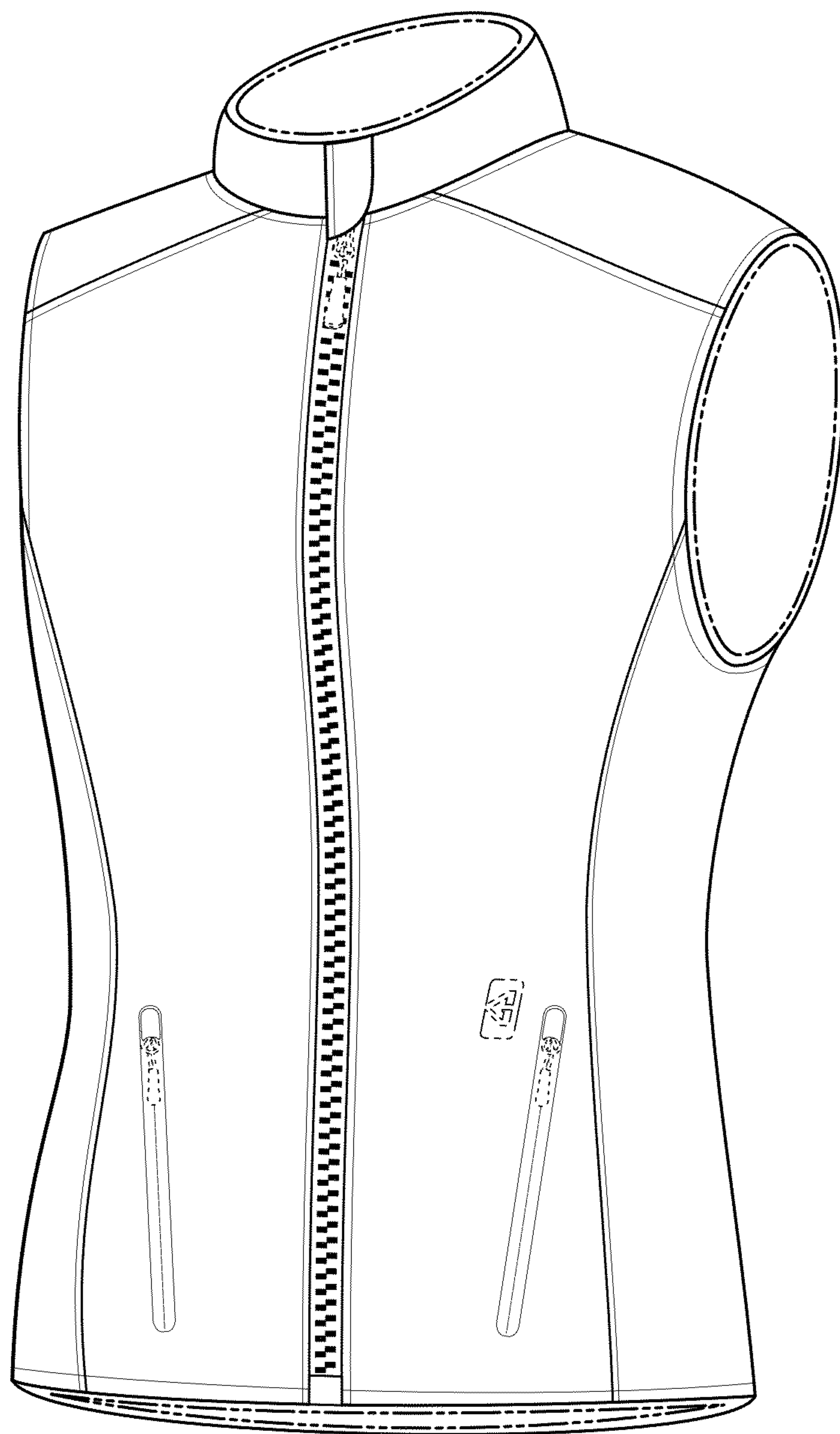

Figure 1

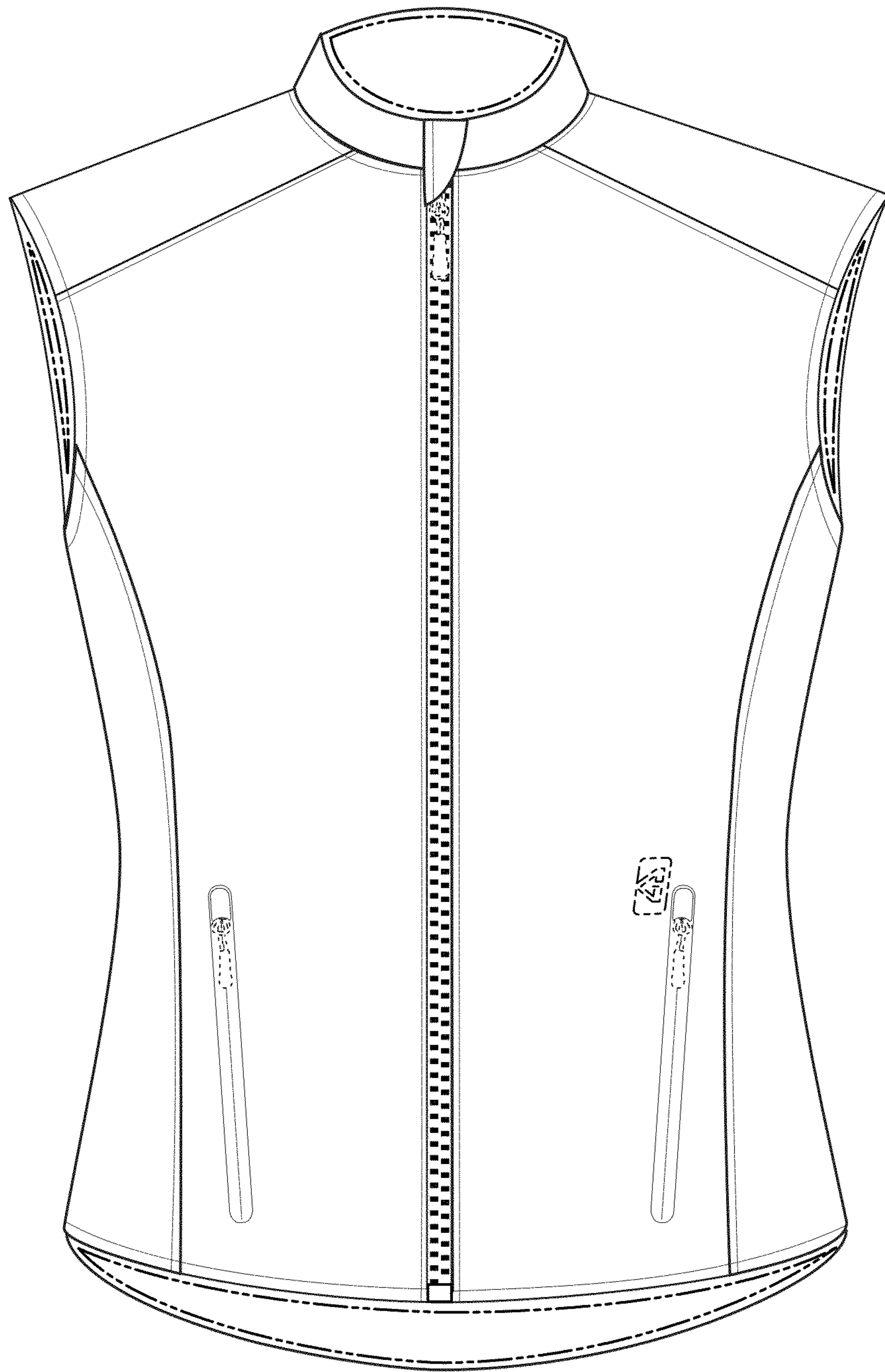

Figure 2

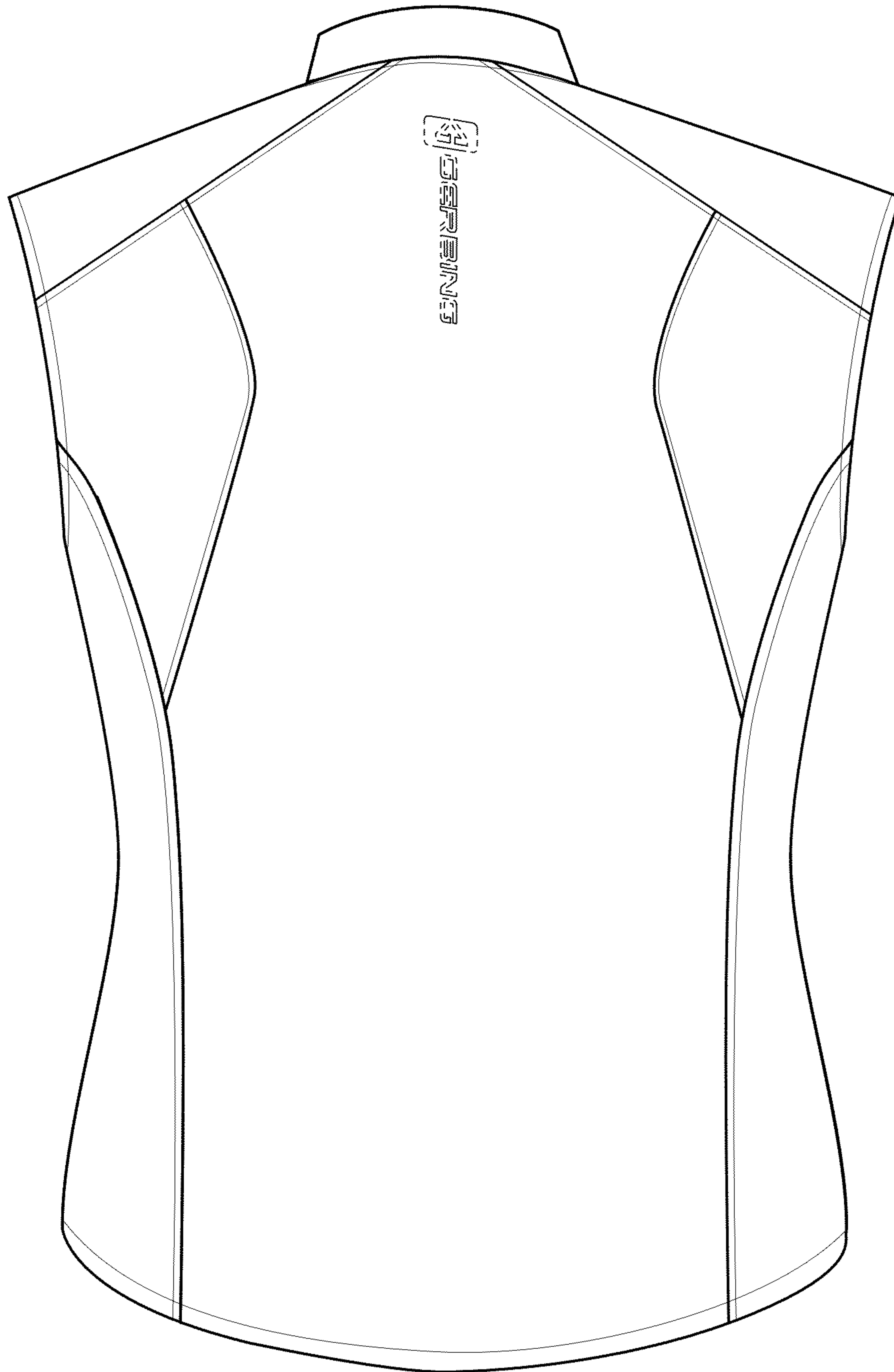

Figure 3

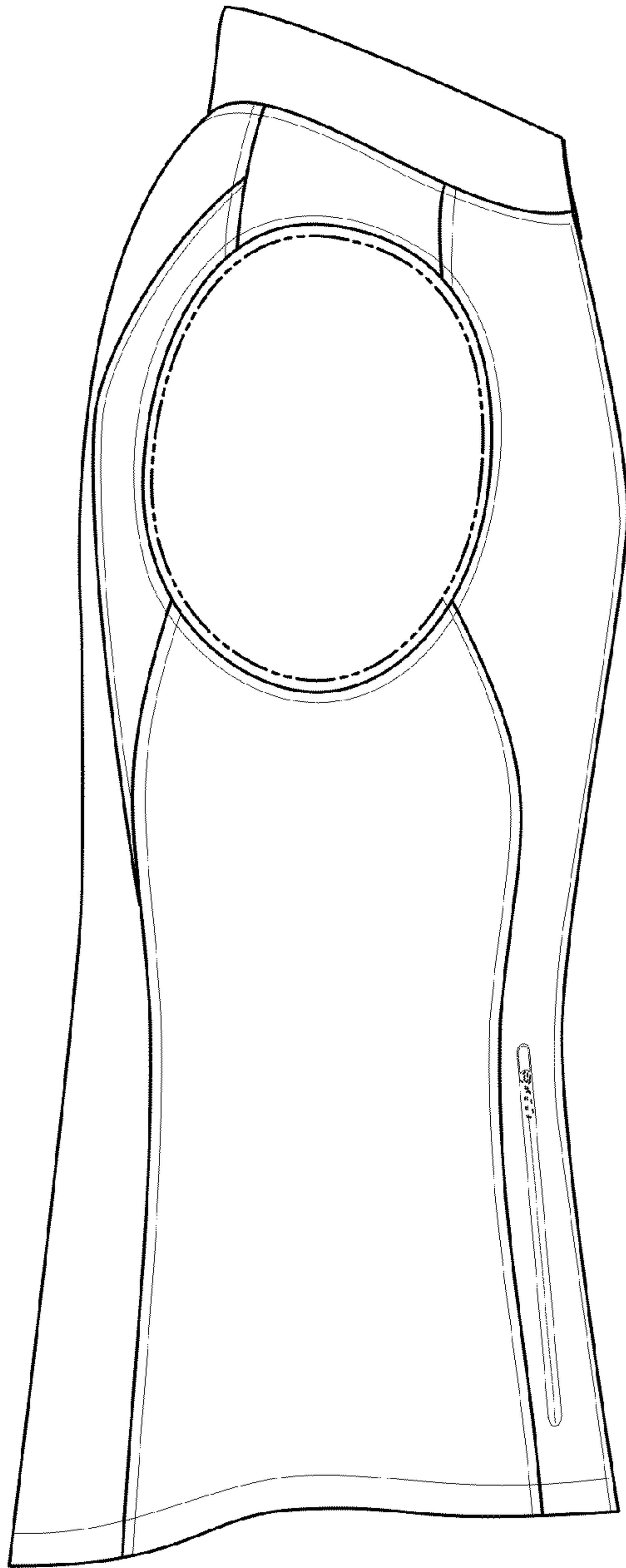

Figure 4

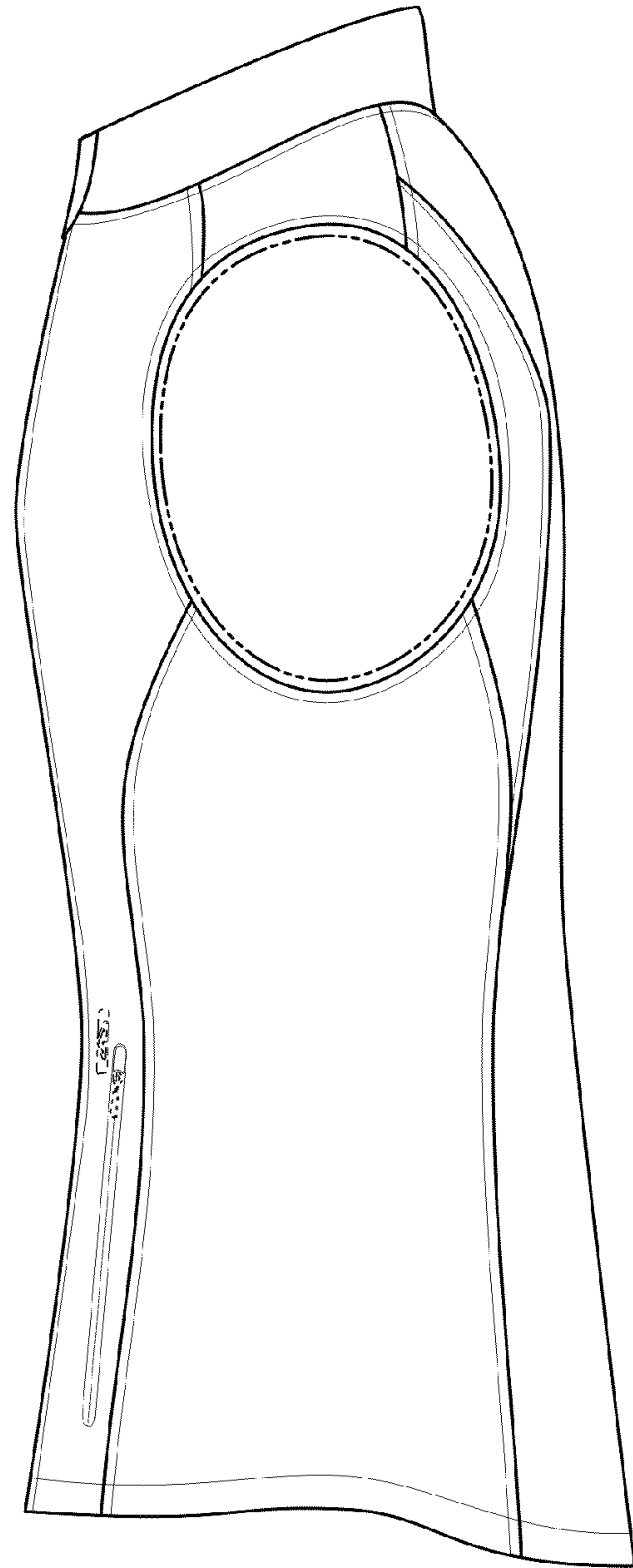

Figure 5

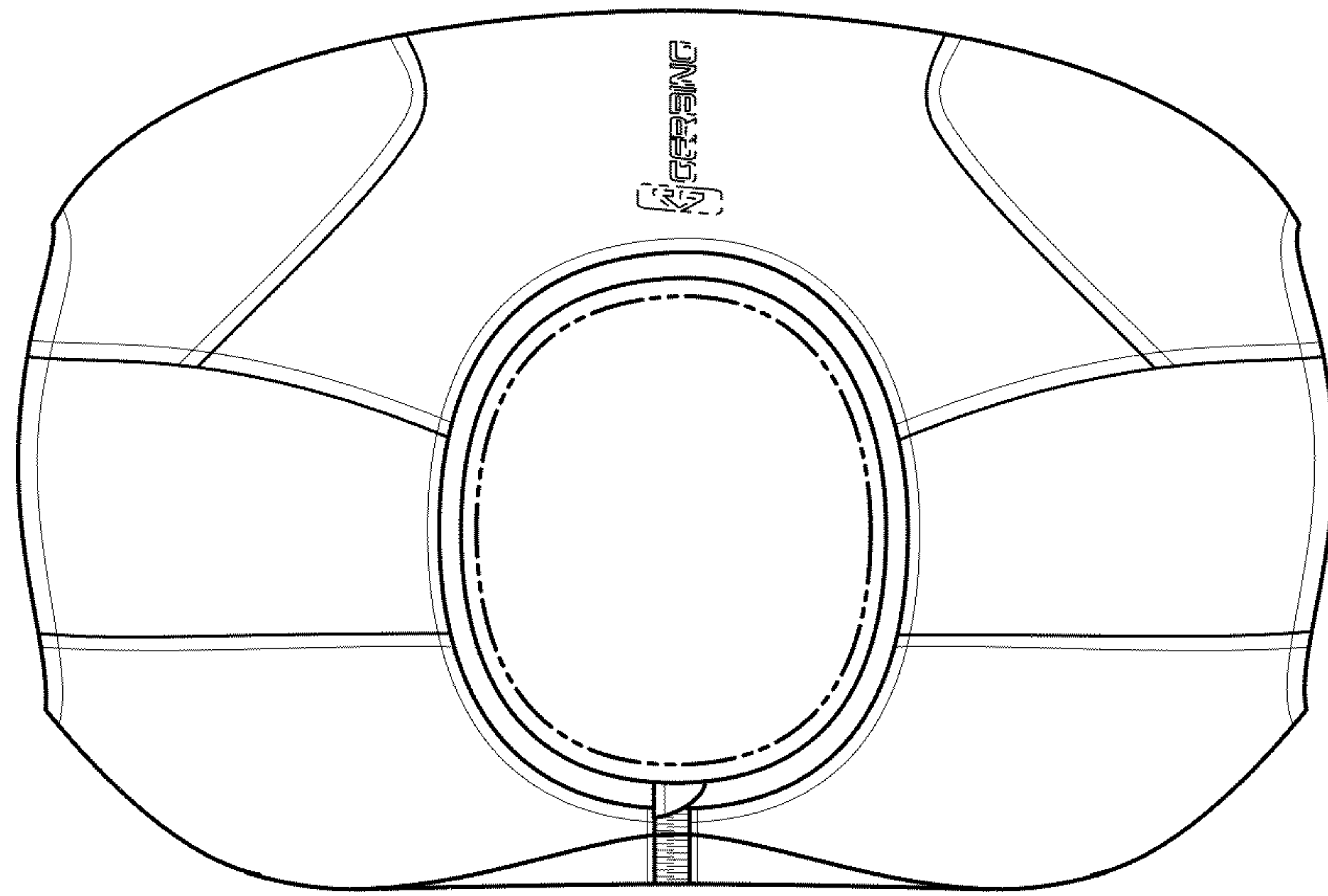

Figure 6

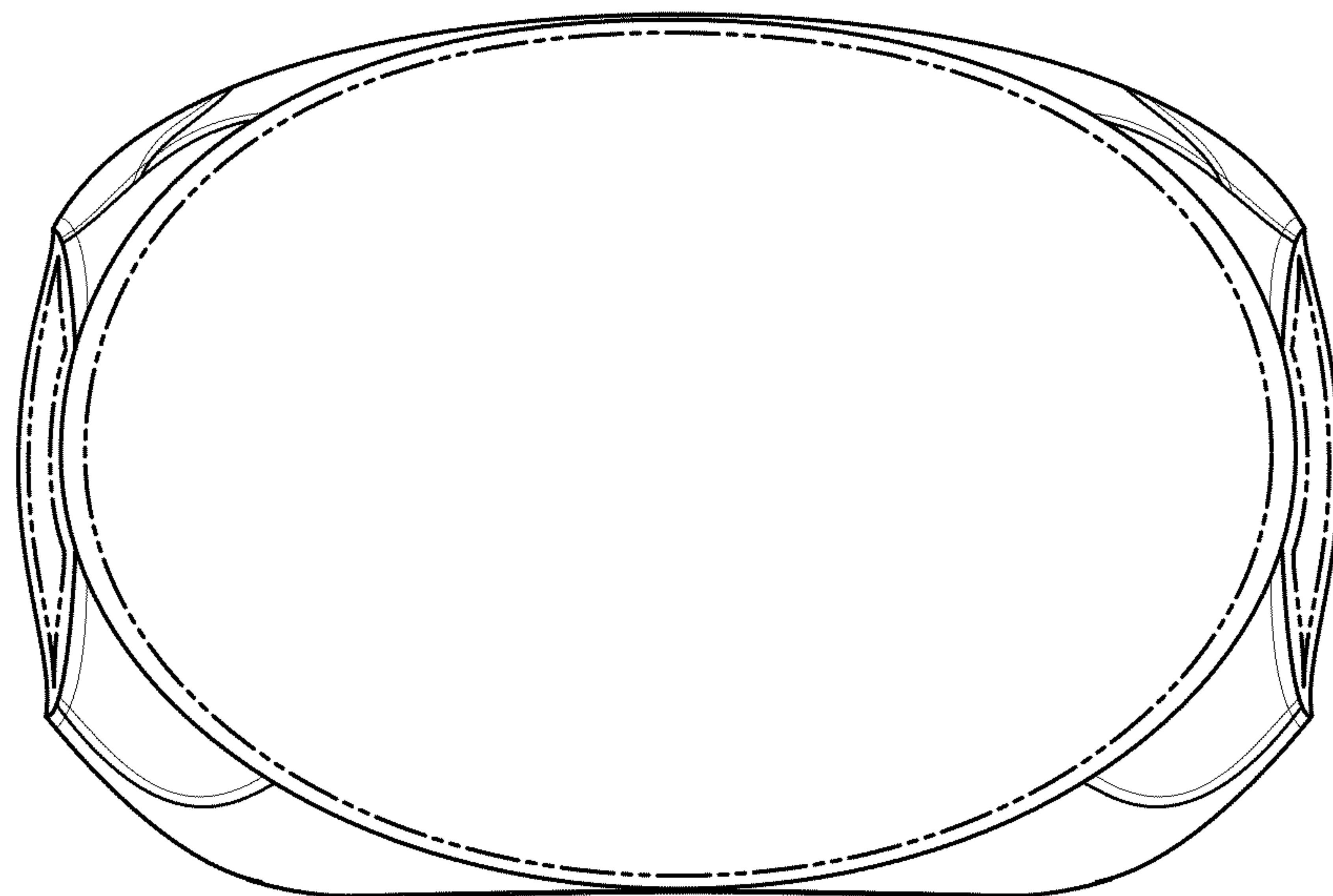

Figure 7