



US00D698170S

(12) **United States Design Patent**
Caldwell

(10) **Patent No.:** **US D698,170 S**
(45) **Date of Patent:** **** Jan. 28, 2014**

(54) **CHAIR**

(71) Applicant: **John Caldwell**, San Marino, CA (US)

(72) Inventor: **John Caldwell**, San Marino, CA (US)

(**) Term: **14 Years**

(21) Appl. No.: **29/454,291**

(22) Filed: **May 8, 2013**

(51) **LOC (10) Cl.** **06-01**

(52) **U.S. Cl.**
USPC **D6/370**

(58) **Field of Classification Search**
USPC 297/232, 411.4, 411.41, 411.42, 440.1,
297/445.1, 446.1, 452.48, 452.63
See application file for complete search history.

(56) **References Cited**

U.S. PATENT DOCUMENTS

D215,929	S	*	11/1969	Guillon	D6/334
D222,051	S	*	9/1971	Shannon	D6/381
D229,591	S	*	12/1973	Trail et al.	D6/370
D239,228	S	*	3/1976	Introini	D6/364
D252,427	S	*	7/1979	Beall	D6/364
D263,770	S	*	4/1982	Melchior	D6/334
D288,748	S	*	3/1987	Klein	D6/375
D380,095	S	*	6/1997	Diaz-Azcuy	D6/334
D487,988	S	*	4/2004	Hutton	D6/370
D512,234	S	*	12/2005	Spector et al.	D6/370
D572,030	S	*	7/2008	Lowsky	D6/369
D677,911	S	*	3/2013	Hamilton et al.	D6/334
2013/0147244	A1	*	6/2013	Carter, III	297/452.48

* cited by examiner

Primary Examiner — Mimoso De

(74) *Attorney, Agent, or Firm* — Lott & Fischer, PL

(57) **CLAIM**

The ornamental design for a chair, substantially as shown and described.

DESCRIPTION

FIG. 1 is a front perspective view of my new design;
 FIG. 2 is a front elevational view of the design of FIG. 1;
 FIG. 3 is a rear elevational view of the design of FIG. 1;
 FIG. 4 is a left side elevational view of the design of FIG. 1;
 FIG. 5 is a right side elevational view of the design of FIG. 1;
 FIG. 6 is a top view of the design of FIG. 1;
 FIG. 7 is a bottom view of the design of FIG. 1;
 FIG. 8 is a front perspective view of the design of FIG. 1 with cushions removed;
 FIG. 9 is a front elevational view of the design of FIG. 1 with cushions removed;
 FIG. 10 is a rear elevational view of the design of FIG. 1 with cushions removed;
 FIG. 11 is a left side elevational view of the design of FIG. 1 with cushions removed;
 FIG. 12 is a right side elevational view of the design of FIG. 1 with cushions removed;
 FIG. 13 is a top view of the design of FIG. 1 with cushions removed; and,
 FIG. 14 is a bottom view of the design of FIG. 1 with cushions removed.
 FIGS. 8-14 are shown without cushions for ease of illustration.

1 Claim, 14 Drawing Sheets

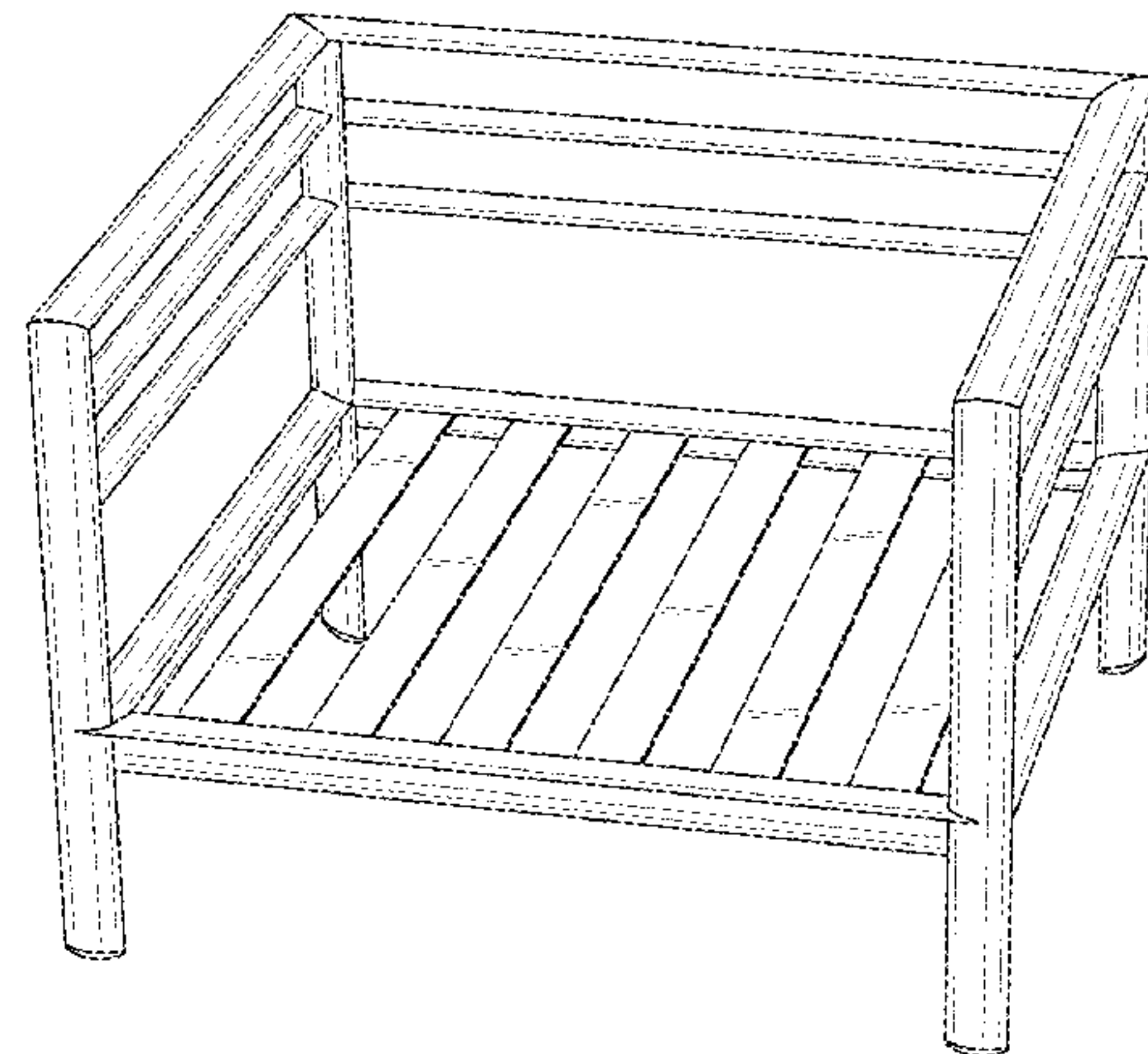
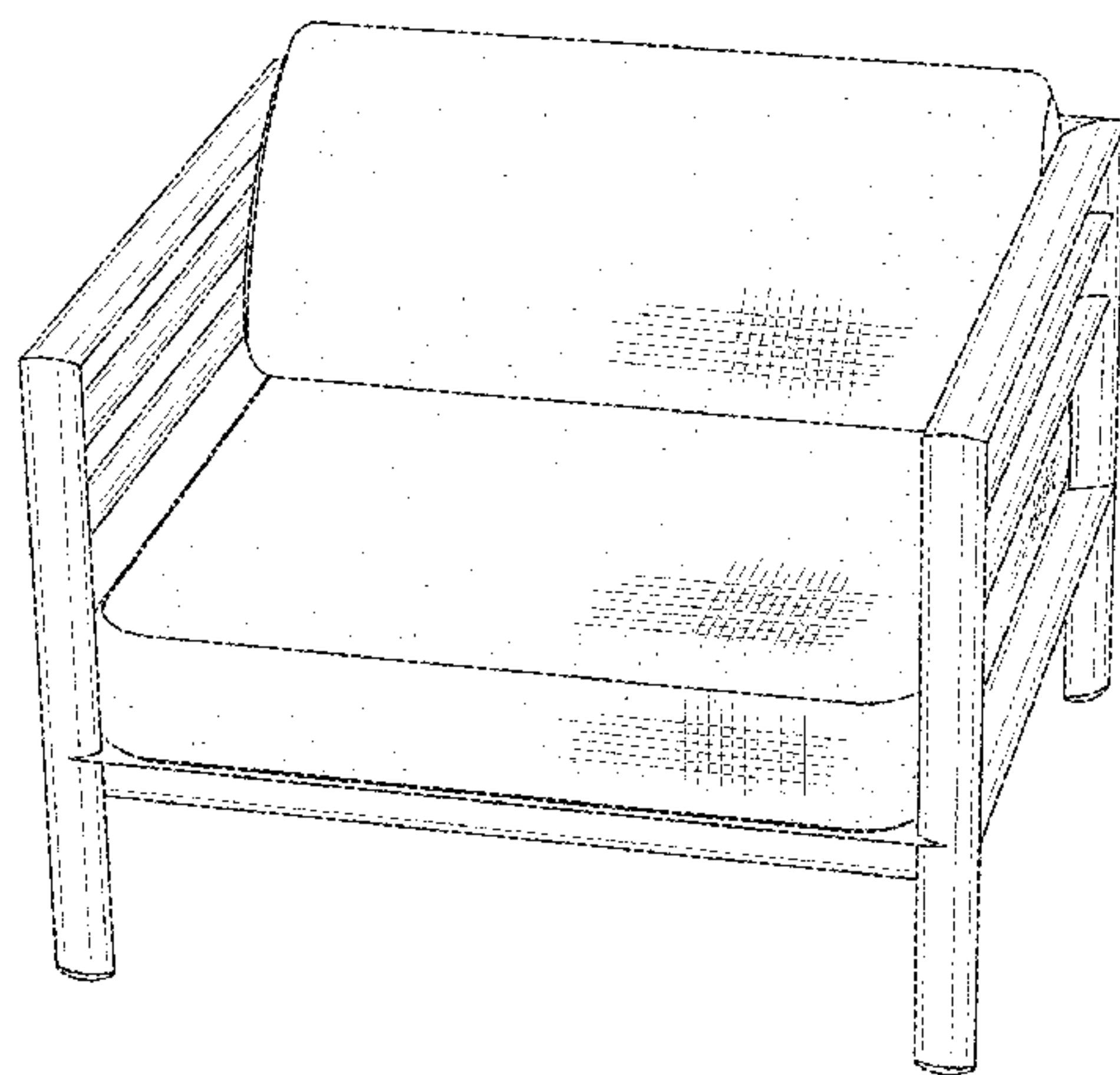

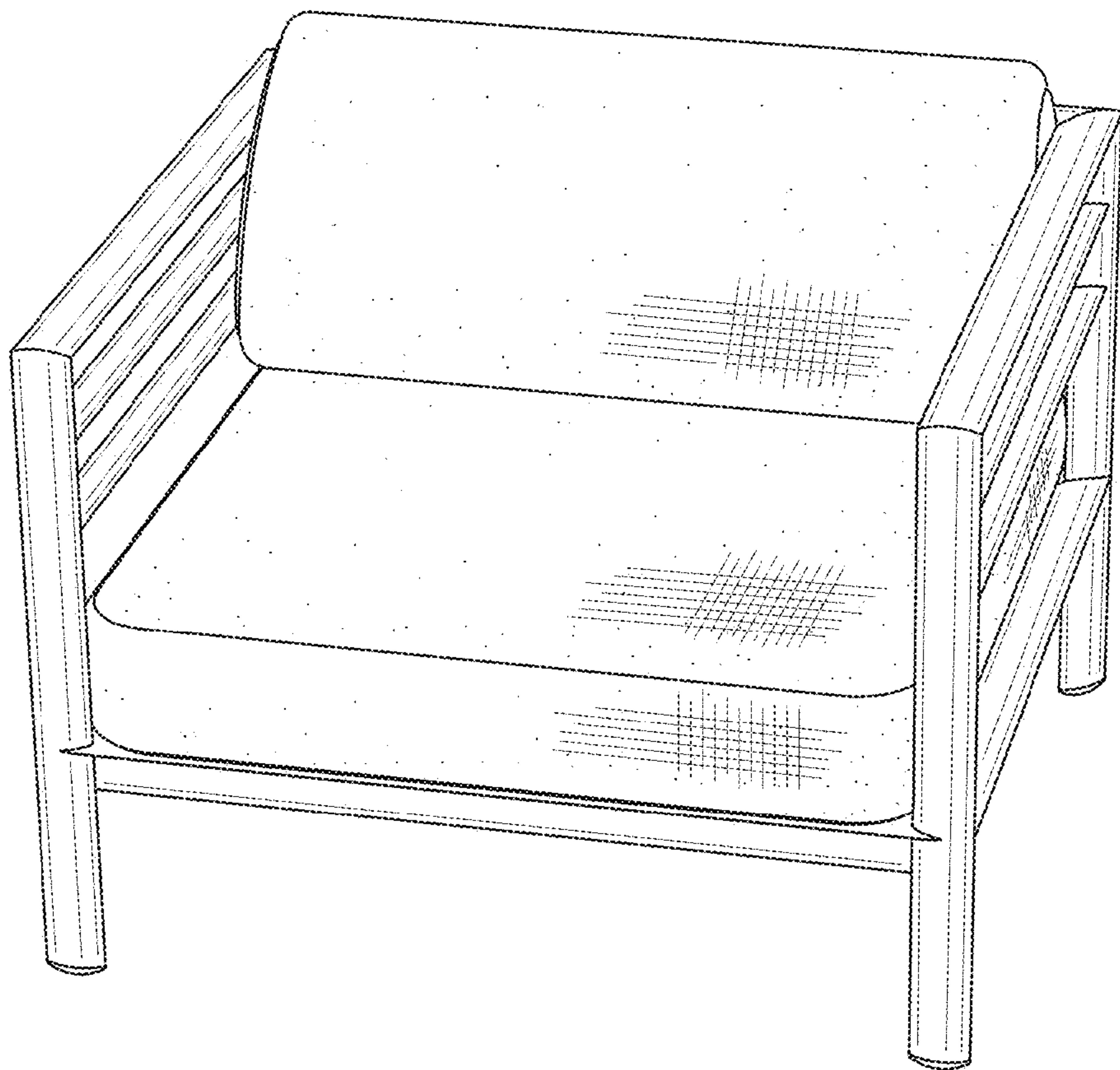

FIG. 1

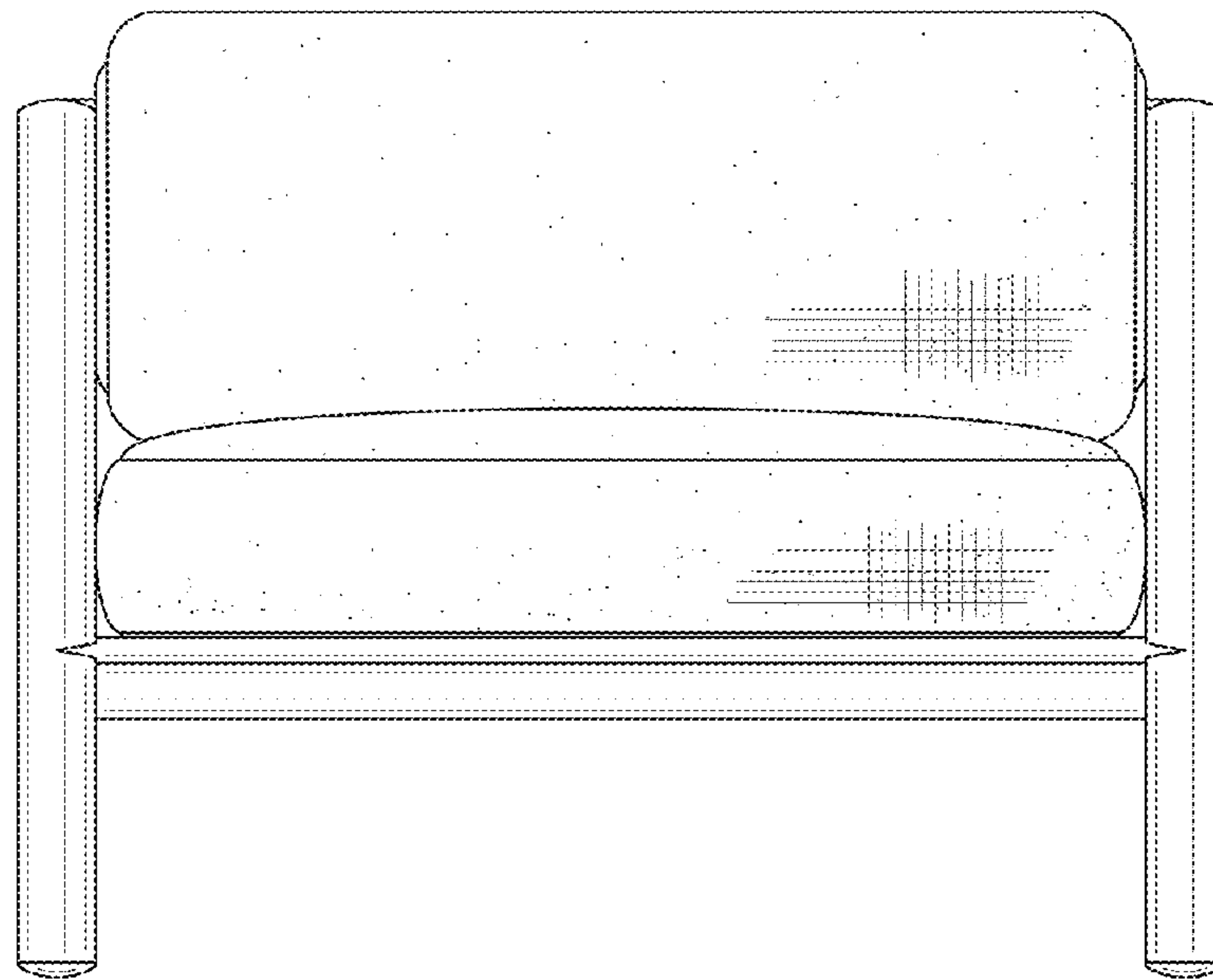

FIG. 2

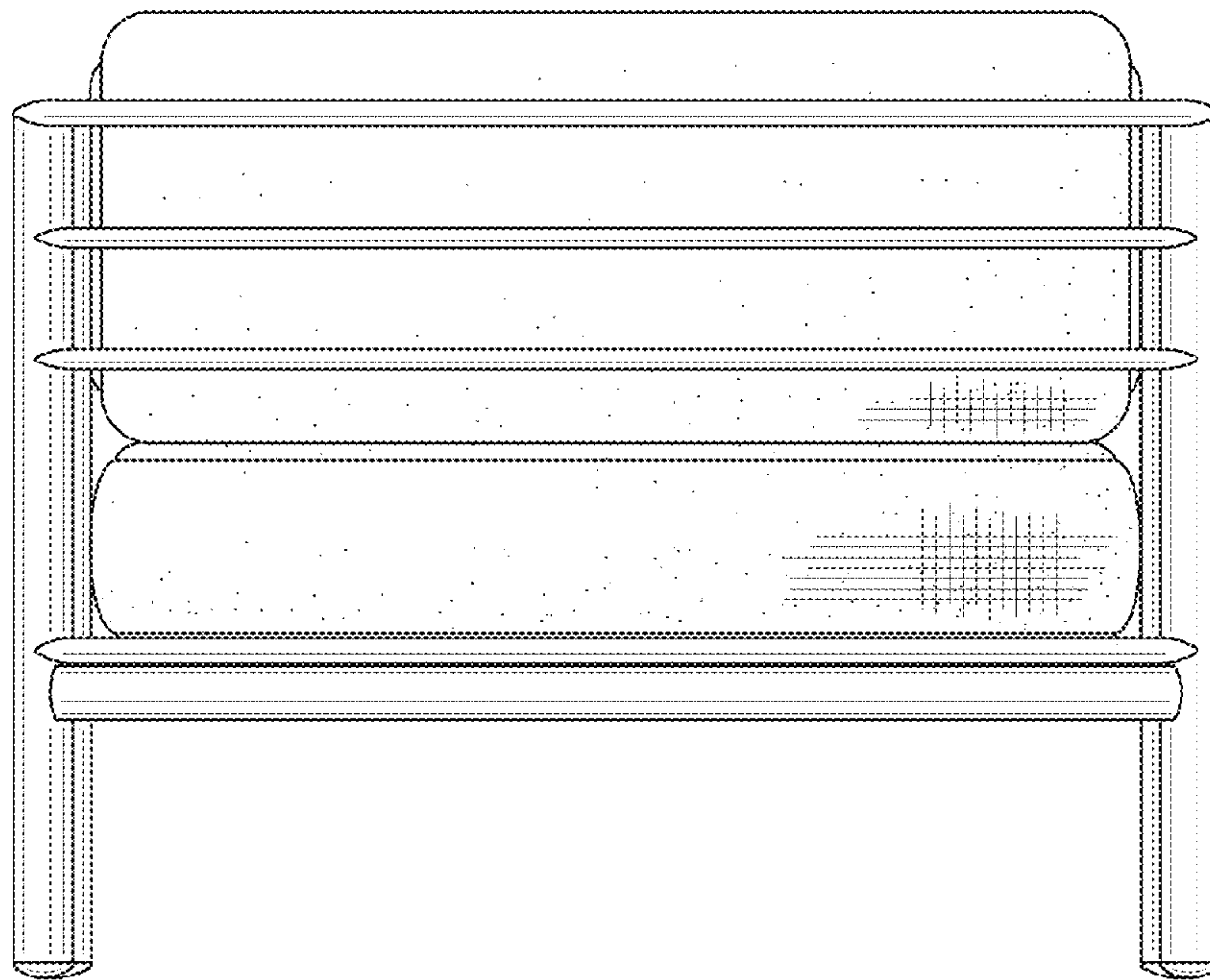

FIG. 3

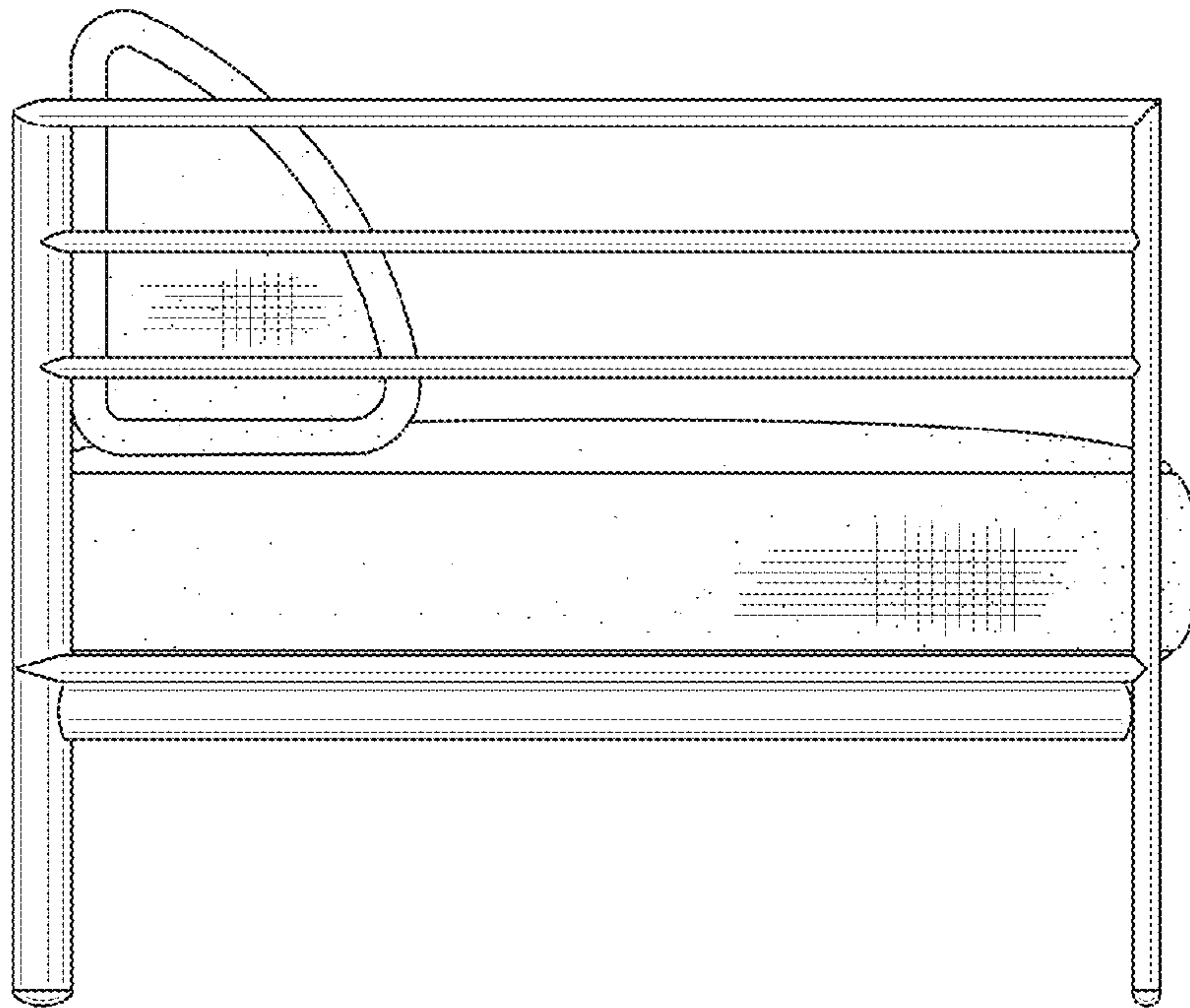

FIG. 4

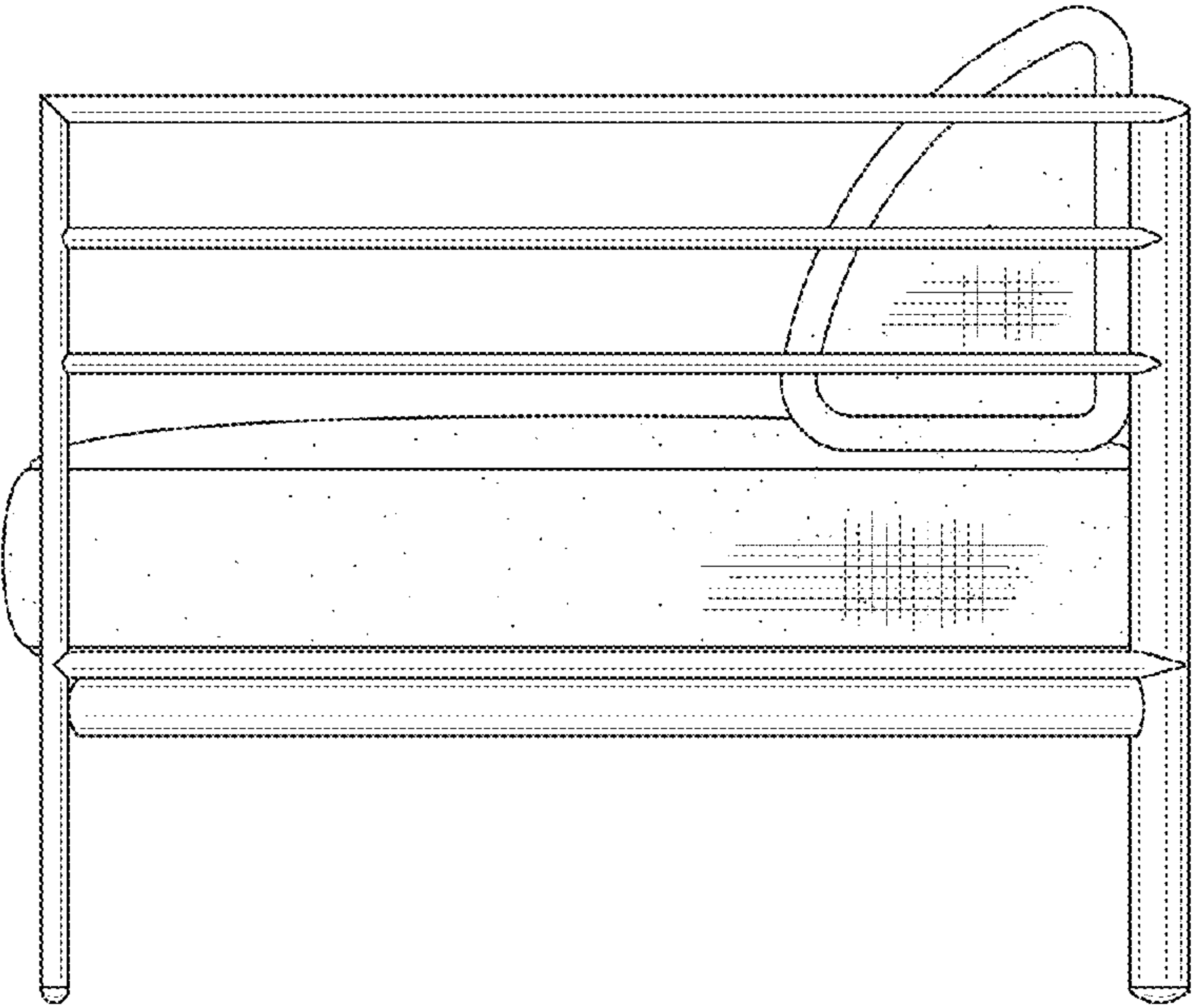

FIG. 5

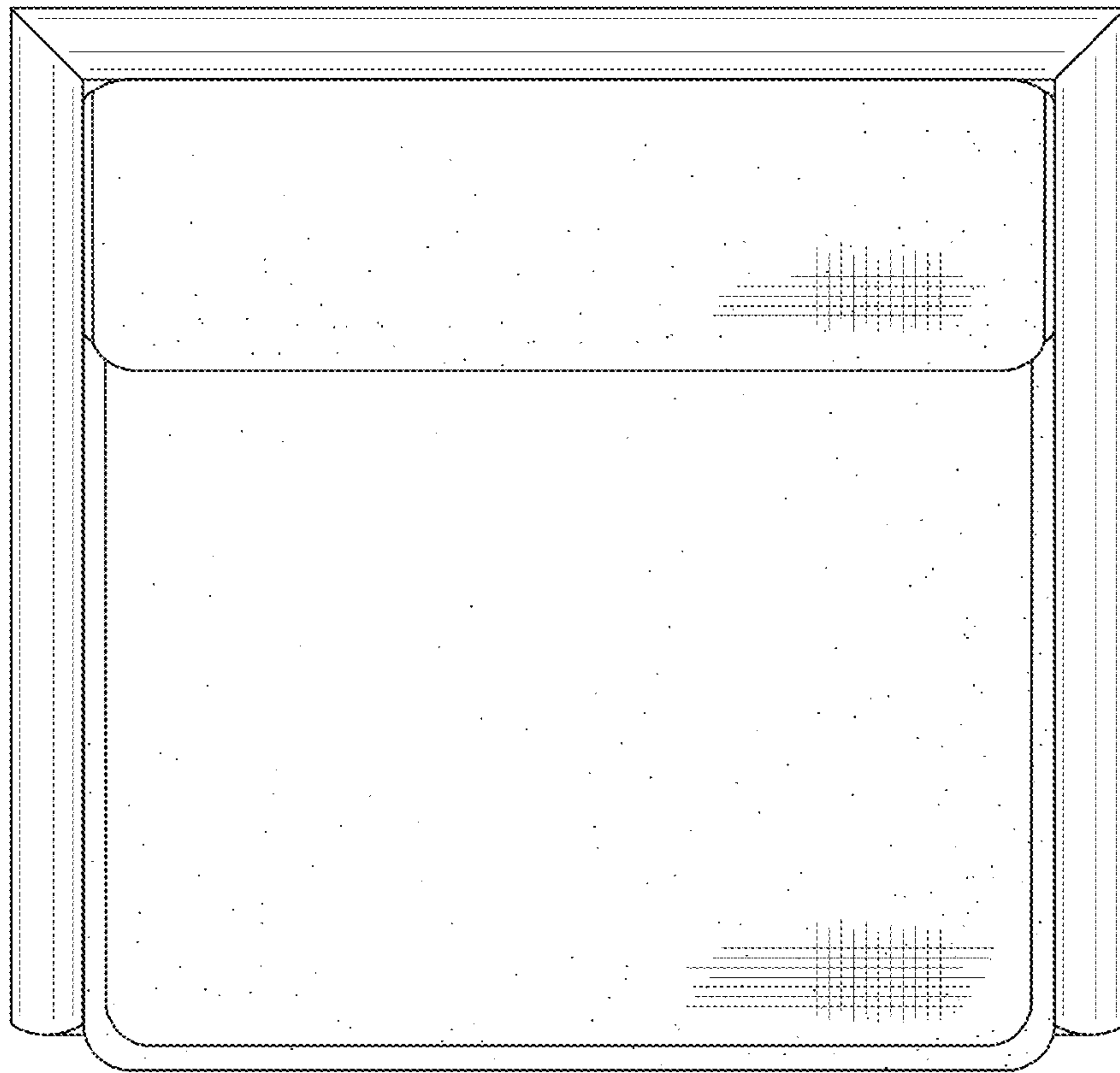

FIG. 6

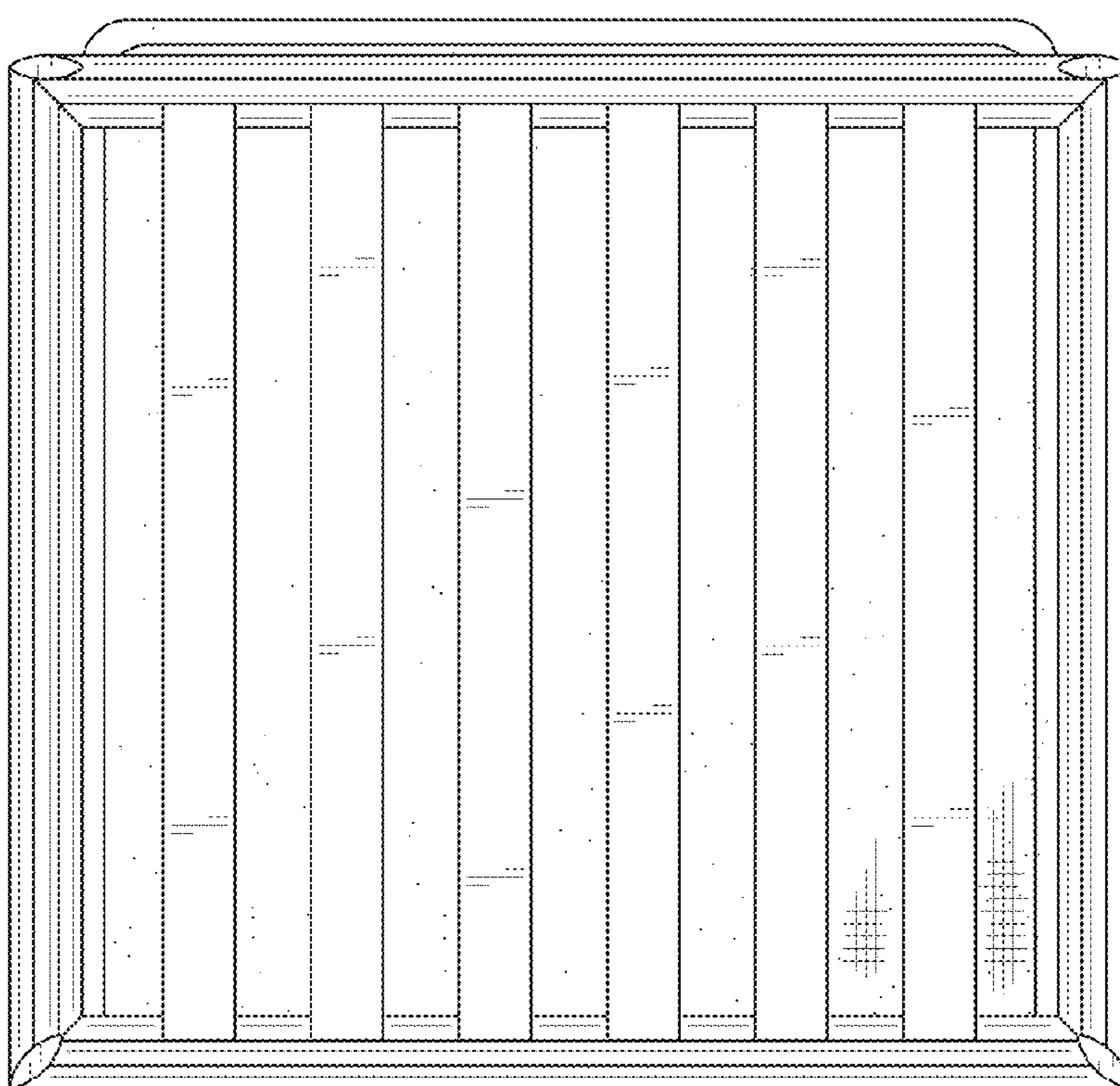

FIG. 7

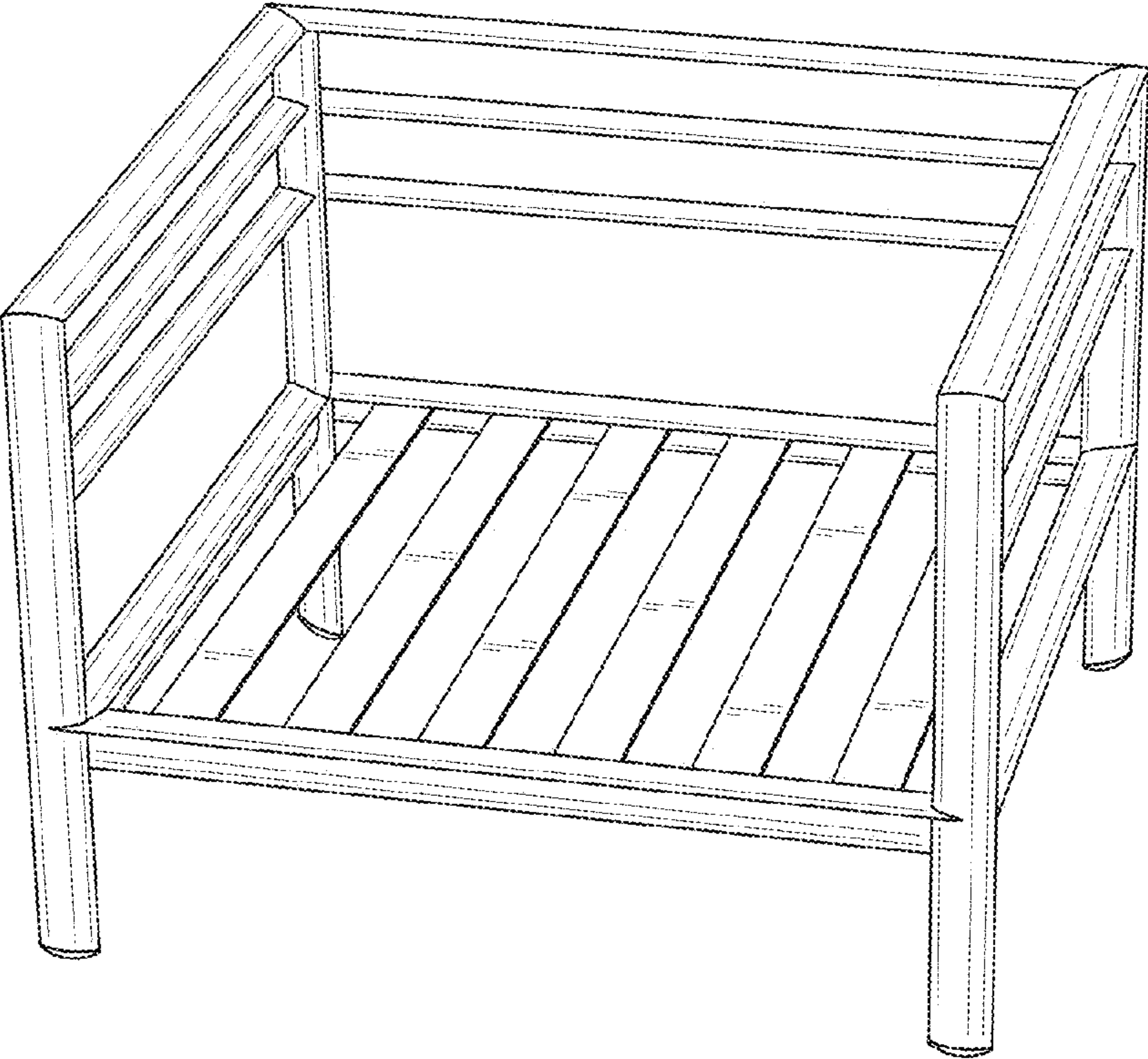

FIG. 8

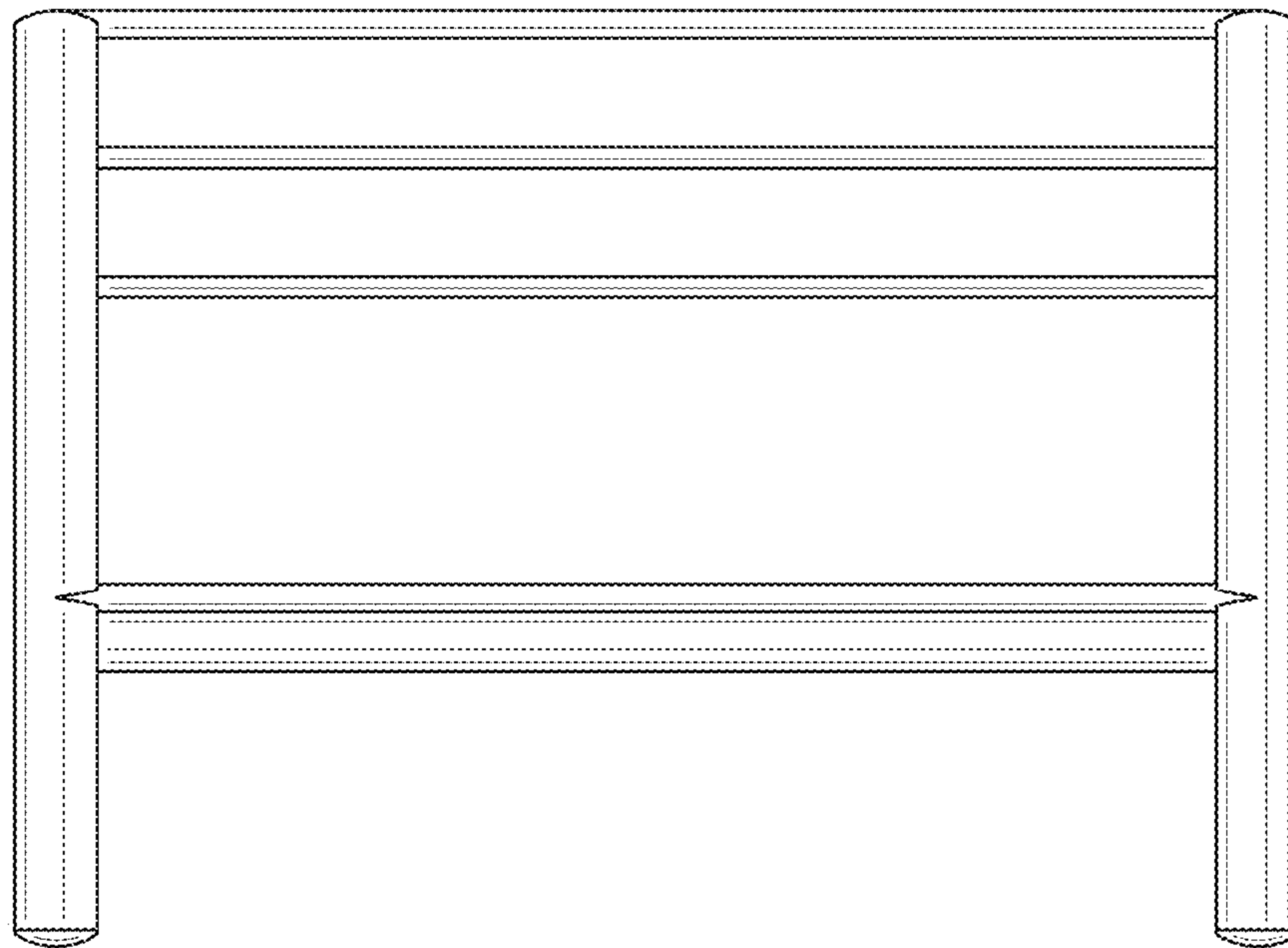

FIG. 9

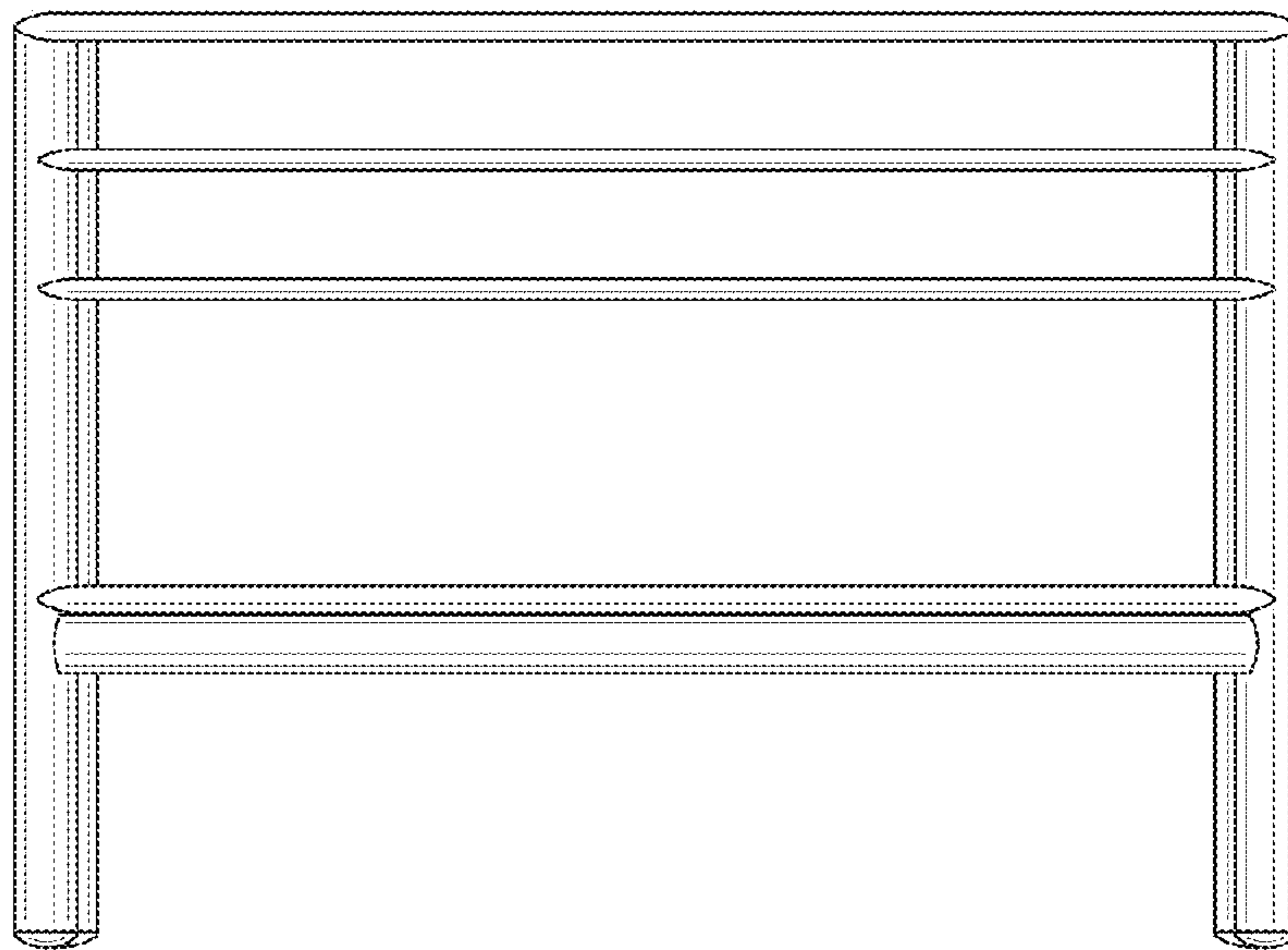

FIG. 10

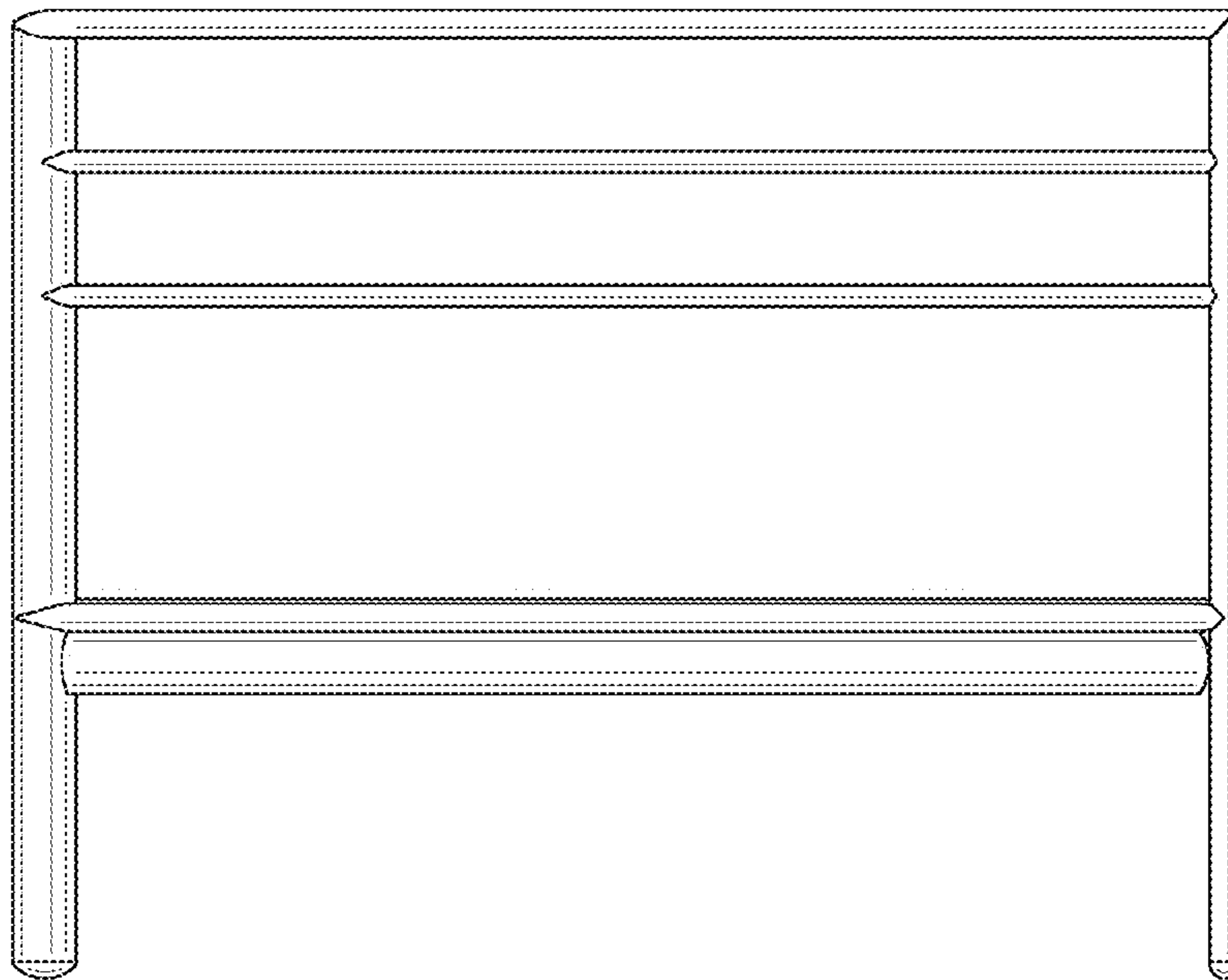

FIG. 11

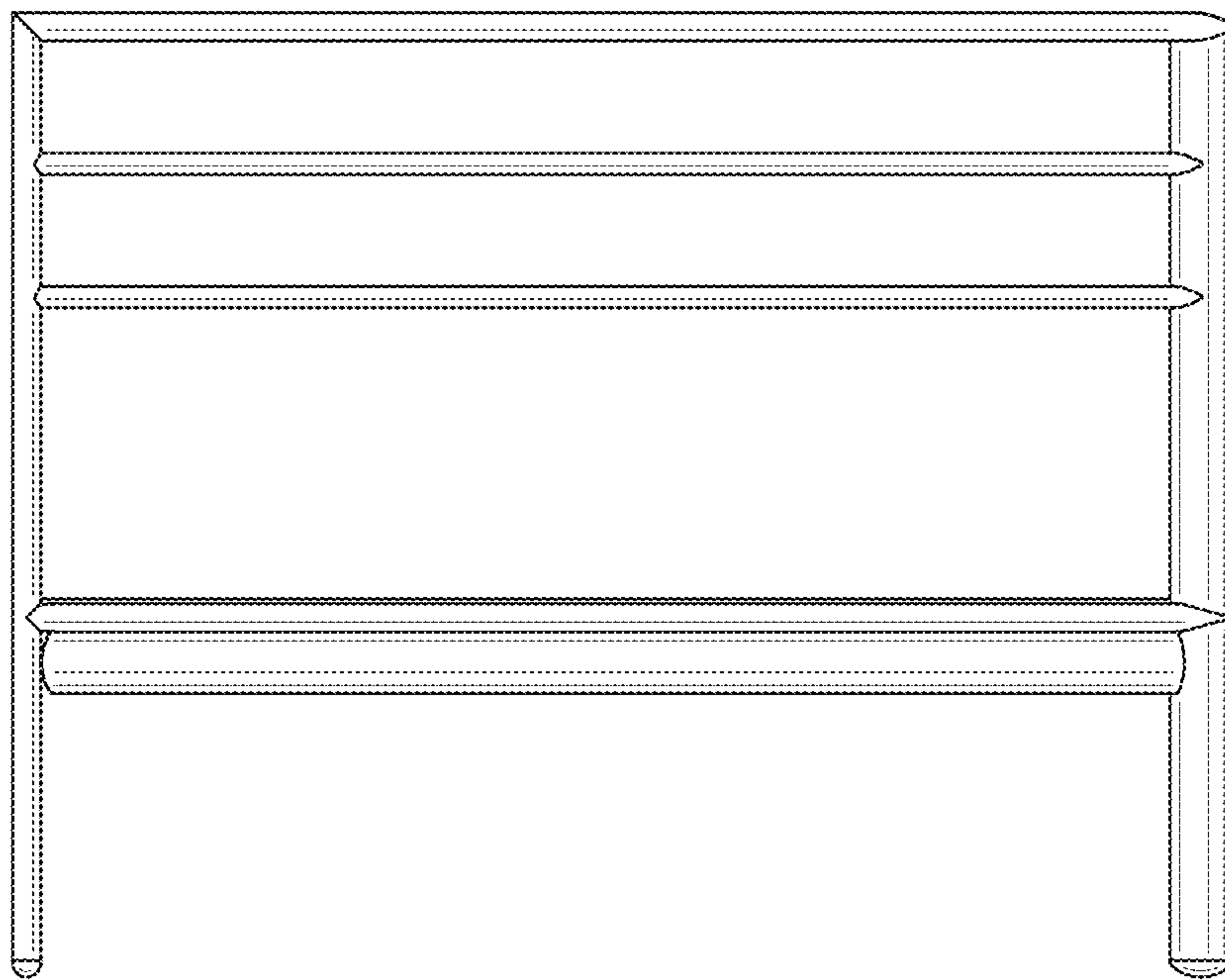

FIG. 12

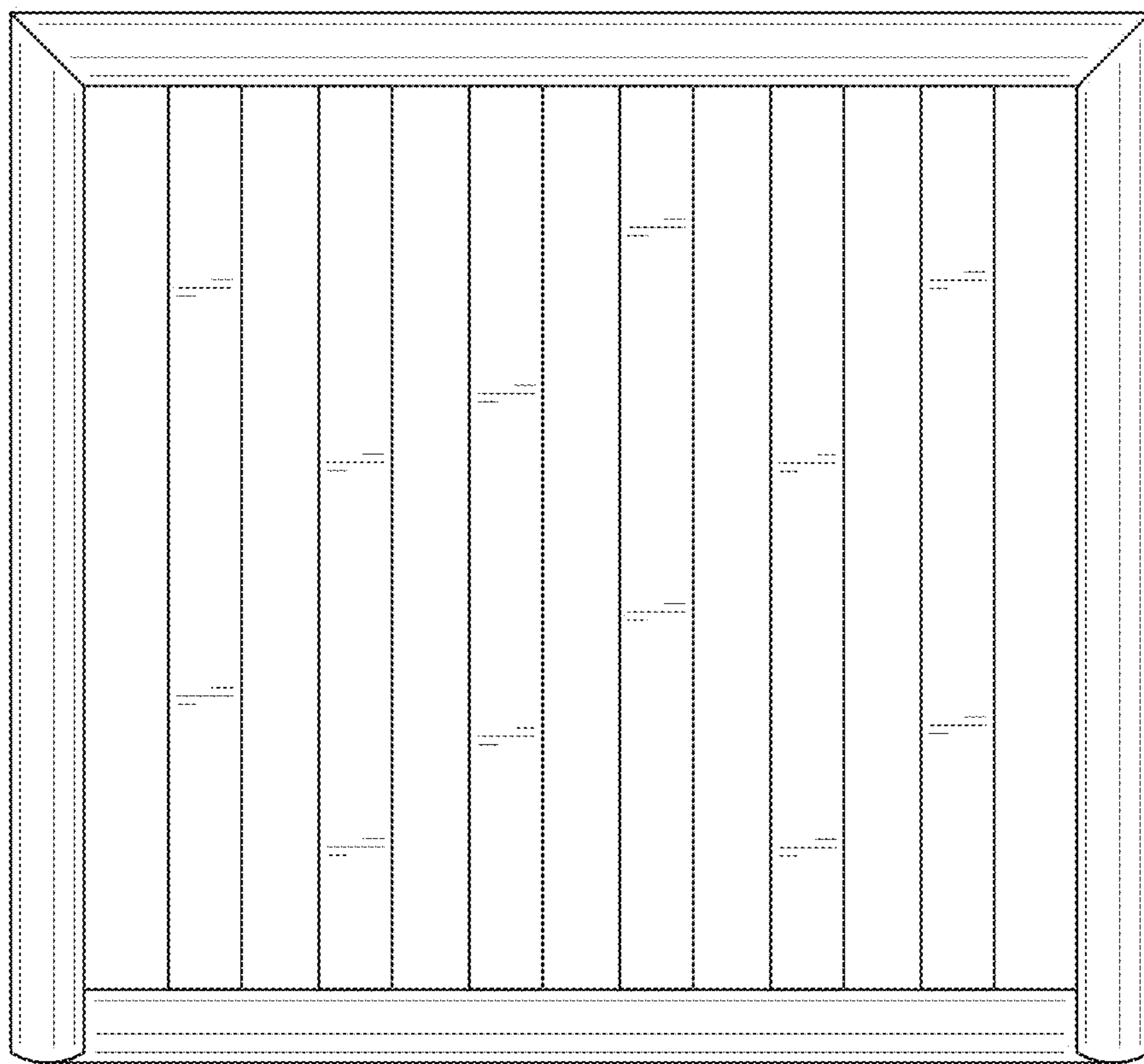

FIG. 13

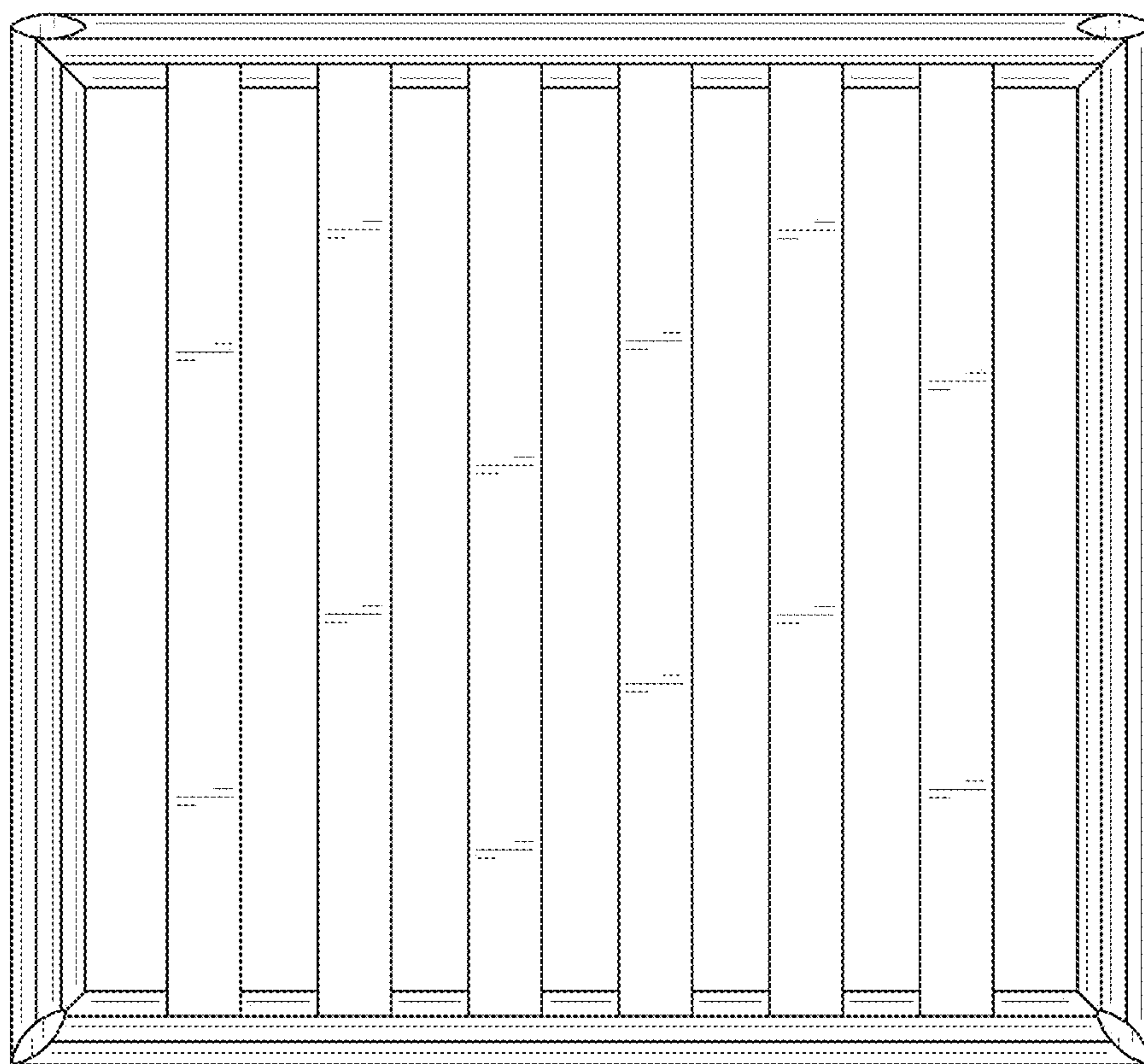

FIG. 14