



US00D698160S

(12) **United States Design Patent**
Spall

(10) **Patent No.:** **US D698,160 S**
(45) **Date of Patent:** **** Jan. 28, 2014**

(54) **PICTURE BOTTLE FRAME**

(76) Inventor: **Larry Spall**, Brownstown, IN (US)

(**) Term: **14 Years**

(21) Appl. No.: **29/430,612**

(22) Filed: **Aug. 28, 2012**

(51) **LOC (10) Cl.** **06-07**

(52) **U.S. Cl.**
USPC **D6/303**

(58) **Field of Classification Search**
USPC D6/300-314; D20/37; 215/41, 12.2;
D9/522, 552, 556
See application file for complete search history.

(56) **References Cited**

U.S. PATENT DOCUMENTS

3,825,141	A *	7/1974	Campagna	215/12.2
3,825,142	A *	7/1974	Campagna	215/12.2
D414,614	S *	10/1999	Pargman	D6/303
D416,945	S *	11/1999	Robinson	D20/37
2003/0106873	A1 *	6/2003	Grillo	215/41

* cited by examiner

Primary Examiner — Cathron C. Brooks

Assistant Examiner — Sydney R Buffalow

(74) *Attorney, Agent, or Firm* — QuickPatents; Kevin Prince

(57) **CLAIM**

I claim the ornamental design for a picture bottle frame, as shown and described.

DESCRIPTION

FIG. 1 is a perspective view of a picture bottle frame, showing a first embodiment of my new design;
 FIG. 2 is a front elevational view of FIG. 1;
 FIG. 3 is a rear elevational view of FIG. 1;
 FIG. 4 is a left-side elevational view of FIG. 1;
 FIG. 5 is a right-side elevational view of FIG. 1;
 FIG. 6 is a top plan view of FIG. 1;
 FIG. 7 is a bottom plan view of FIG. 1;
 FIG. 8 is a perspective view of a second embodiment thereof;
 FIG. 9 is a front elevational view of FIG. 8;
 FIG. 10 is a rear elevational view of FIG. 8;
 FIG. 11 is a top plan view of FIG. 8; and,
 FIG. 12 is a bottom plan view of FIG. 8.
 The broken lines showing photographs in FIGS. 1, 4, 5, and 8-10 depict environmental matter and form no part of the claimed design. It is understood that the left and right side elevational views of the second embodiment are identical to those of the first embodiment.

1 Claim, 11 Drawing Sheets

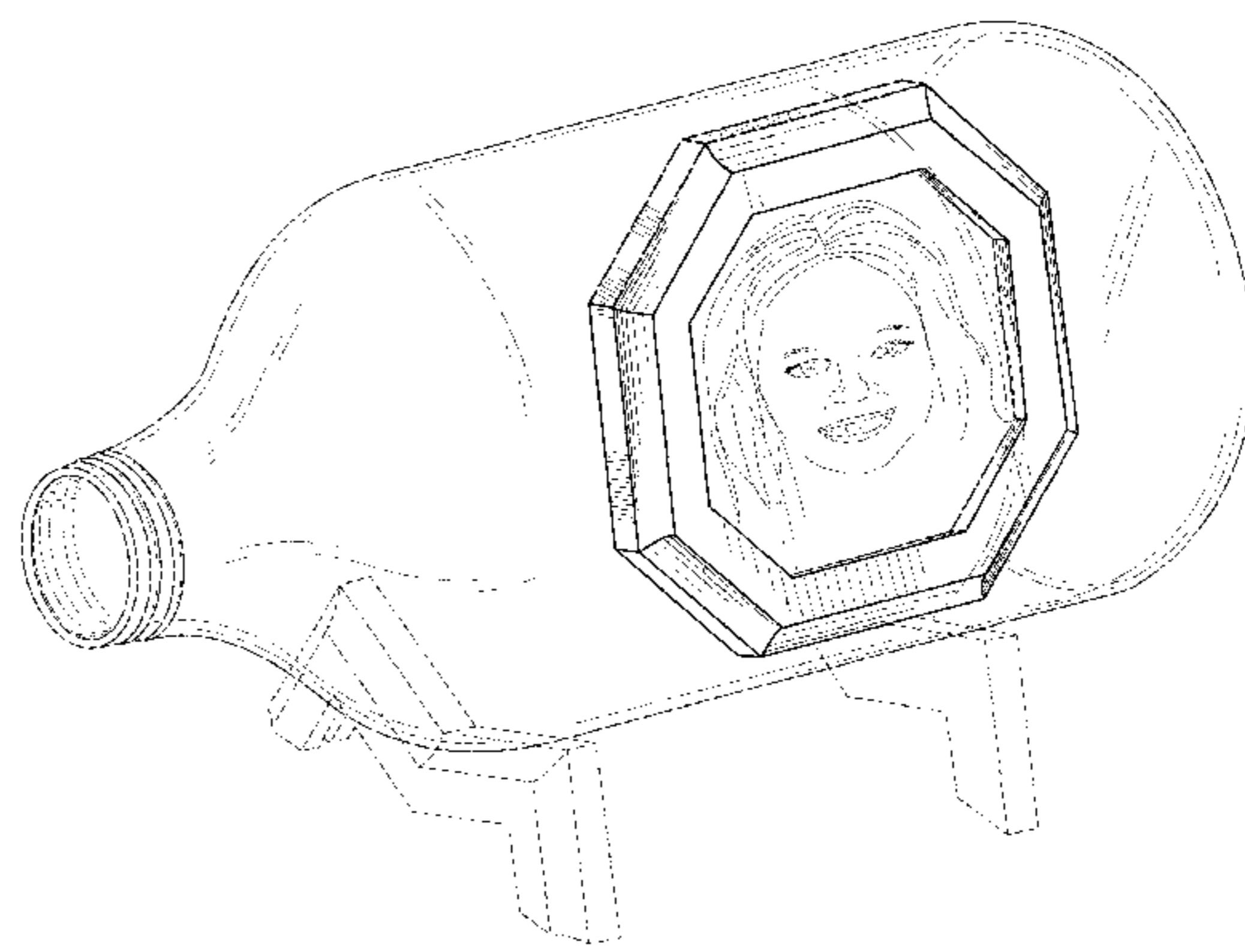
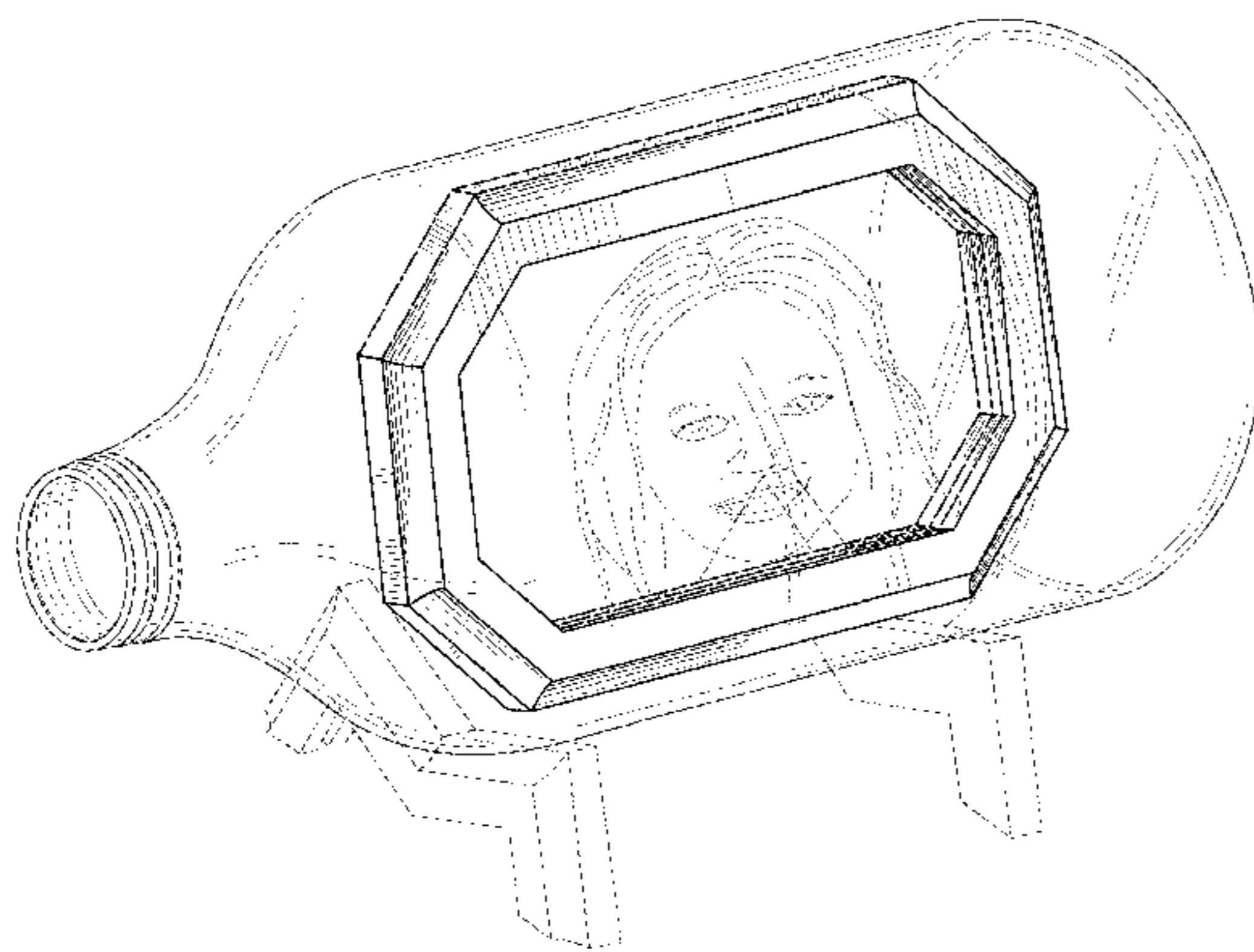

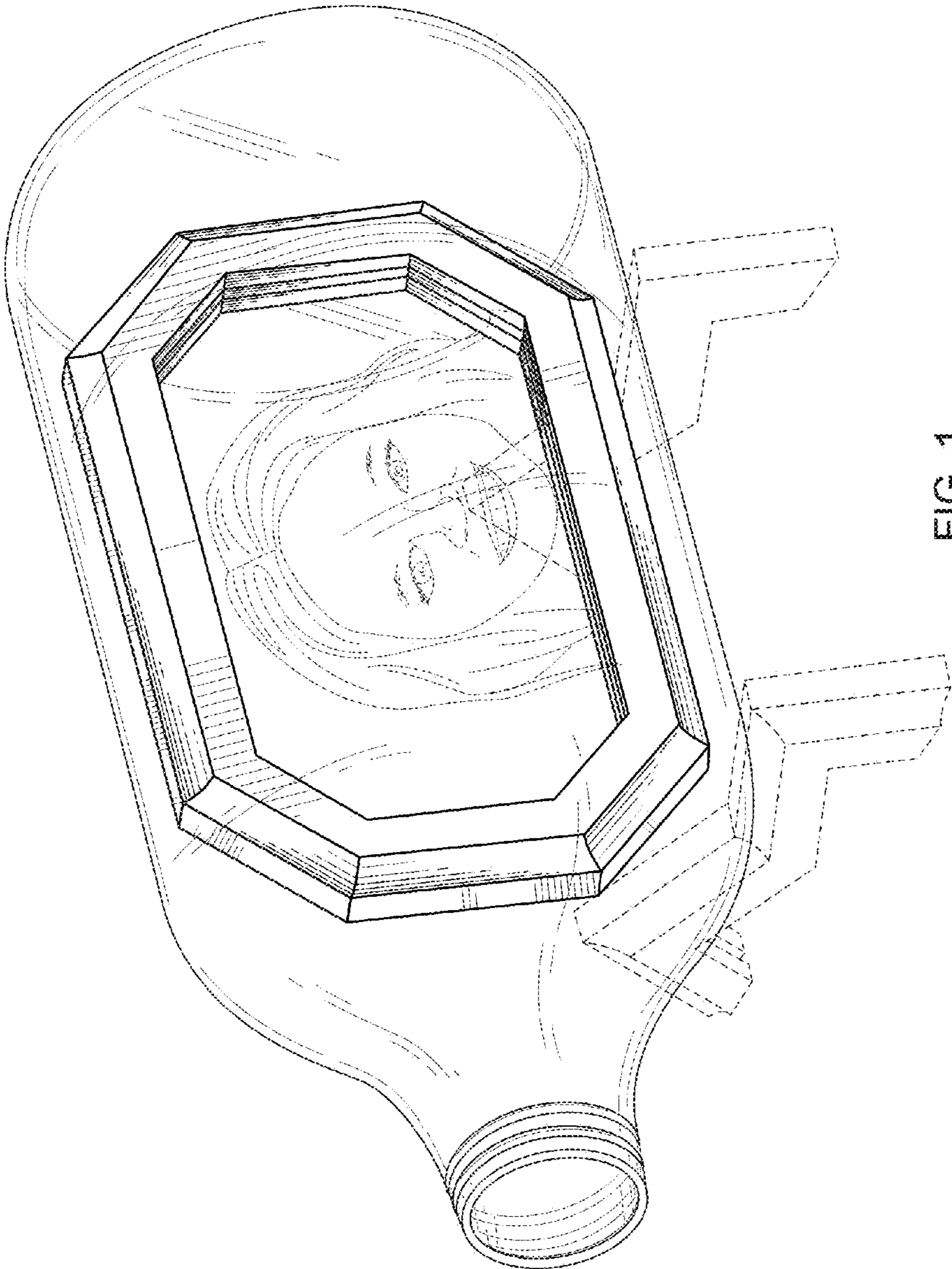

FIG. 1

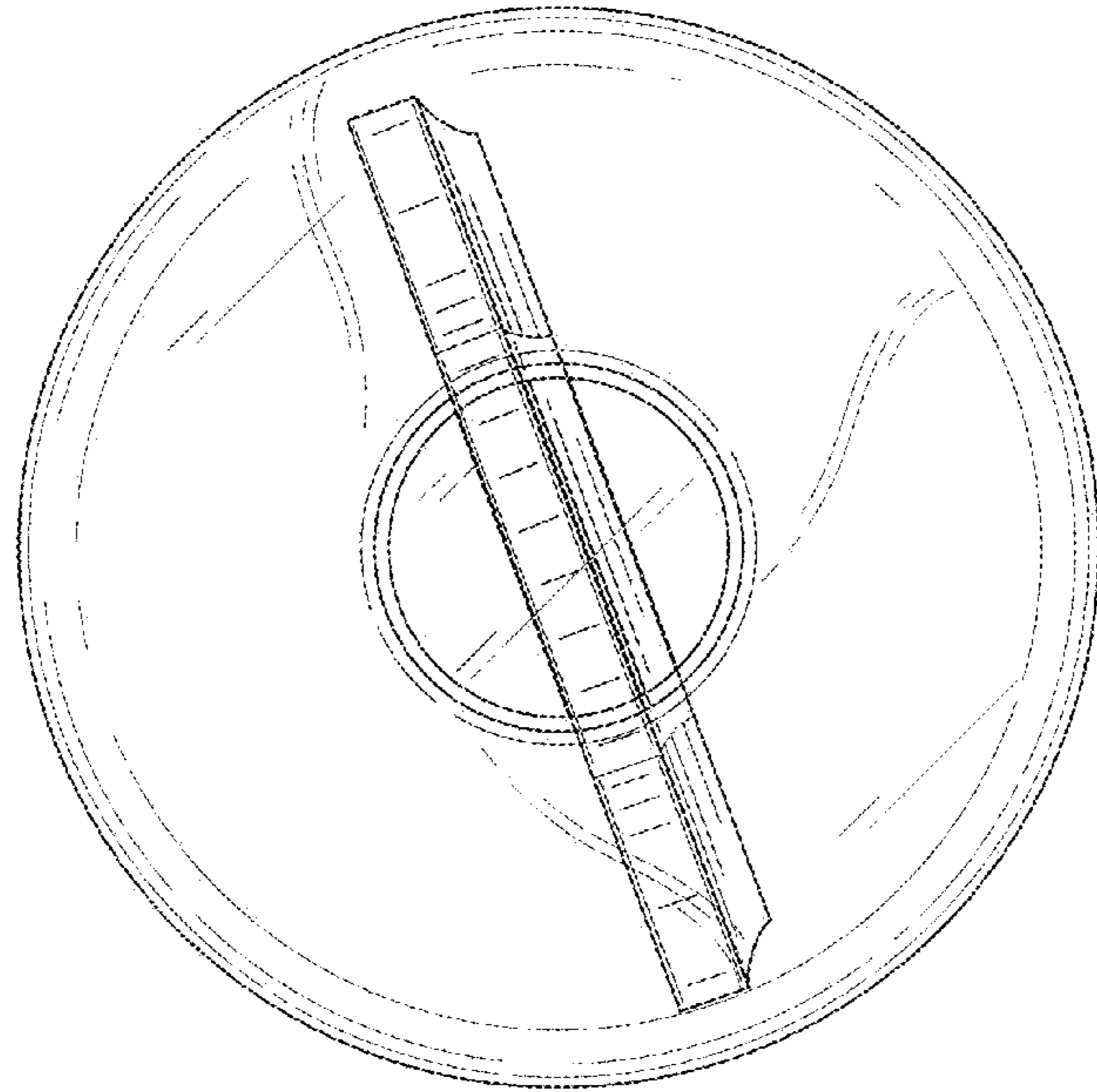

FIG. 2

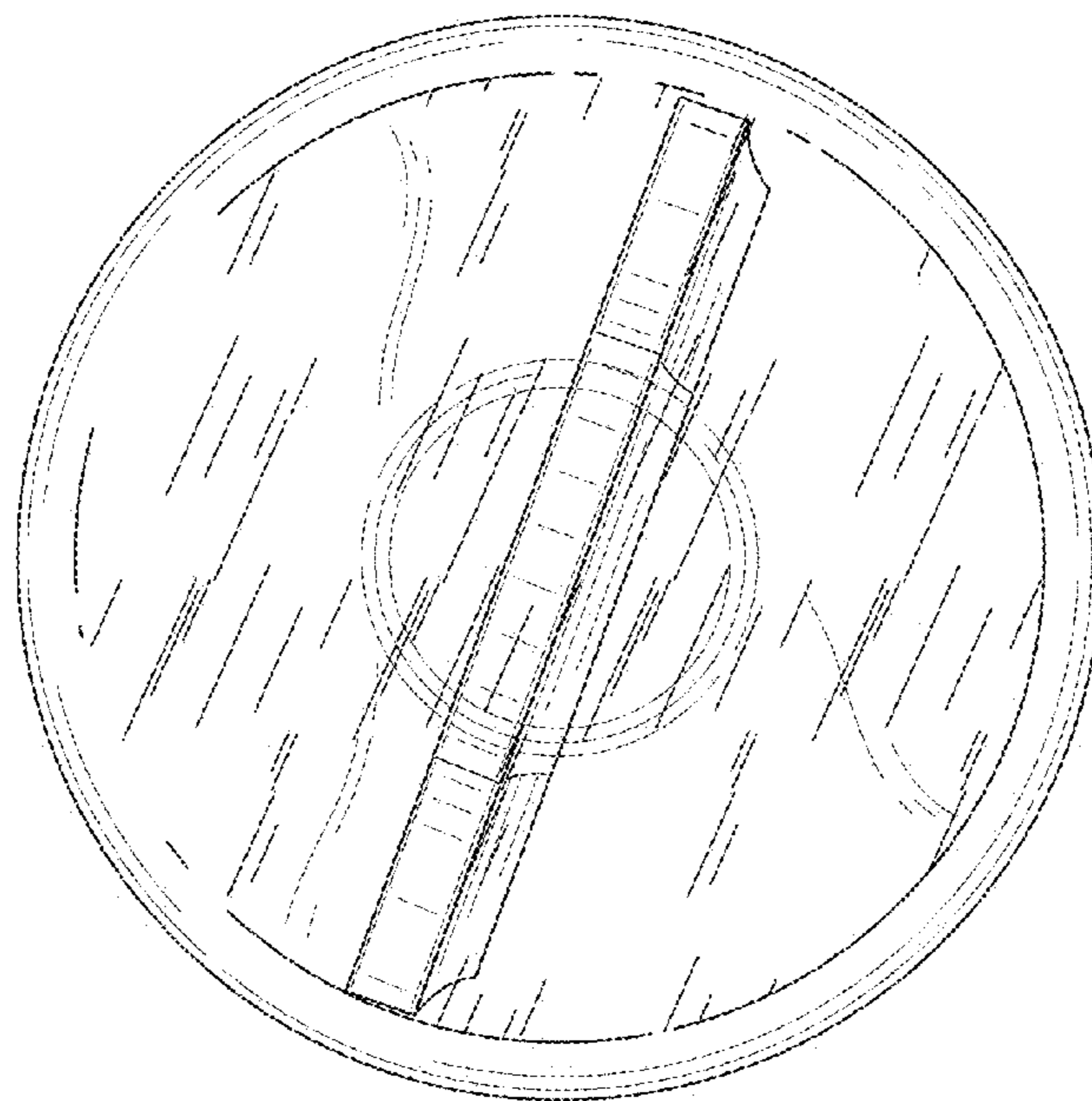

FIG. 3

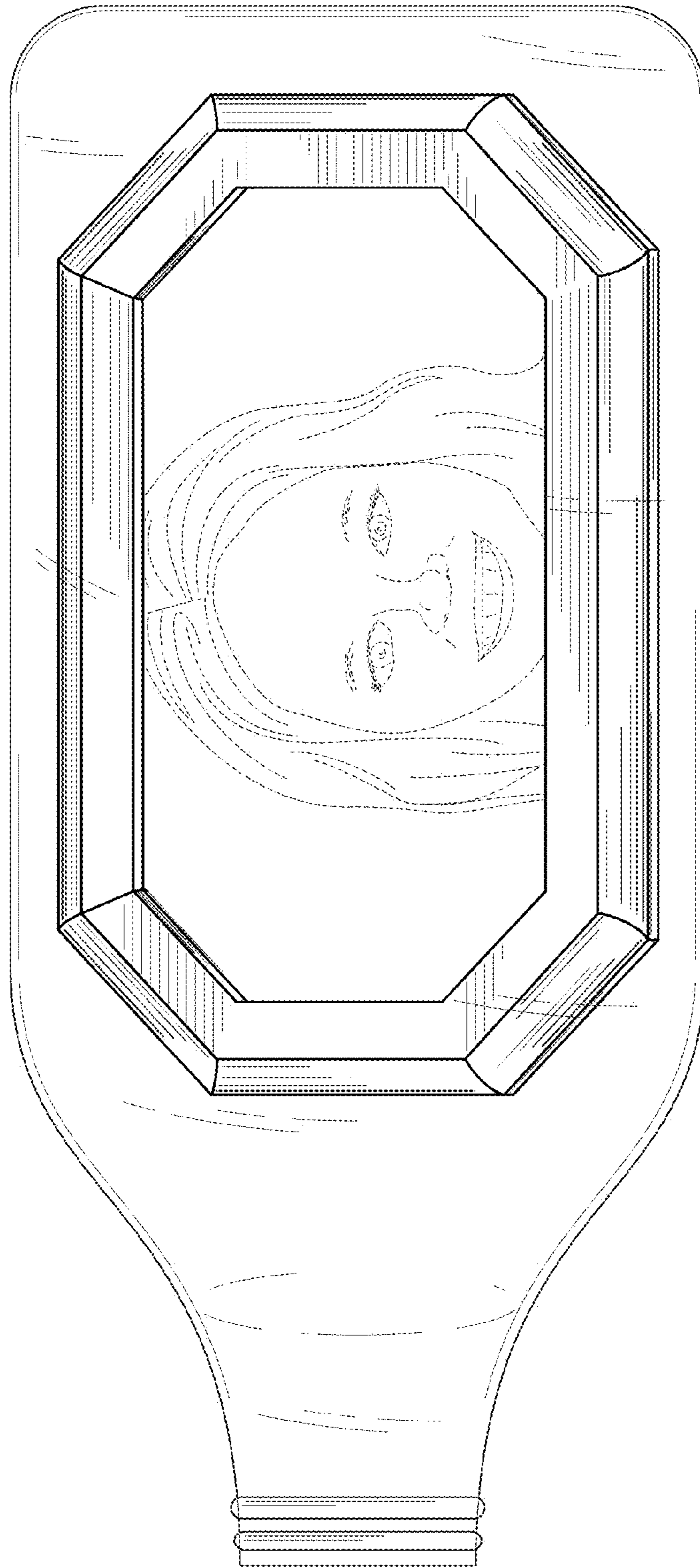

FIG. 4

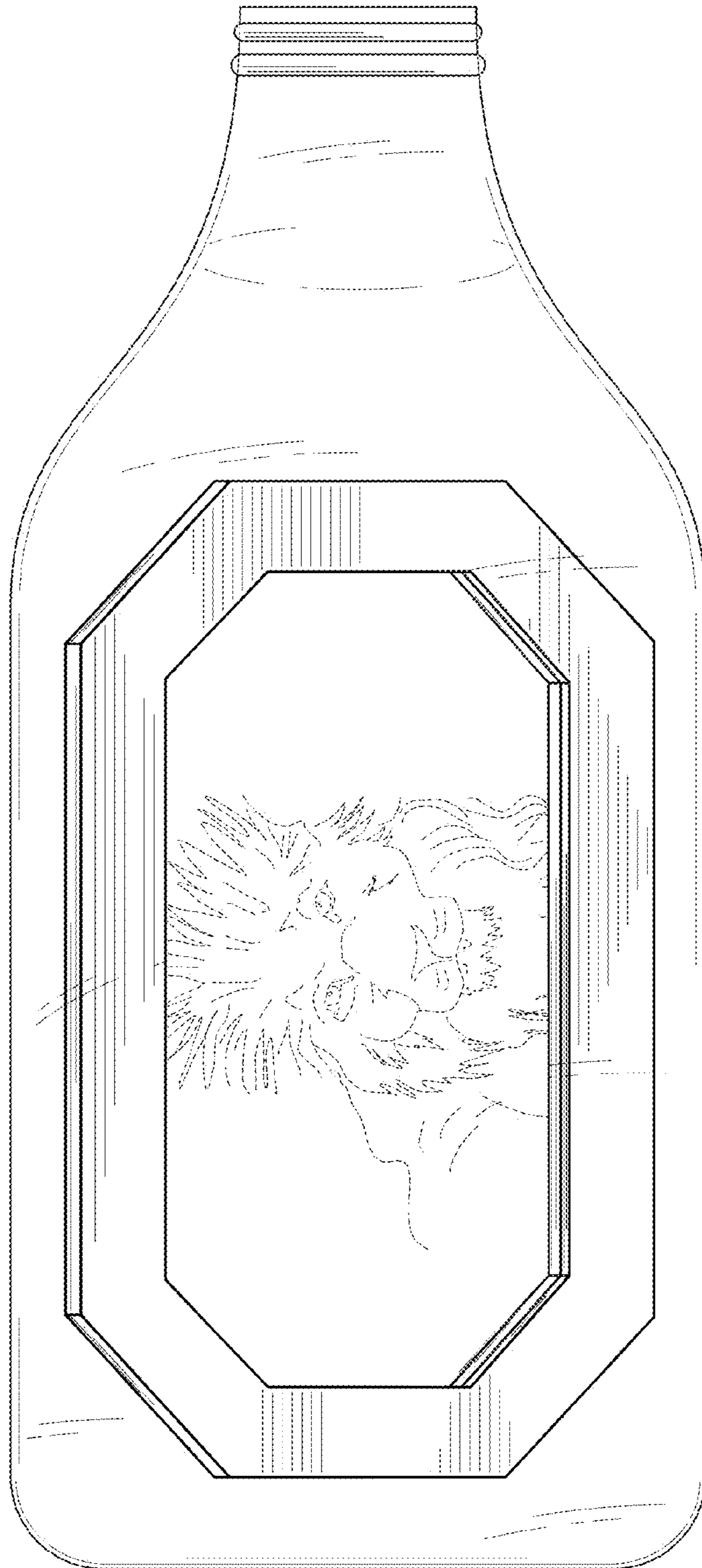

FIG. 5

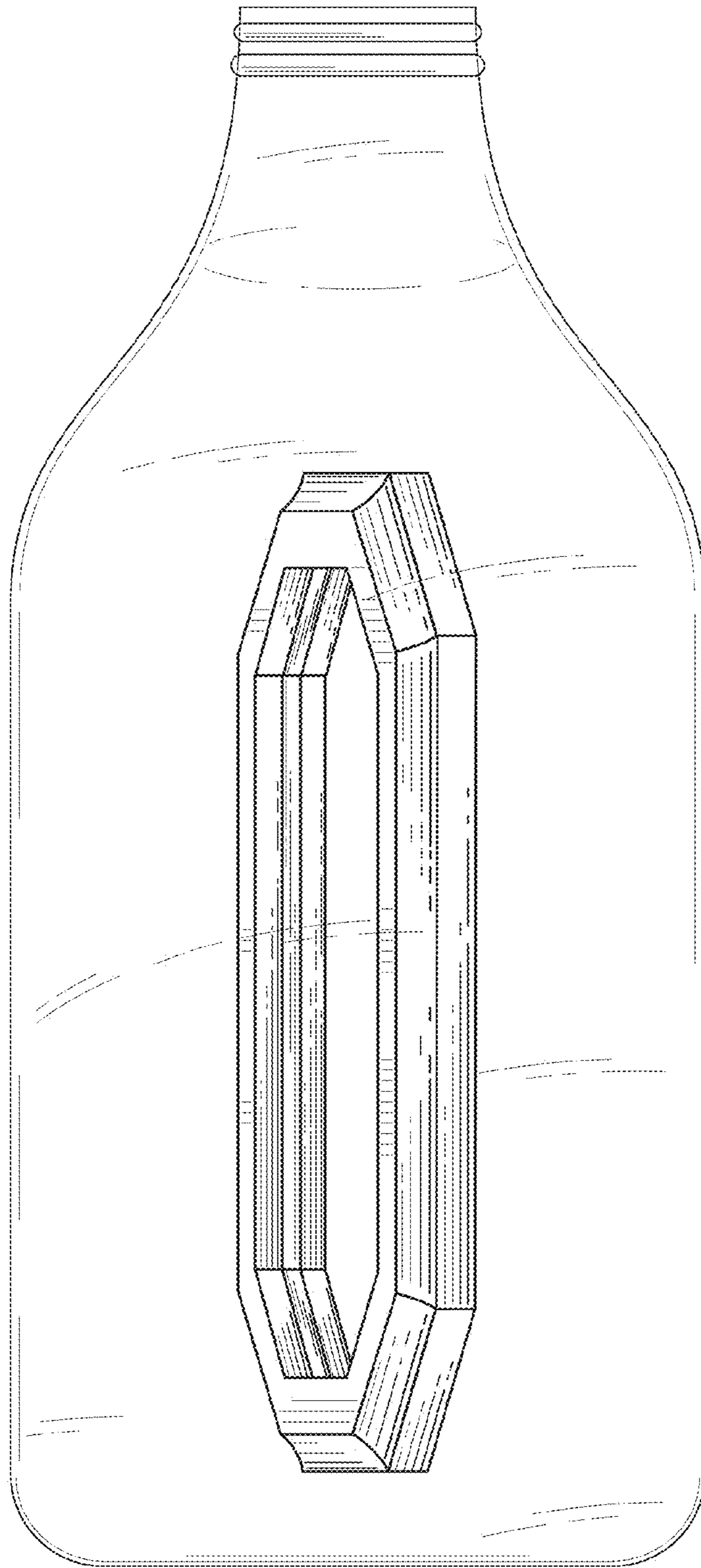

FIG. 6

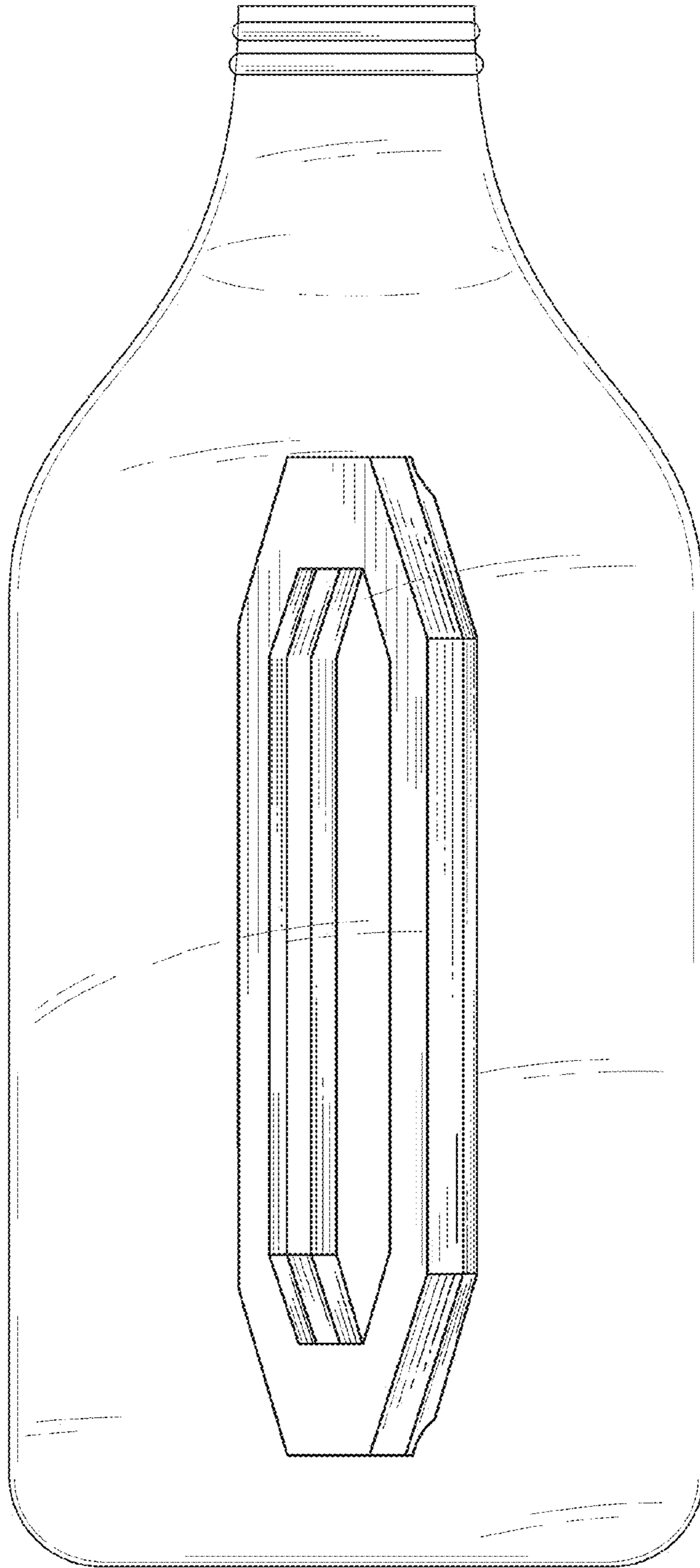

FIG. 7

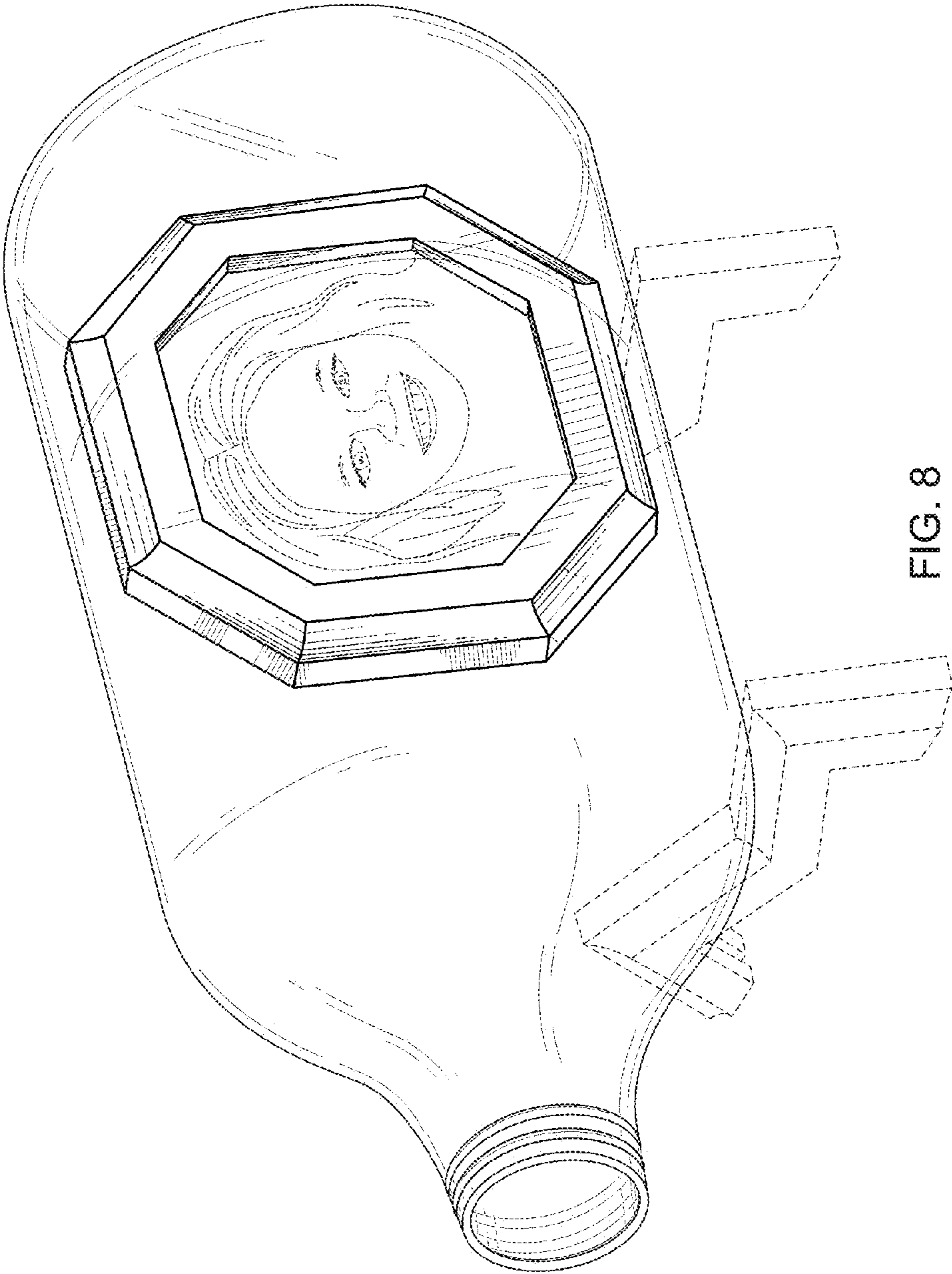

FIG. 8

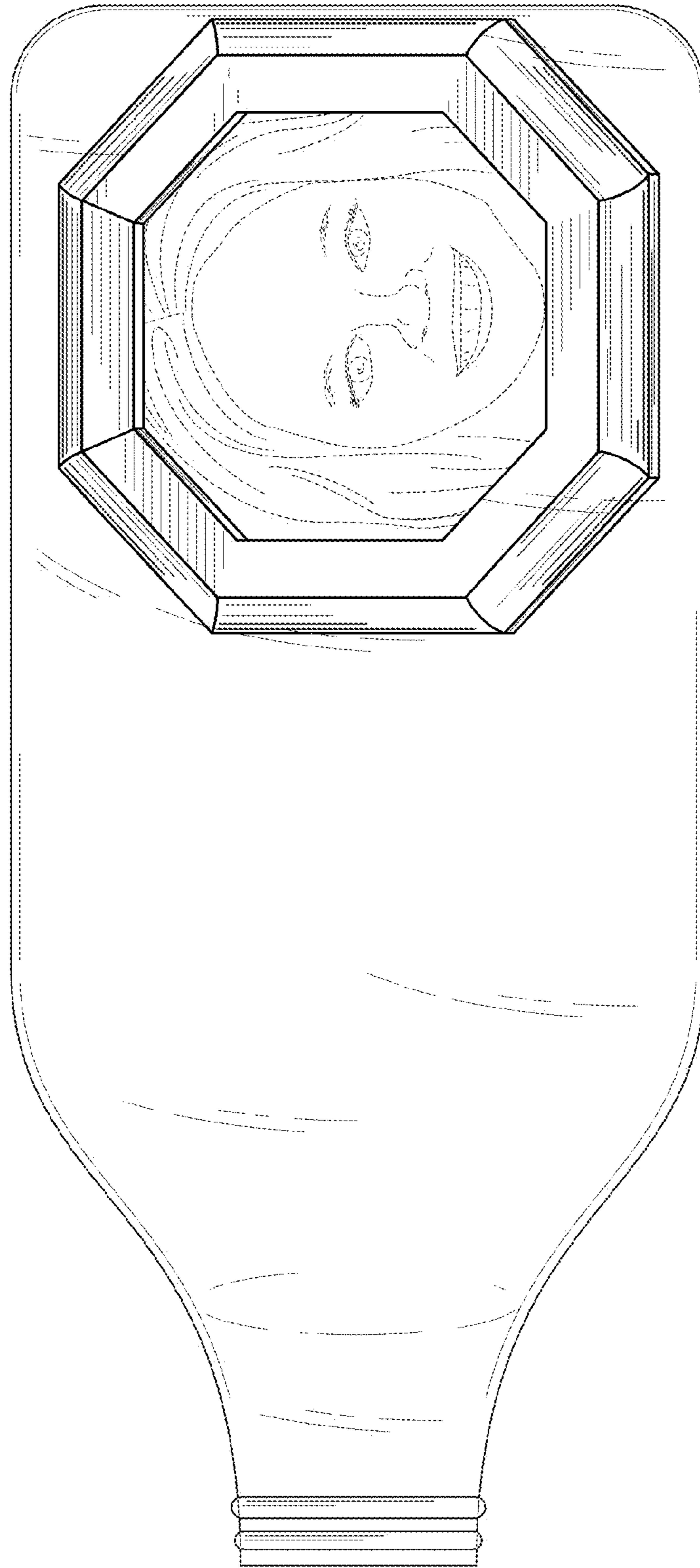

FIG. 9

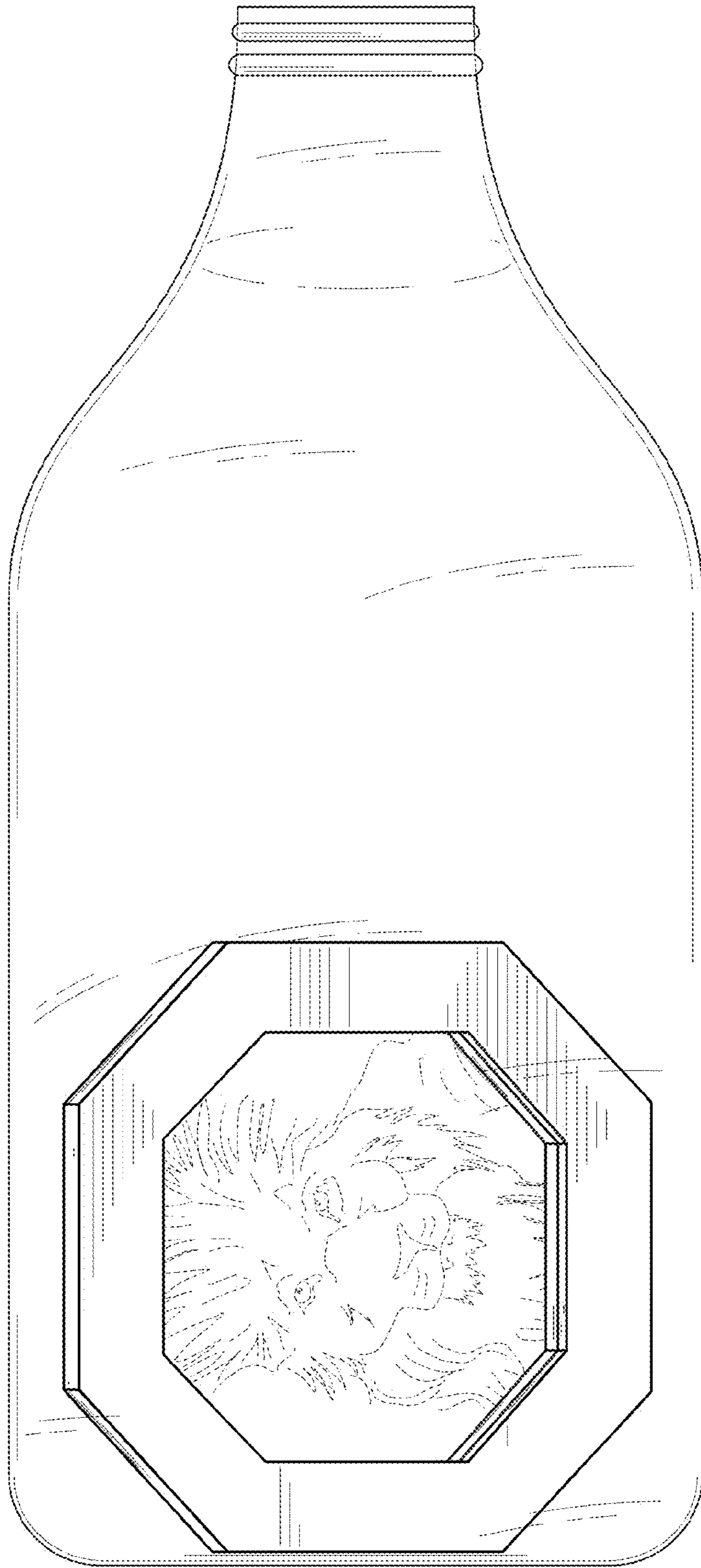

FIG. 10

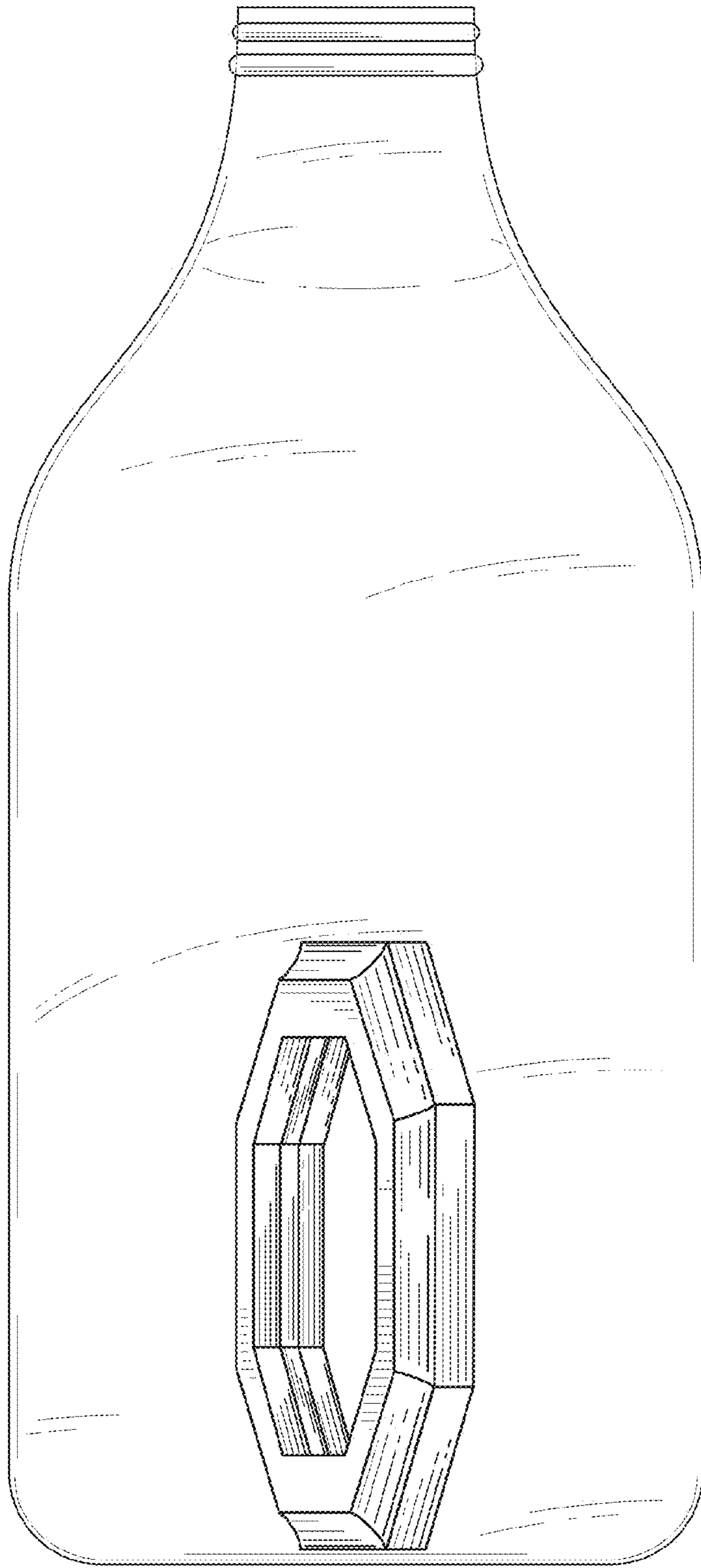

FIG. 11

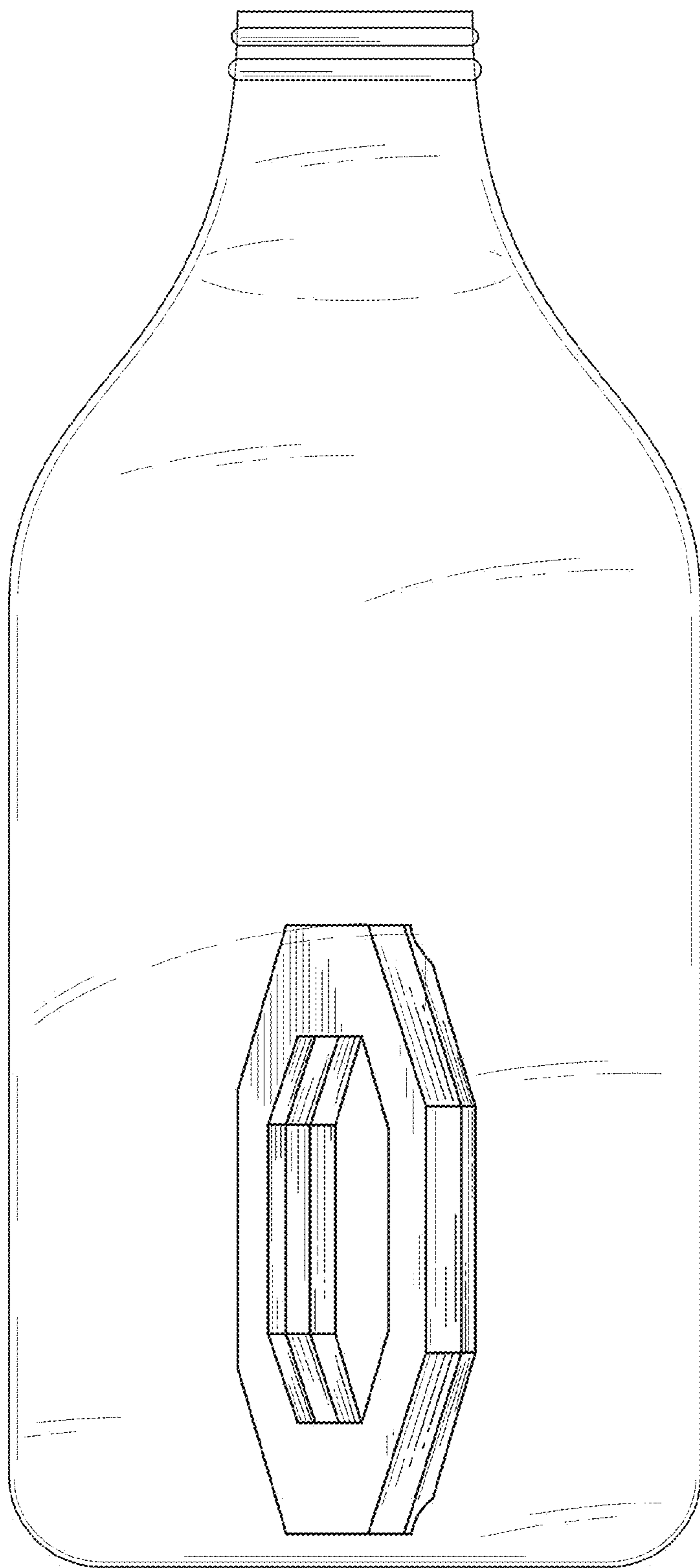

FIG. 12