



US00D698130S

(12) **United States Design Patent**  
**Worden, IV et al.**

(10) **Patent No.:** **US D698,130 S**  
(45) **Date of Patent:** **\*\* Jan. 28, 2014**

(54) **CHILD'S BIB**

(71) Applicants: **Morris Elijah Worden, IV**, New York, NY (US); **Brook Kennedy**, Blacksburg, VA (US); **Nicholas Oxley**, Brooklyn, NY (US); **Stian Tesdal**, New York, NY (US)

(72) Inventors: **Morris Elijah Worden, IV**, New York, NY (US); **Brook Kennedy**, Blacksburg, VA (US); **Nicholas Oxley**, Brooklyn, NY (US); **Stian Tesdal**, New York, NY (US)

(73) Assignee: **Helen of Troy Limited**, St. Michael (BB)

(\*\*) Term: **14 Years**

(21) Appl. No.: **29/443,916**

(22) Filed: **Jan. 24, 2013**

(51) **LOC (10) Cl.** ..... **02-02**

(52) **U.S. Cl.**  
USPC ..... **D2/864**

(58) **Field of Classification Search**  
USPC ..... D2/860, 861, 864; 2/46, 48-51  
See application file for complete search history.

(56) **References Cited**

**U.S. PATENT DOCUMENTS**

2,446,689	A *	8/1948	Brose et al.	2/49.5
D152,879	S *	3/1949	Grassi	D2/864
2,760,200	A *	8/1956	Shamyer, Jr.	2/49.2
3,407,407	A *	10/1968	Hollander et al.	2/49.2
D216,291	S *	12/1969	Korshak	D2/864
D382,987	S *	9/1997	Johnson, Jr.	D2/861
D383,891	S *	9/1997	Hill	D2/864
6,105,165	A *	8/2000	Johnson et al.	2/49.2
6,481,016	B1 *	11/2002	Rees	2/49.1

7,076,807	B2 *	7/2006	Bergkvist	2/49.1
7,143,448	B1 *	12/2006	Gottehrer	2/49.2
D684,752	S *	6/2013	Nguyen	D2/864
D690,909	S *	10/2013	Albers	D2/864

\* cited by examiner

*Primary Examiner* — Rashida Johnson

(57) **CLAIM**

The ornamental design for a child's bib, as shown, and described.

**DESCRIPTION**

FIG. 1 is a front view of the child's bib in the unfolded position;  
 FIG. 2 is a rear view of the child's bib in the unfolded position;  
 FIG. 3 is a side view of the child's bib in the unfolded position;  
 FIG. 4 is a top view of the child's bib in the unfolded position;  
 FIG. 5 is a bottom view of the child's bib in the unfolded position;  
 FIG. 6 is a perspective view of the child's bib in the unfolded position;  
 FIG. 7 is a perspective view of the child's bib in the unfolded position with fastener attached;  
 FIG. 8 is a perspective view of the child's bib in the unfolded position in a use environment;  
 FIG. 9 is a front view of the child's bib in the folded position;  
 FIG. 10 is a rear view of the child's bib in the folded position;  
 FIG. 11 is a side view of the child's bib in the folded position;  
 FIG. 12 is a top view of the child's bib in the folded position;  
 FIG. 13 is a bottom view of the child's bib in the folded position; and,  
 FIG. 14 is a perspective view of the child's bib in the folded position.  
 The broken lines are for illustrative purposes only and form no part of the claimed design.

**1 Claim, 14 Drawing Sheets**

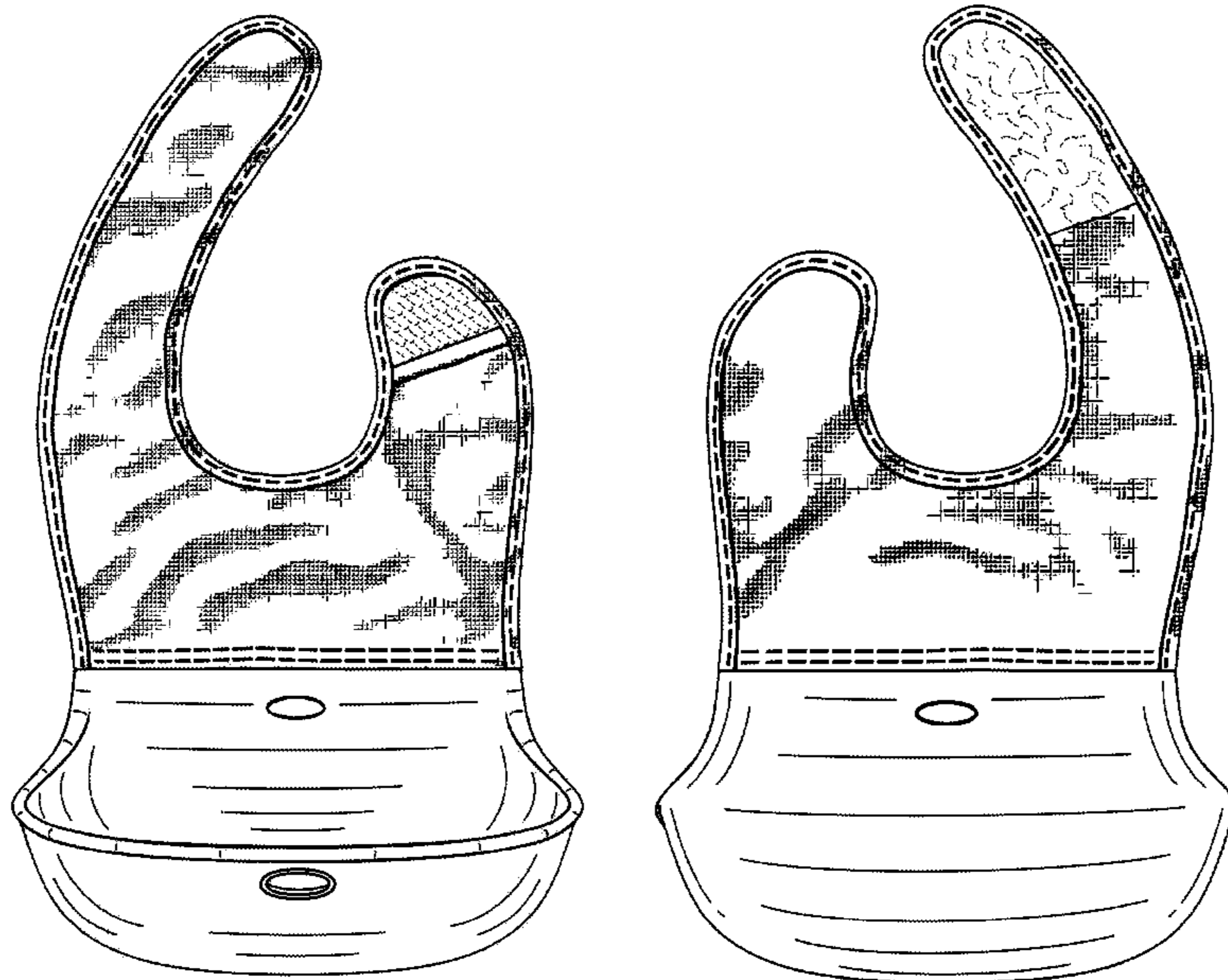

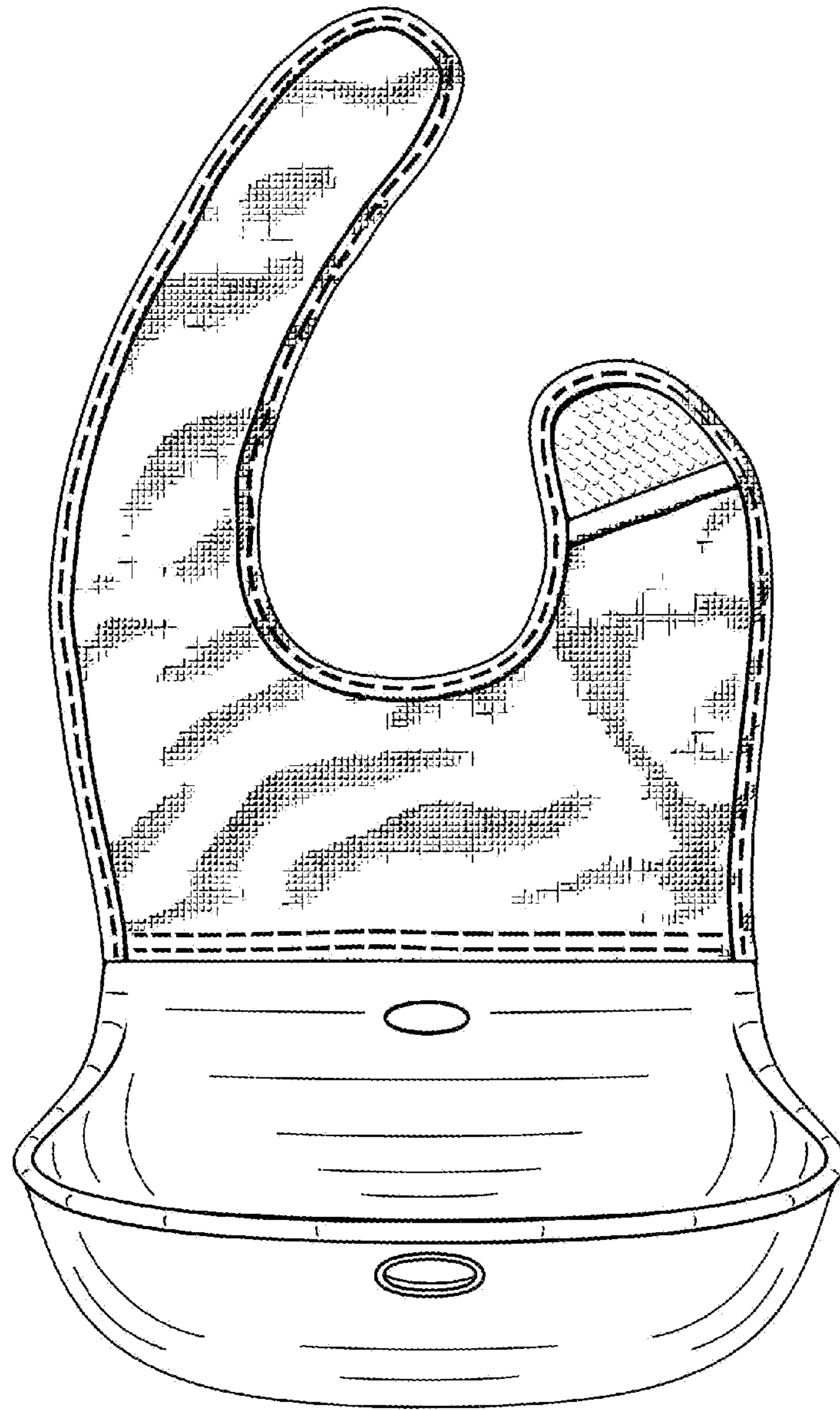

Figure 1

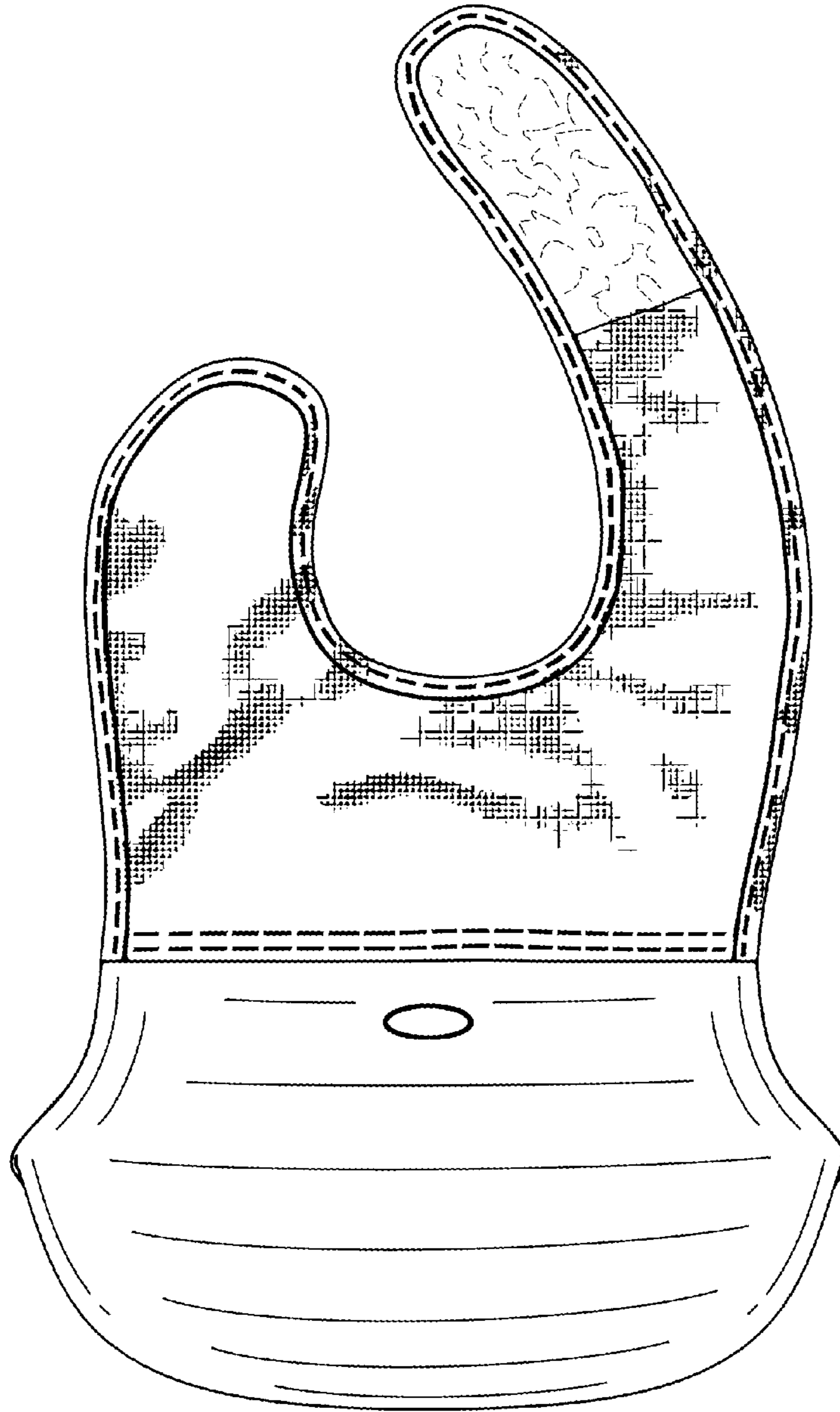

Figure 2

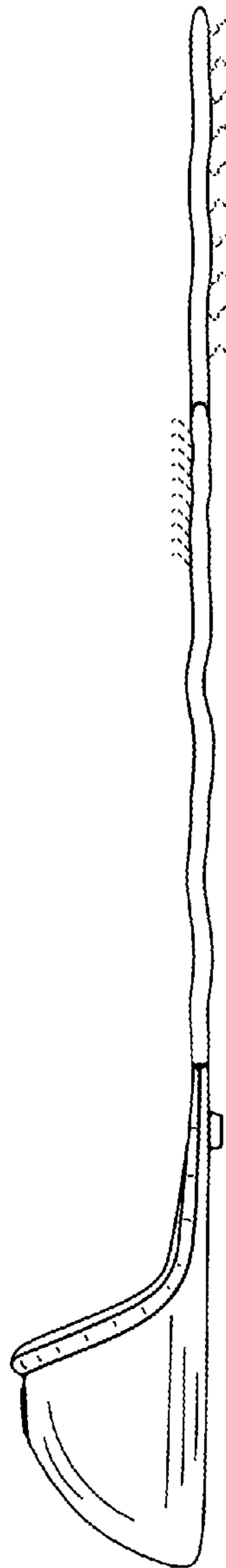

Figure 3

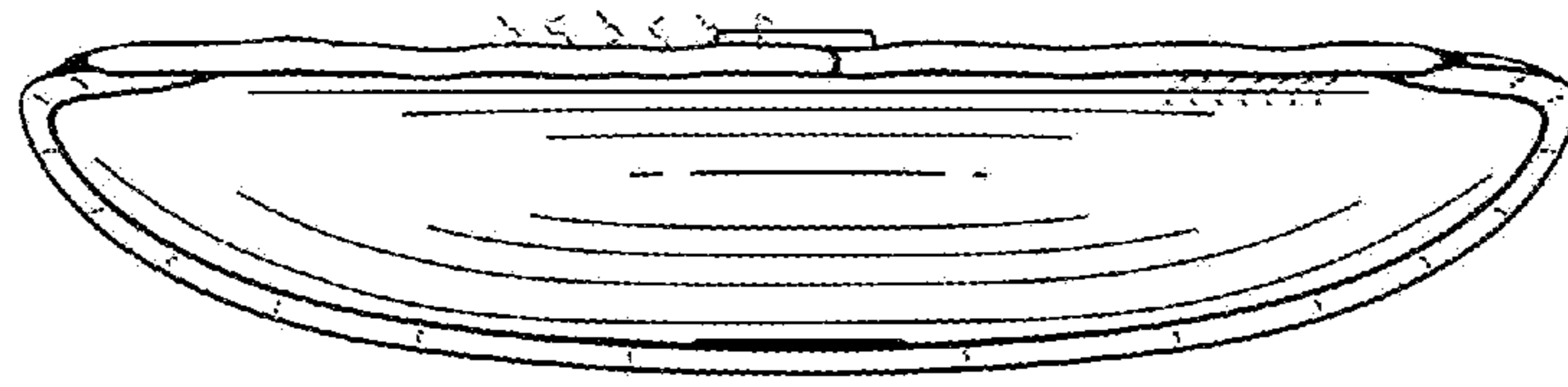

Figure 4

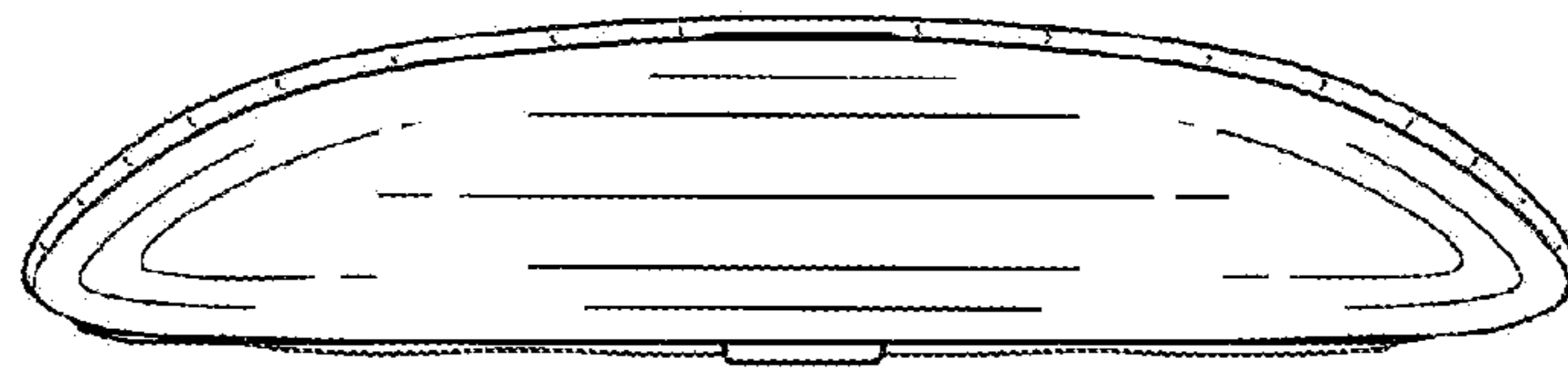

Figure 5

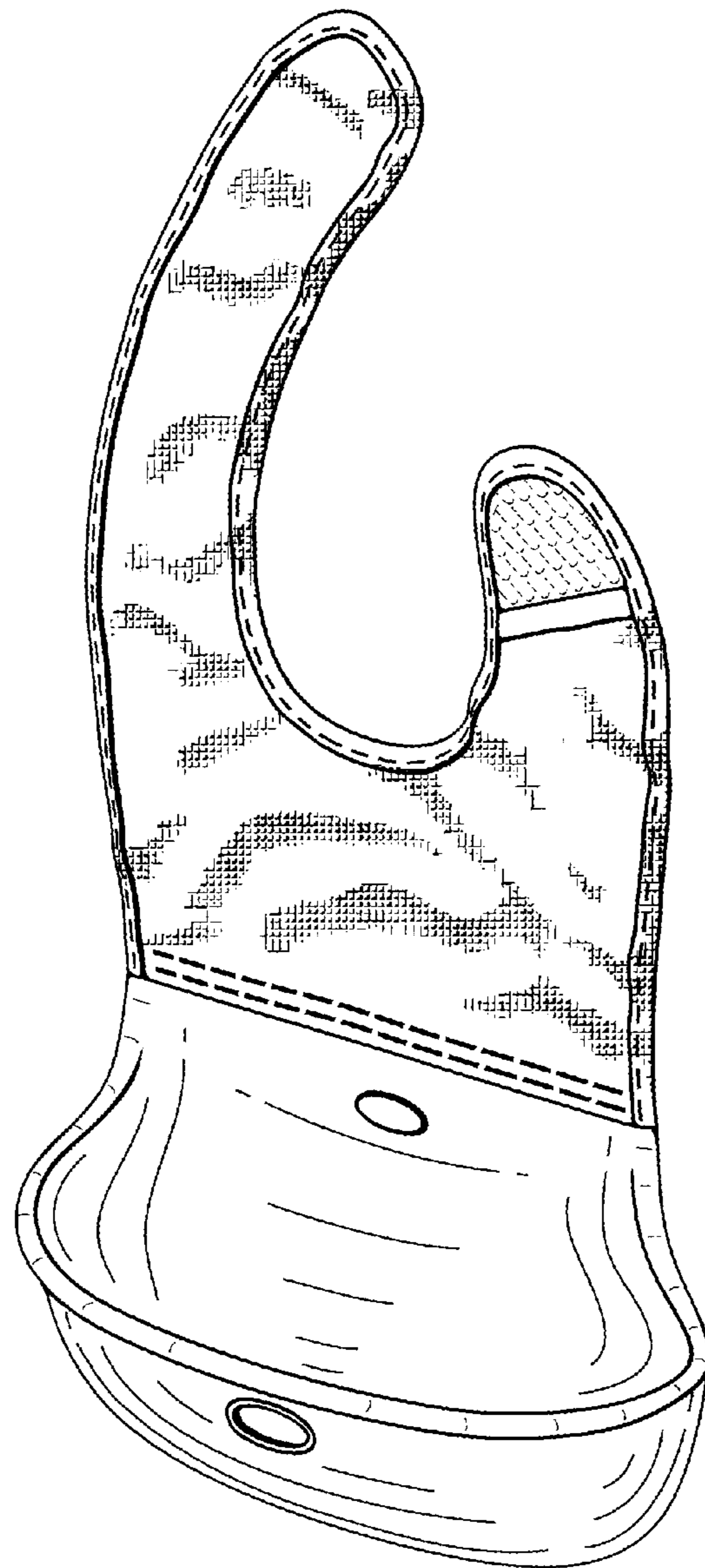

Figure 6

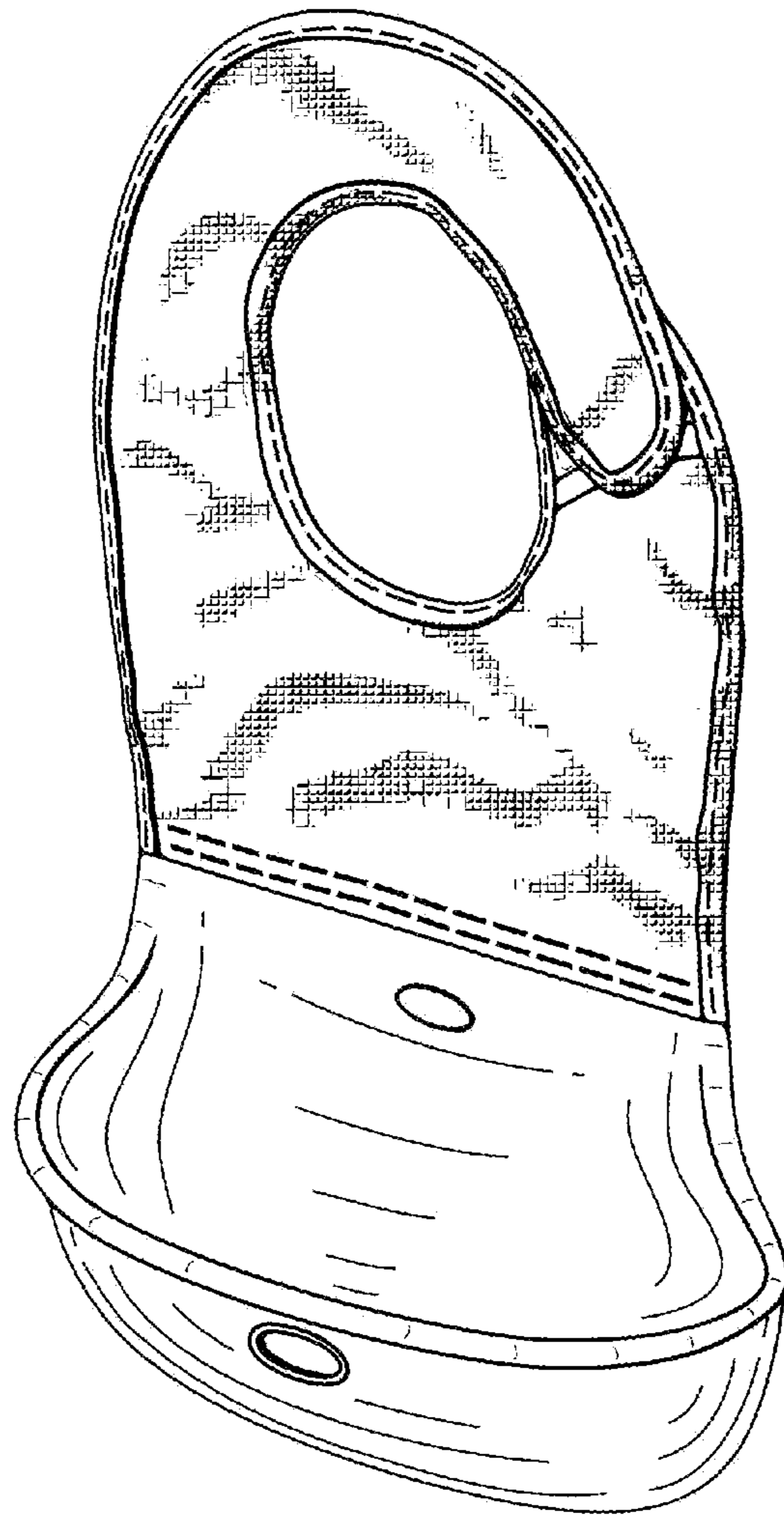

Figure 7



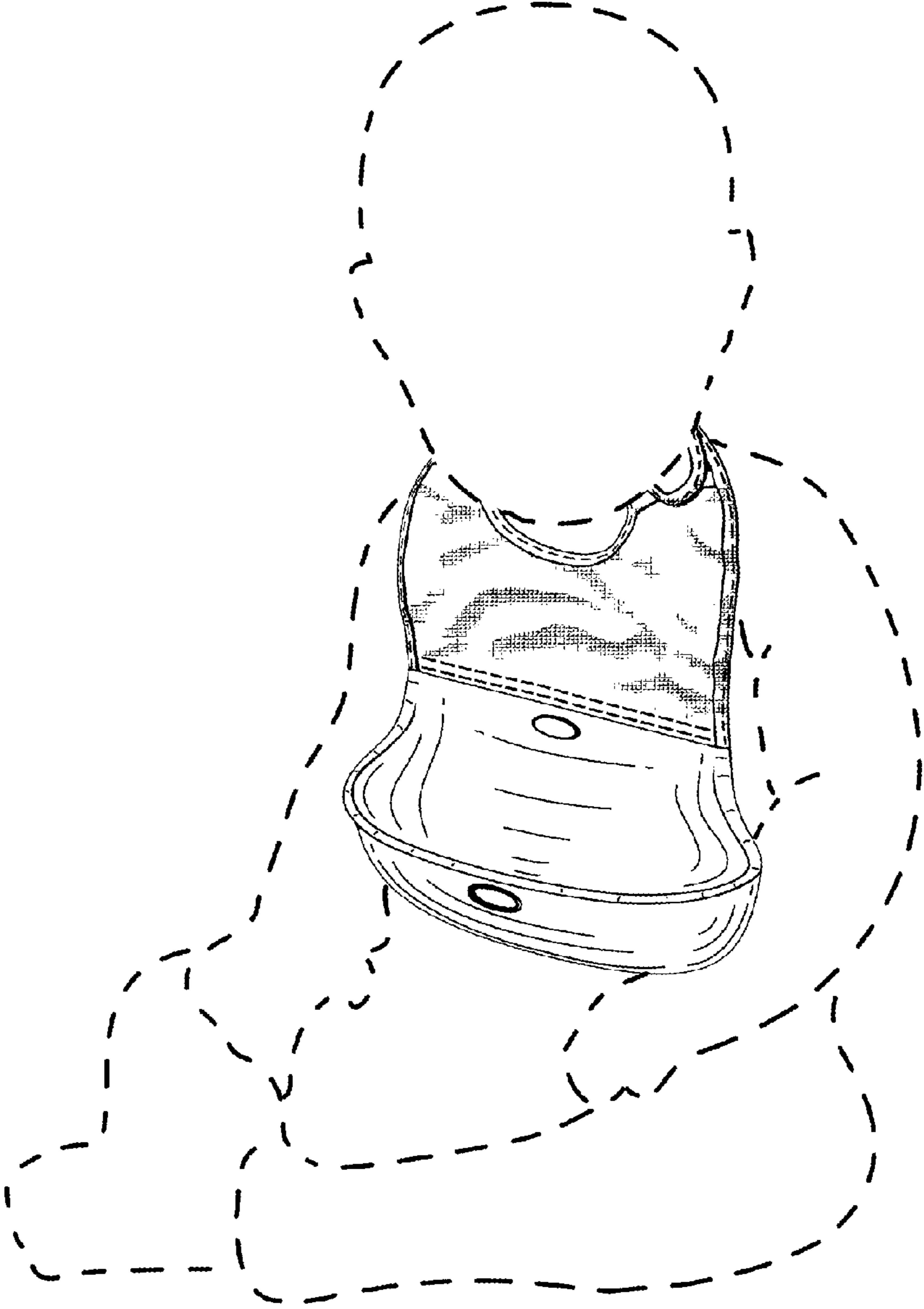

Figure 8

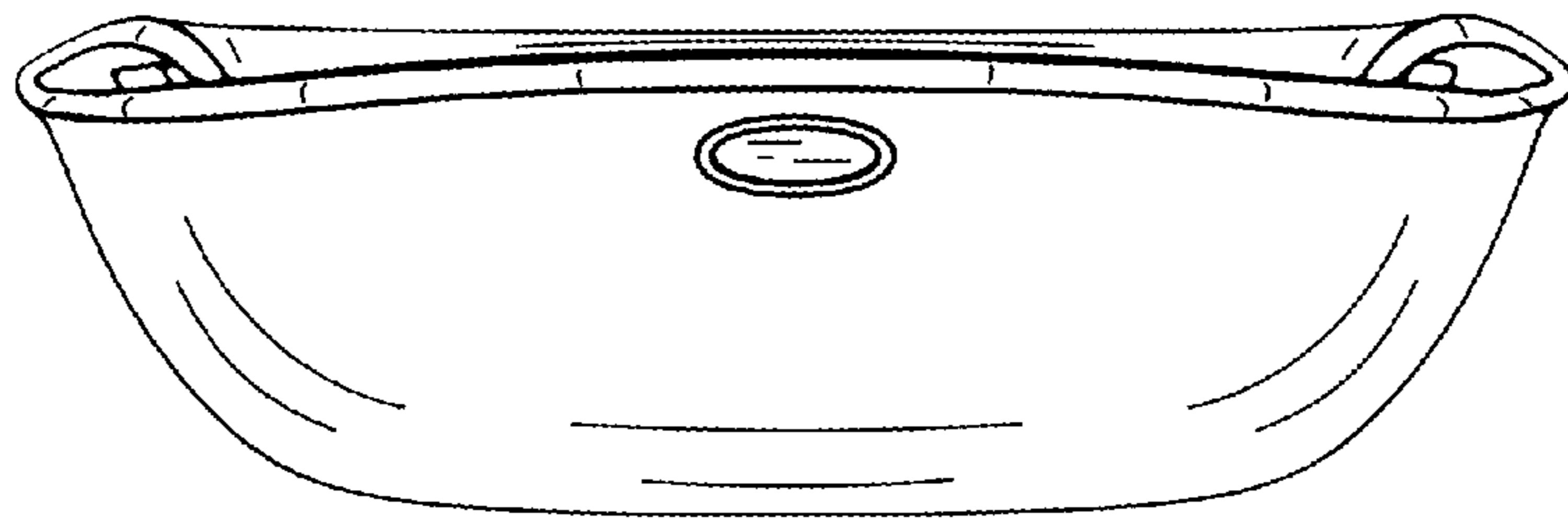

Figure 9

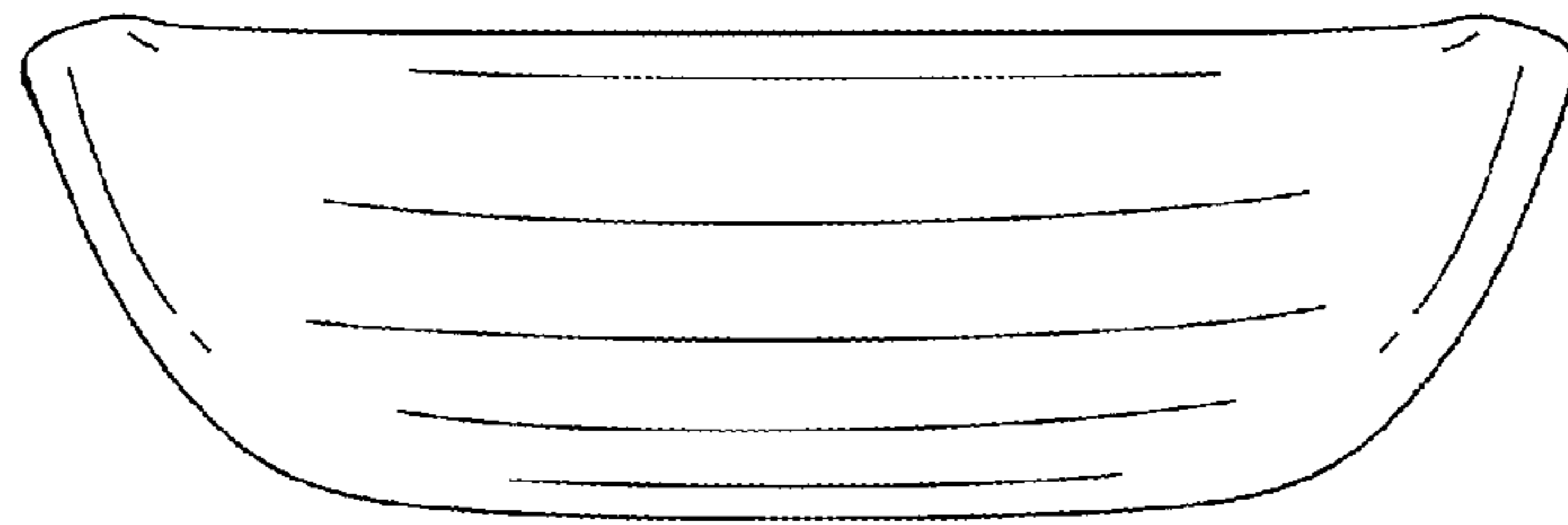

Figure 10

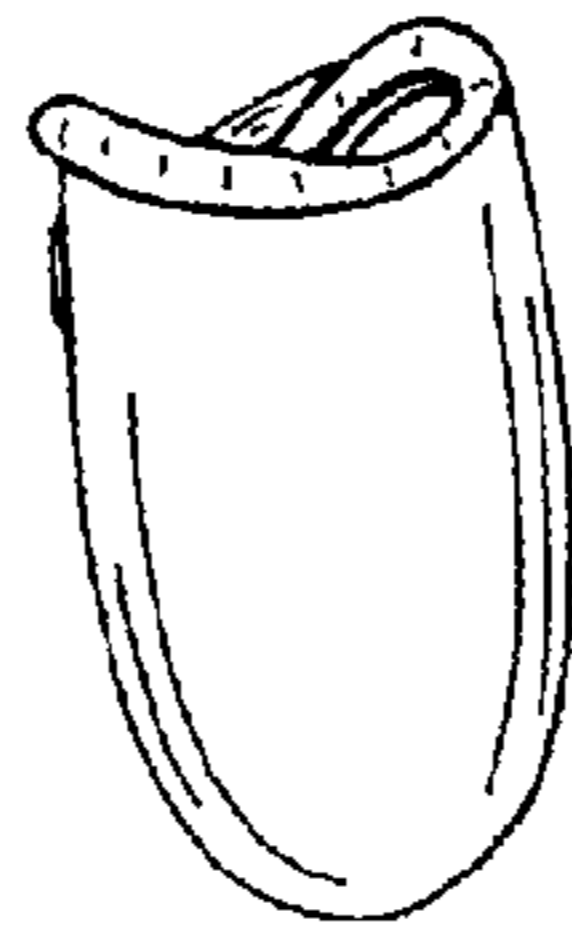

Figure 11

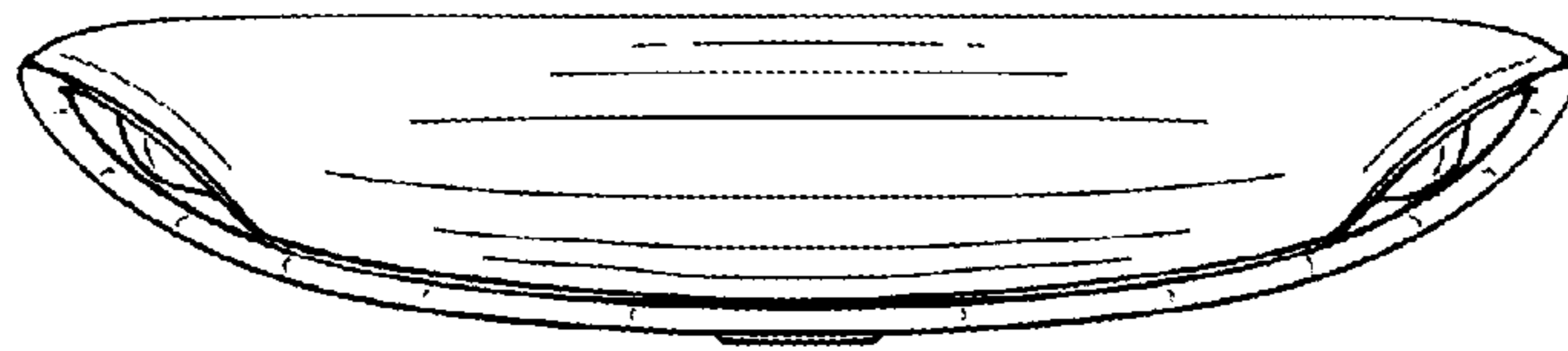

Figure 12

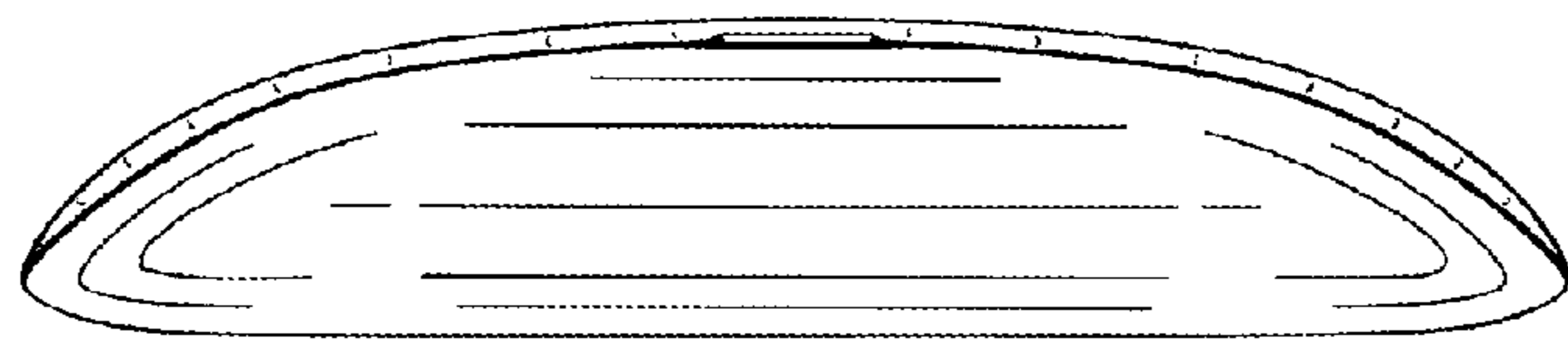

Figure 13

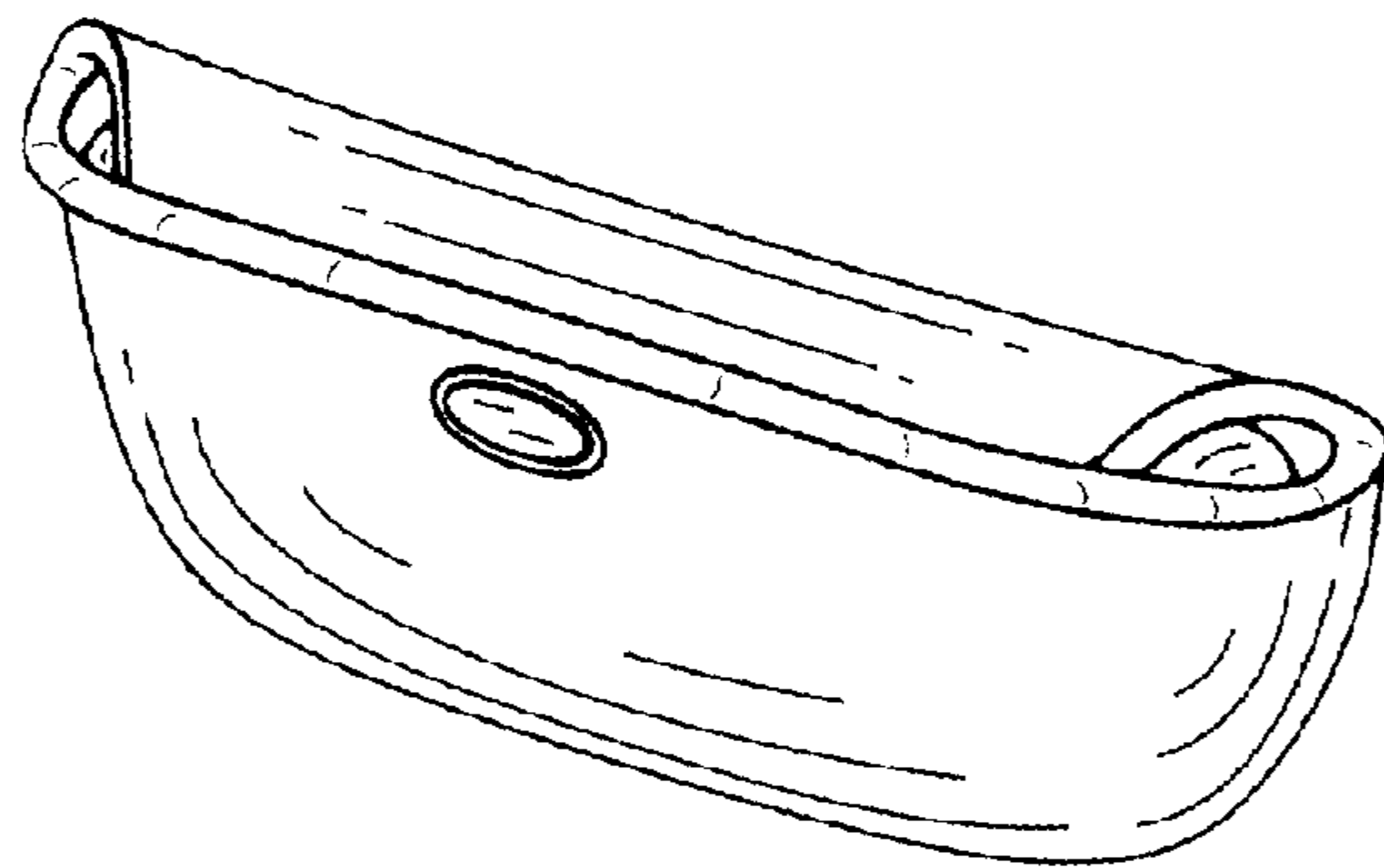

Figure 14