

US00D698099S

(12) **United States Design Patent**
Muhr et al.

(10) **Patent No.:** **US D698,099 S**
(45) **Date of Patent:** **** Jan. 21, 2014**

(54) **HUMMINGBIRD FEEDER**
(75) Inventors: **Jason Muhr**, Warrenville, IL (US);
Brian Povich, South Elgin, IL (US)
(73) Assignee: **Central Garden & Pet Company**,
Walnut Creek, CA (US)

1,239,151 A * 9/1917 Woods 119/464
1,372,371 A 3/1921 Ross
D65,098 S 7/1924 Brewster
D65,338 S 7/1924 Horn
1,525,561 A 2/1925 Baird

(Continued)

(**) Term: **14 Years**

GB 2 268 869 1/1994

(21) Appl. No.: **29/429,002**

OTHER PUBLICATIONS

(22) Filed: **Aug. 6, 2012**

Notice of Allowance issued Feb. 11, 2013 in Design U.S. Appl. No. 29/428,992.

(51) **LOC (10) Cl.** **30-03**

(52) **U.S. Cl.**
USPC **D30/124; D30/128; D30/127**

(Continued)

(58) **Field of Classification Search**
USPC D30/121, 124, 127, 128, 133, 114, 115,
D30/116, 117, 118, 119, 125, 126;
119/51.03, 57.8, 51.01, 52.2, 710, 711,
119/52.3, 464, 707, 709, 57.9, 124, 51.04;
43/2, 131; 47/86, 65, 65.5, 67, 39,
47/41.12, 79; 426/1, 439, 556; D11/121,
D11/120, 79, 117; 428/10, 18, 27; D7/352,
D7/356; 156/256, 263; 66/170; 99/372,
99/377, 403; 425/318, 395, 404; 248/175,
248/27.8; 211/85.31, 88.03, 23; 362/122,
362/227, 249.15, 249.16, 249.18, 806
See application file for complete search history.

Primary Examiner — Susan Moon Lee
(74) *Attorney, Agent, or Firm* — Womble Carlyle Sandridge
& Rice, LLP

(57) **CLAIM**
The ornamental design for a hummingbird feeder, as shown
and described.

DESCRIPTION

FIG. 1 is a perspective view of a hummingbird feeder in
accordance with the present invention;
FIG. 2 is a front elevation view of the hummingbird feeder of
FIG. 1;
FIG. 3 is a rear elevation view of the hummingbird feeder of
FIG. 1;
FIG. 4 is a right elevation view of the hummingbird feeder of
FIG. 1;
FIG. 5 is a left elevation view of the hummingbird feeder of
FIG. 1;
FIG. 6 is a top plan view of the hummingbird feeder of FIG.
1; and,
FIG. 7 is a bottom plan view of the hummingbird feeder of
FIG. 1.

(56) **References Cited**
U.S. PATENT DOCUMENTS

D10,260 S 9/1877 Hicks
D12,894 S 4/1882 Norse
290,135 A 12/1883 Stewart
324,757 A 8/1885 Dunham
D21,281 S 1/1892 Roe
D22,171 S 4/1893 Steffin
516,600 A * 3/1894 Higgins 119/77
D33,072 S 8/1900 Haviland
D37,243 S 11/1904 Helmschmied
D48,432 S 1/1916 Bagnulo

1 Claim, 5 Drawing Sheets

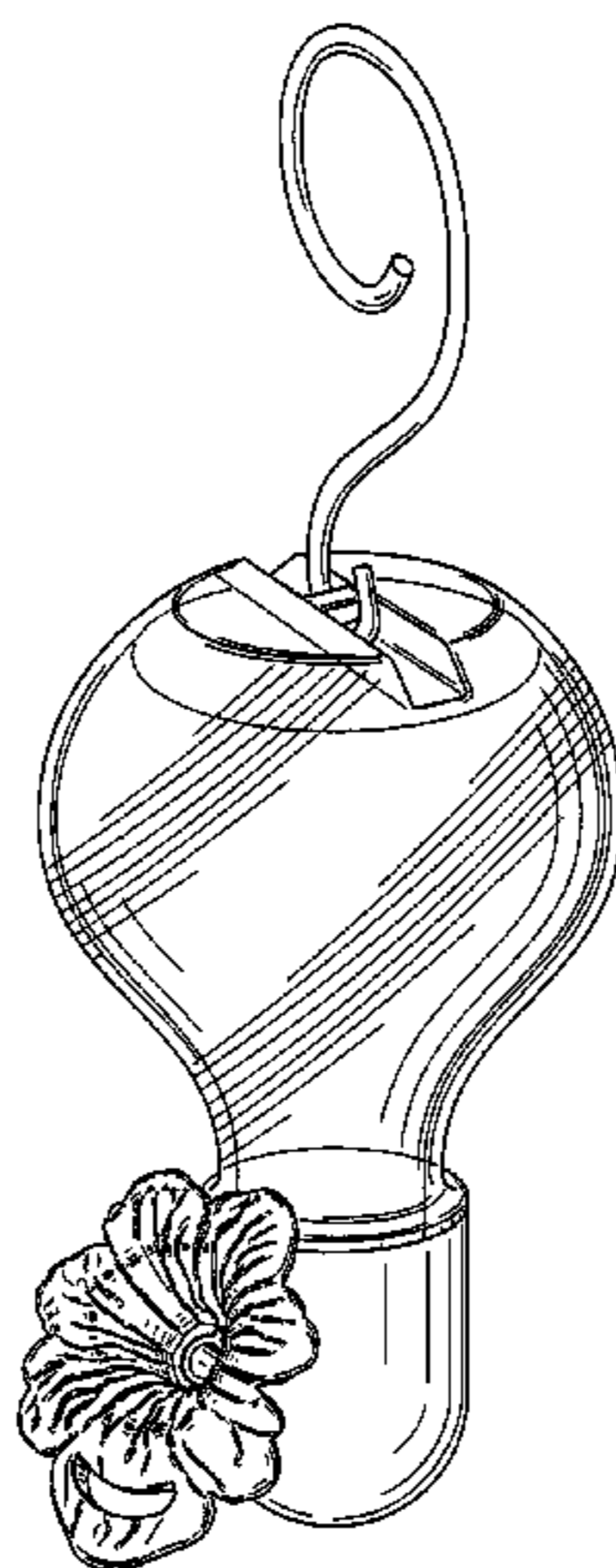

(56)

References Cited

U.S. PATENT DOCUMENTS

D69,894 S	4/1926	Kopp		3,292,589 A *	12/1966	Williams	119/77
D70,790 S	8/1926	Grunberg		3,292,840 A	12/1966	Schmidt	
D71,116 S	9/1926	Paye		3,301,217 A	1/1967	Prowinsky	
D71,830 S	1/1927	Fields		3,301,220 A	1/1967	Queen	
1,632,850 A *	6/1927	Raymond	362/255	D207,781 S	5/1967	Lowe, Jr.	
1,839,073 A	12/1931	Wright		D211,887 S	8/1968	Dearling	
D91,398 S	1/1934	Poppenhauser		3,399,650 A	9/1968	Goodman	
D94,913 S	3/1935	Kogan		3,400,890 A	9/1968	Gould	
D95,019 S	4/1935	Cooperstein		3,441,032 A *	4/1969	Barrett	132/275
2,046,854 A	7/1936	Simpson		3,459,294 A	8/1969	Crosman et al.	
D107,412 S	12/1937	Farber		3,471,964 A	10/1969	Rey et al.	
D107,889 S	1/1938	Welles		D216,199 S	12/1969	Brown, Jr.	
D109,966 S *	5/1938	Jacobs	D11/210	3,496,941 A	2/1970	Ketner	
2,116,699 A	5/1938	Hall		D217,006 S	3/1970	Michalek	
2,121,654 A	6/1938	Donchian		D219,158 S	11/1970	Gray et al.	
D118,819 S	2/1940	Herpel		D219,880 S	2/1971	Thrush	
D122,264 S	9/1940	Francine		D219,881 S	2/1971	Thrush	
2,234,903 A *	3/1941	Muench	431/125	3,574,901 A	4/1971	Nogue	
2,248,117 A	7/1941	Petry		3,589,322 A	6/1971	Hirokawa	
D132,967 S *	7/1942	Twombly	D11/146	3,648,661 A *	3/1972	Moore	119/53
2,330,705 A *	9/1943	Hamblet	431/125	3,673,909 A	7/1972	Birnkrant	
D137,527 S	3/1944	Ross		3,697,362 A *	10/1972	Zane et al.	428/26
2,353,853 A	7/1944	Sayford		D226,972 S	5/1973	Schwartz	
D138,872 S *	9/1944	Drell	D11/225	3,741,379 A	6/1973	Kappler et al.	
D143,162 S *	12/1945	Petersen	D11/146	D228,769 S *	10/1973	Bower	D30/128
D144,770 S	5/1946	Dreitzer		3,780,703 A *	12/1973	Boehland, Jr.	119/53
D145,976 S	11/1946	Dreitzer		D230,929 S	3/1974	Wang	
D151,423 S	10/1948	Weil		D231,253 S *	4/1974	Klassen	D26/26
2,462,679 A	2/1949	Rosenau		3,818,212 A *	6/1974	Rochford et al.	362/644
2,464,665 A	3/1949	Anderson		3,822,674 A *	7/1974	Tobin	119/53
D153,334 S	4/1949	Beaver		D235,399 S *	6/1975	Malnekoff	D6/513
D155,913 S *	11/1949	Lane	D26/125	D236,139 S	7/1975	Kilham	
D157,262 S *	2/1950	Jung	D9/451	3,913,527 A *	10/1975	Kilham	119/74
2,507,899 A	5/1950	Gilowitz		D237,619 S	11/1975	Levey	
D159,191 S	7/1950	Dreitzer		D237,736 S	11/1975	Lofgren	
D159,721 S	8/1950	Dreitzer		D239,182 S	3/1976	Kilham	
D161,814 S	2/1951	Baker et al.		3,944,138 A *	3/1976	Easton	239/18
D164,446 S	9/1951	Poglein		3,948,220 A	4/1976	Fiedler	
2,570,733 A *	10/1951	Thomas	119/72	4,030,451 A	6/1977	Miller	
D165,628 S	1/1952	Blazier		D245,715 S	9/1977	Eldridge	
D166,146 S	3/1952	Dreitzer		D249,134 S *	8/1978	Barr	D11/81
2,611,645 A	9/1952	Foreman		4,103,774 A	8/1978	Shingyouchi	
2,659,222 A	11/1953	Meier		4,106,657 A	8/1978	Dogliotti	
2,668,993 A	2/1954	Bair		D250,939 S	1/1979	Barr	
2,685,761 A *	8/1954	Schlessner	47/48.5	4,144,842 A	3/1979	Schlising	
D174,139 S	3/1955	Sadler		D252,288 S	7/1979	Kilham	
2,719,374 A *	10/1955	Paione	428/11	D253,095 S *	10/1979	Beatty	D11/121
2,763,421 A	9/1956	Bennett		4,233,941 A	11/1980	Webster	
2,800,187 A	7/1957	Lehder		D263,226 S	3/1982	Rehnmark	
2,845,895 A	8/1958	Balkauskas		4,323,035 A	4/1982	Piltch	
2,987,041 A	6/1961	Bard		4,327,669 A	5/1982	Blasbalg	
2,998,896 A	9/1961	Miller		4,355,597 A	10/1982	Blasbalg	
3,039,220 A *	6/1962	Fristot	428/26	D266,954 S	11/1982	Gordan	
D193,291 S	7/1962	Fristoe		D267,355 S	12/1982	Blasbalg	
3,050,619 A *	8/1962	Abramson	362/122	4,408,565 A	10/1983	Kerbs	
D194,683 S	2/1963	Clegg		D271,651 S	12/1983	Knutson	
D194,846 S	3/1963	Parry		D271,835 S	12/1983	Knutson	
3,088,295 A *	5/1963	Haines	63/20	4,434,745 A	3/1984	Perkins	
D195,628 S	7/1963	Andreae		D274,068 S	5/1984	Sverdlin	
D196,254 S *	9/1963	Dwyer et al.	D26/127	4,446,178 A	5/1984	Daugherty	
D196,256 S *	9/1963	Dwyer et al.	D26/127	D274,377 S	6/1984	Nock	
D196,258 S	9/1963	Dwyer et al.		D274,563 S	7/1984	Blasbalg	
D196,259 S *	9/1963	Dwyer et al.	D26/127	D277,514 S	2/1985	Bescherer	
D197,770 S	3/1964	Friedman et al.		D278,588 S	4/1985	Knutson	
3,125,069 A	3/1964	Fowler		4,523,546 A	6/1985	Latham	
3,137,610 A *	6/1964	Flynn	428/26	D280,689 S	9/1985	Knutson	
3,140,007 A	7/1964	Nettleship		D282,019 S	12/1985	Kilham	
D198,786 S	8/1964	Friedman et al.		D282,215 S	1/1986	Foreman	
3,146,955 A *	9/1964	Sabuco	362/122	4,588,618 A	5/1986	Wolfe	
3,151,415 A *	10/1964	James	47/48.5	4,595,369 A	6/1986	Downs	
3,161,559 A	12/1964	Tong		D285,273 S	8/1986	Laslo	
3,177,849 A *	4/1965	Isenberg	119/435	D285,840 S	9/1986	Poon	
3,204,277 A	9/1965	Visman et al.		D289,094 S	3/1987	Stephen	
3,244,150 A	4/1966	Blair		D289,210 S	4/1987	Tucker et al.	
D205,772 S	9/1966	Blair		4,664,066 A	5/1987	Steuernagel	
				D290,769 S	7/1987	Taylor	
				4,691,665 A	9/1987	Hefner	
				D292,762 S	11/1987	Williamson	
				4,732,112 A	3/1988	Fenner	

(56)

References Cited

U.S. PATENT DOCUMENTS

D299,770 S	2/1989	Coffer		D386,836 S	11/1997	Hunt	
4,866,952 A	9/1989	Hight et al.		5,682,835 A	11/1997	Walter	
4,901,673 A	2/1990	Overstreet		5,701,842 A	12/1997	Whittles	
4,919,981 A	4/1990	Levey et al.		5,725,152 A	3/1998	Akyu	
4,955,319 A	9/1990	Brucker		D393,421 S	4/1998	Kovens	
4,977,859 A	12/1990	Kilham		5,756,166 A	5/1998	Shinohara	
D315,193 S *	3/1991	Lach	D23/215	5,758,596 A	6/1998	Loiselle	
5,016,573 A	5/1991	Power		5,776,561 A	7/1998	Lindauer	
D317,332 S	6/1991	Williams et al.		D397,060 S	8/1998	Mayer	
D319,682 S	9/1991	Sharp et al.		5,806,460 A	9/1998	Klein	
D319,705 S	9/1991	Tsai		D399,611 S	10/1998	Ericson	
D320,097 S	9/1991	Vajtay		5,816,686 A	10/1998	Wang et al.	
5,050,801 A	9/1991	Ferrari		5,829,382 A	11/1998	Garrison	
D320,875 S	10/1991	Kilham		D402,914 S *	12/1998	Andersen	D11/121
5,062,388 A	11/1991	Kilham		D404,981 S	2/1999	Wu	
5,063,877 A	11/1991	Riggi		D408,947 S	4/1999	Mandell	
D322,309 S	12/1991	King		5,893,335 A	4/1999	Goodwin	
5,077,102 A	12/1991	Chong		D410,756 S	6/1999	Kleinberg	
5,083,881 A	1/1992	Yoshinaga		D413,487 S	9/1999	Vitali	
5,111,772 A	5/1992	Lipton		D414,245 S	9/1999	Watson	
D328,310 S	7/1992	Yoshinaga		5,947,054 A	9/1999	Liethen	
5,140,945 A	8/1992	Barnhart		5,947,582 A	9/1999	Huang	
D329,488 S	9/1992	Santagada		5,964,183 A	10/1999	Czipri	
5,150,665 A	9/1992	Boaz		5,970,913 A	10/1999	Bloedorn	
5,165,363 A	11/1992	McGinty		5,992,761 A	11/1999	Santa Cruz et al.	
5,168,830 A	12/1992	Deglis		D417,887 S	12/1999	Coipel	
5,195,463 A *	3/1993	Lorenzana et al.	119/77	6,012,441 A	1/2000	Klein	
D335,006 S	4/1993	Blasbalg		6,025,042 A	2/2000	Kligman et al.	
5,203,281 A	4/1993	Harwich		D421,814 S	3/2000	Meck	
5,207,180 A *	5/1993	Graham	119/52.3	D422,350 S	4/2000	Wu	
D337,548 S	7/1993	Winkelman		6,047,661 A	4/2000	Lush	
5,224,652 A	7/1993	Kessler		6,067,934 A	5/2000	Harwich	
D338,427 S	8/1993	Liou		6,070,554 A	6/2000	Wilson	
5,247,904 A	9/1993	Anderson		6,073,582 A	6/2000	Lush	
5,287,979 A	2/1994	Bourgeois		D430,659 S	9/2000	Zaragoza et al.	
5,289,796 A	3/1994	Armstrong		6,119,627 A	9/2000	Banyas et al.	
D347,714 S	6/1994	Maple		6,153,274 A	11/2000	Koo	
D349,568 S *	8/1994	El-Assir	D23/367	6,156,088 A	12/2000	Cardarelli	
D349,981 S	8/1994	Fasino		D438,139 S	2/2001	Mozena	
D350,419 S	9/1994	Long		D438,283 S	2/2001	Hsu	
D351,262 S	10/1994	Fasino		D439,359 S	3/2001	Feng	
D351,691 S	10/1994	Lipton		D440,361 S	4/2001	Colwell	
5,353,742 A *	10/1994	Mauritz	119/77	D441,923 S	5/2001	Garcia-Lucio et al.	
D352,001 S	11/1994	Hsieh		6,234,699 B1	5/2001	Brode	
D354,979 S	1/1995	Tsuji		6,253,706 B1	7/2001	Sloop	
D354,984 S	1/1995	Tsuji		D446,852 S	8/2001	Johansen et al.	
5,377,617 A	1/1995	Harwich		D447,600 S	9/2001	Micinilio	
5,377,619 A	1/1995	Katz		D448,126 S	9/2001	Colwell	
5,398,642 A	3/1995	Harwich		D450,892 S	11/2001	Garcia-Lucio et al.	
D357,766 S	4/1995	Prince et al.		D450,893 S	11/2001	Garcia-Lucio et al.	
D360,710 S	7/1995	Colwell		D452,049 S	12/2001	Stokes	
D361,873 S	8/1995	Nottingham		6,344,279 B1	2/2002	Shu	
5,450,816 A	9/1995	Santa Cruz		6,348,691 B1	2/2002	Sandell	
D362,922 S	10/1995	Prince et al.		D454,669 S	3/2002	Lieb	
D363,140 S	10/1995	Accumanno et al.		D456,225 S	4/2002	Kohn et al.	
5,454,348 A	10/1995	Colwell et al.		6,383,164 B1	5/2002	Johansen et al.	
5,479,878 A	1/1996	Coulter		D459,824 S	7/2002	Leen	
D367,134 S	2/1996	Bescherer		D461,523 S	8/2002	Chen	
D368,051 S	3/1996	Snoddy		D461,577 S	8/2002	Cheong	
D368,337 S	3/1996	Dickinson		D462,478 S	9/2002	Johnson	
5,503,288 A	4/1996	Conconi		6,453,843 B2	9/2002	Bescherer	
5,507,249 A *	4/1996	Shaw	119/72	D464,745 S	10/2002	Mangini et al.	
D370,307 S	5/1996	Chen		6,463,878 B1	10/2002	Moody	
D370,313 S	5/1996	Nottingham		D466,255 S	11/2002	Kuelbs	
D370,747 S	6/1996	Madigan		6,481,375 B1	11/2002	Scalf	
D372,325 S	7/1996	Hackworth		D466,654 S	12/2002	Ridyard	
5,533,467 A	7/1996	Lancia		6,499,430 B2	12/2002	Garcia-Lucio et al.	
5,558,040 A	9/1996	Colwell		D470,621 S	2/2003	Cheng	
D379,651 S	6/1997	Rondeau		D470,630 S	2/2003	Kuelbs	
D379,652 S	6/1997	Okamoto		D471,327 S	3/2003	Kuelbs	
D380,151 S	6/1997	du Grenier et al.		D472,351 S	3/2003	Griffin	
5,640,927 A	6/1997	Klein		D473,333 S	4/2003	Willmorth	
D381,444 S	7/1997	Yuen		D474,107 S	5/2003	Osborne	
D382,376 S	8/1997	Bescherer		6,558,223 B1	5/2003	Matthews	
D386,835 S	11/1997	Passamare		6,592,053 B2	7/2003	Erickson et al.	
				6,598,561 B1	7/2003	Johns	
				D478,685 S	8/2003	Wu	
				D481,115 S	10/2003	Wu	
				6,647,921 B2	11/2003	Stokes	

(56)

References Cited

U.S. PATENT DOCUMENTS

D483,139 S	12/2003	Kuelbs	D593,800 S	6/2009	Hone
6,659,041 B1	12/2003	Curls	D597,439 S	8/2009	Williams
6,662,745 B2	12/2003	Chrisco et al.	D597,648 S	8/2009	Heflin
6,672,249 B2	1/2004	Garcia-Lucio et al.	D598,808 S	8/2009	Rosenkotter
D486,272 S	2/2004	Donegan	D602,650 S	10/2009	Garcia-Lucio et al.
D486,384 S	2/2004	Fahy et al.	7,600,487 B2 *	10/2009	Stone et al. 119/72
D488,856 S	4/2004	Millan	D603,567 S *	11/2009	Chen et al. D30/124
D490,941 S	6/2004	Rich	D604,106 S	11/2009	Gold et al.
D492,748 S *	7/2004	Sungay D22/112	D604,826 S	11/2009	Lesniak
6,758,164 B2	7/2004	Rich	7,611,265 B2	11/2009	Laporte
6,767,117 B2	7/2004	DeArmond	D606,708 S	12/2009	McMullen
D496,223 S	9/2004	Clarichetti	D606,709 S	12/2009	McMullen
6,792,891 B1	9/2004	Coburn et al.	7,634,974 B1	12/2009	Puckett et al.
D498,335 S	11/2004	Donegan	D609,864 S	2/2010	Tsai
D499,334 S	12/2004	Murray, Jr.	D612,531 S	3/2010	Smith
6,830,733 B2	12/2004	Stanley	D612,549 S	3/2010	Garcia-Lucio et al.
6,866,004 B1	3/2005	Lush	7,685,969 B2	3/2010	Stone et al.
D504,082 S	4/2005	Weiser et al.	D614,279 S	4/2010	Lesniak et al.
D504,746 S	5/2005	Lee	7,739,982 B2	6/2010	Cote
D505,062 S	5/2005	Suero	7,743,732 B2	6/2010	Webber
D506,527 S	6/2005	Chang	D619,692 S	7/2010	Hami et al.
6,901,882 B2	6/2005	Kuelbs	D620,636 S	7/2010	Holder
D507,360 S	7/2005	Yuen	D621,127 S	8/2010	Roskam
D508,824 S	8/2005	Vendl et al.	D623,805 S	9/2010	Vosbikian
D509,315 S	9/2005	Weiser et al.	7,789,040 B2	9/2010	Liethen
D514,748 S	2/2006	Sweasy	D625,401 S	10/2010	Perman
D514,749 S	2/2006	Fort et al.	D630,791 S	1/2011	Wanders
D515,247 S	2/2006	Jung	7,861,671 B2 *	1/2011	Carter et al. 119/72
D516,944 S	3/2006	Weiser et al.	D632,379 S	2/2011	Perman
D517,749 S	3/2006	Jung et al.	D632,583 S	2/2011	Eisenberger et al.
7,025,206 B2	4/2006	Sommer	D632,994 S	2/2011	Deruelles
7,032,538 B1	4/2006	Lush	7,891,319 B2 *	2/2011	Stone et al. 119/72
D520,898 S	5/2006	Sugama	D633,659 S	3/2011	Lai
D521,139 S	5/2006	Wu	7,918,184 B2	4/2011	Humphries et al.
D521,193 S	5/2006	Lombard	D637,087 S	5/2011	Eisenberger et al.
D521,689 S *	5/2006	Lombard D30/124	D637,186 S	5/2011	David
D521,894 S	5/2006	Sugama	D638,113 S	5/2011	Havive
D522,119 S	5/2006	Baraky et al.	D638,588 S	5/2011	Vosbikian
D523,522 S	6/2006	DeBoer et al.	7,938,262 B1	5/2011	Havive et al.
D524,490 S	7/2006	Obenshain	7,946,249 B2	5/2011	Colvin et al.
D525,903 S	8/2006	Weiser et al.	7,946,734 B2	5/2011	Laporte
D527,472 S	8/2006	Barracrough et al.	D640,584 S	6/2011	Rockefeller
D536,838 S	2/2007	Colvin et al.	D644,274 S	8/2011	Nelson et al.
D536,839 S	2/2007	Colvin et al.	7,992,520 B2	8/2011	Lush
D537,358 S	2/2007	Donegan et al.	D645,309 S	9/2011	Anton Villa
D538,485 S *	3/2007	Degironne D30/124	8,011,323 B2 *	9/2011	Vaughn et al. 119/72
D538,701 S	3/2007	Williams	8,021,027 B2	9/2011	Galipeau
7,185,606 B1 *	3/2007	Racine 119/57.8	8,028,658 B2	10/2011	Stone et al.
7,198,004 B1	4/2007	Lush	D648,903 S	11/2011	Lush
7,201,358 B2	4/2007	Nichols et al.	D649,299 S	11/2011	Lush
D542,147 S	5/2007	Donegan et al.	D649,300 S	11/2011	Lush
D543,132 S *	5/2007	Sexton et al. D11/121	8,051,803 B2 *	11/2011	Gauker et al. 119/81
D543,133 S *	5/2007	Sexton et al. D11/121	8,056,507 B2	11/2011	Lush
D543,481 S *	5/2007	Sexton et al. D11/121	D652,175 S *	1/2012	Schatz D30/124
7,231,890 B2	6/2007	Colvin	D656,279 S	3/2012	Tu
7,234,418 B2	6/2007	Fort et al.	D656,389 S	3/2012	Goodman et al.
D545,719 S *	7/2007	Sexton et al. D11/121	8,156,894 B1 *	4/2012	Krah 119/52.2
D546,239 S *	7/2007	Sexton et al. D11/121	D663,489 S	7/2012	Van Dyk
D546,506 S	7/2007	Barszcz	D665,153 S	8/2012	Suiter
7,237,507 B1	7/2007	Colwell	8,245,667 B2	8/2012	Mateer et al.
7,244,038 B2	7/2007	Fotherby	8,276,541 B2	10/2012	LoRocco et al.
7,258,075 B1	8/2007	Jones	8,291,861 B2 *	10/2012	Hepp et al. 119/65
D551,331 S	9/2007	Butler et al.	D670,194 S	11/2012	Dubow
D551,785 S	9/2007	Montgomery	D671,277 S	11/2012	Vosbikian
D555,841 S	11/2007	Fan	D672,277 S	12/2012	Dubow
D558,320 S	12/2007	Butler et al.	8,347,818 B2 *	1/2013	Cowger et al. 119/74
D566,344 S	4/2008	Schatz	D683,911 S *	6/2013	Muhr et al. D30/124
D568,453 S	5/2008	Wu	8,522,718 B2 *	9/2013	Cruz et al. 119/72
D569,301 S	5/2008	Fotherby	2001/0029899 A1 *	10/2001	Arlitt 119/77
D577,851 S	9/2008	Yurich	2001/0032592 A1	10/2001	Bescherer
7,418,923 B1	9/2008	Banyas et al.	2002/0078897 A1 *	6/2002	Garcia-Lucio et al. 119/72
D580,229 S	11/2008	Sawatsky	2002/0092475 A1	7/2002	Paynton
7,497,685 B2	3/2009	Kubicek et al.	2003/0033985 A1	2/2003	Hardison
7,503,282 B1	3/2009	Lush	2003/0097995 A1 *	5/2003	Garcia-Lucio et al. 119/72
7,506,611 B1	3/2009	Lush	2004/0103851 A1 *	6/2004	Hunter 119/72
			2004/0118354 A1 *	6/2004	Cox et al. 119/72
			2005/0084413 A1 *	4/2005	Stanley 422/5
			2006/0065202 A1	3/2006	Fort et al.
			2006/0118056 A1	6/2006	Kuelbs

(56)

References Cited

U.S. PATENT DOCUMENTS

2006/0162665 A1 7/2006 George
 2006/0260553 A1 11/2006 Cote
 2007/0272161 A1* 11/2007 Stone et al. 119/51.01
 2007/0289540 A1* 12/2007 Stone et al. 119/72
 2008/0035068 A1* 2/2008 Gou 119/72
 2008/0087225 A1* 4/2008 Lin 119/72
 2008/0105206 A1* 5/2008 Rich et al. 119/57.9
 2008/0134979 A1 6/2008 Crocker
 2008/0141944 A1 6/2008 Liethen
 2008/0205069 A1 8/2008 Laporte
 2008/0232111 A1 9/2008 Laporte
 2008/0251025 A1 10/2008 Guay et al.
 2009/0071408 A1 3/2009 Wechsler
 2009/0078211 A1* 3/2009 Charlton 119/77
 2009/0133636 A1 5/2009 Richmond
 2009/0145875 A1* 6/2009 Gardner 215/228
 2009/0159008 A1 6/2009 Humphries
 2009/0199777 A1* 8/2009 Webber 119/74
 2009/0308321 A1* 12/2009 Szczygiel-Durante 119/72
 2010/0024738 A1* 2/2010 Chen et al. 119/72
 2010/0061091 A1 3/2010 Galipeau
 2010/0089328 A1* 4/2010 Puckett et al. 119/51.01
 2010/0224132 A1* 9/2010 Gauker et al. 119/80
 2010/0229801 A1* 9/2010 Stone et al. 119/74
 2010/0242848 A1 9/2010 Vaughn et al.
 2010/0251967 A1 10/2010 Mateer et al.
 2010/0288200 A1 11/2010 Lush
 2010/0288201 A1 11/2010 Lush
 2011/0011345 A1* 1/2011 LoRocco et al. 119/72
 2011/0067635 A1 3/2011 Puckett et al.
 2011/0083609 A1 4/2011 Cote
 2011/0094449 A1 4/2011 George
 2011/0100299 A1 5/2011 Colwell
 2011/0100300 A1 5/2011 Carter et al.

2011/0168101 A1 7/2011 Guay et al.
 2011/0239949 A1* 10/2011 Abbott 119/72
 2011/0277691 A1* 11/2011 Sundquist 119/72
 2011/0297095 A1* 12/2011 Cruz et al. 119/80
 2012/0060762 A1 3/2012 Cowger et al.
 2012/0079988 A1 4/2012 Vaughn et al.
 2012/0132145 A1* 5/2012 Gauker et al. 119/72
 2012/0216750 A1* 8/2012 Cruz et al. 119/72
 2012/0279454 A1 11/2012 Gauker et al.
 2012/0285387 A1* 11/2012 Humphries et al. 119/53

OTHER PUBLICATIONS

Notice of Allowance issued Feb. 7, 2013 in Design U.S. Appl. No. 29/428,993.
 Notice of Allowance issued Feb. 6, 2013 in Design U.S. Appl. No. 29/428,995.
 Notice of Allowance issued Feb. 6, 2013 in Design U.S. Appl. No. 29/429,007.
 Design U.S. Appl. No. 29/422,227, filed May 17, 2012.
 U.S. Appl. No. 13/474,308, filed May 17, 2012.
 Design U.S. Appl. No. 29/424,217, filed Jun. 8, 2012.
 Notice of Allowance issued Sep. 28, 2012 in Design U.S. Appl. No. 29/424,217.
 U.S. Appl. No. 13/550,670, filed Jul. 12, 2012.
 Design U.S. Appl. No. 29/428,992, filed Aug. 6, 2012.
 Design U.S. Appl. No. 29/428,993, filed Aug. 6, 2012.
 Design U.S. Appl. No. 29/428,995, filed Aug. 6, 2012.
 Design U.S. Appl. No. 29/429,000, filed Aug. 6, 2012.
 Design U.S. Appl. No. 29/429,001, filed Aug. 6, 2012.
 Design U.S. Appl. No. 29/429,003, filed Aug. 6, 2012.
 Design U.S. Appl. No. 29/429,004, filed Aug. 6, 2012.
 Design U.S. Appl. No. 29/429,006, filed Aug. 6, 2012.
 Design U.S. Appl. No. 29/429,007, filed Aug. 6, 2012.
 Design U.S. Appl. No. 29/429,009, filed Aug. 6, 2012.

* cited by examiner

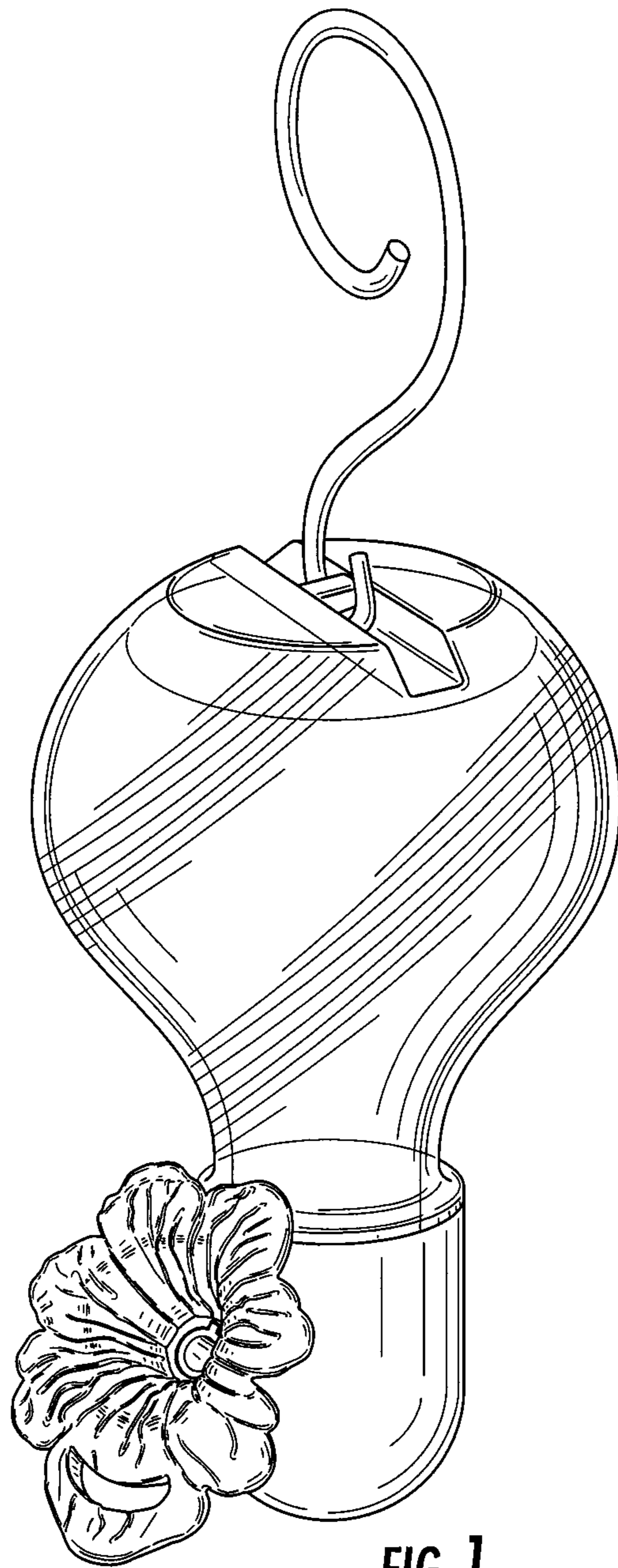

FIG. 1

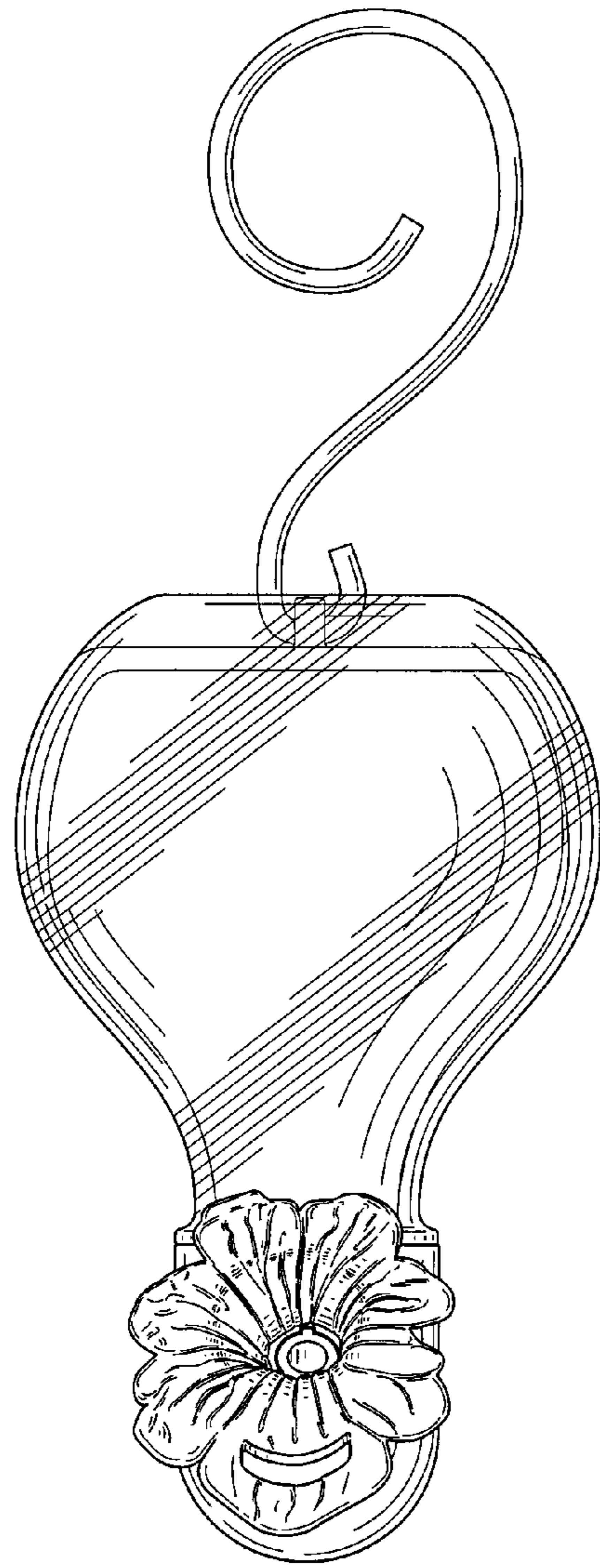

FIG. 2

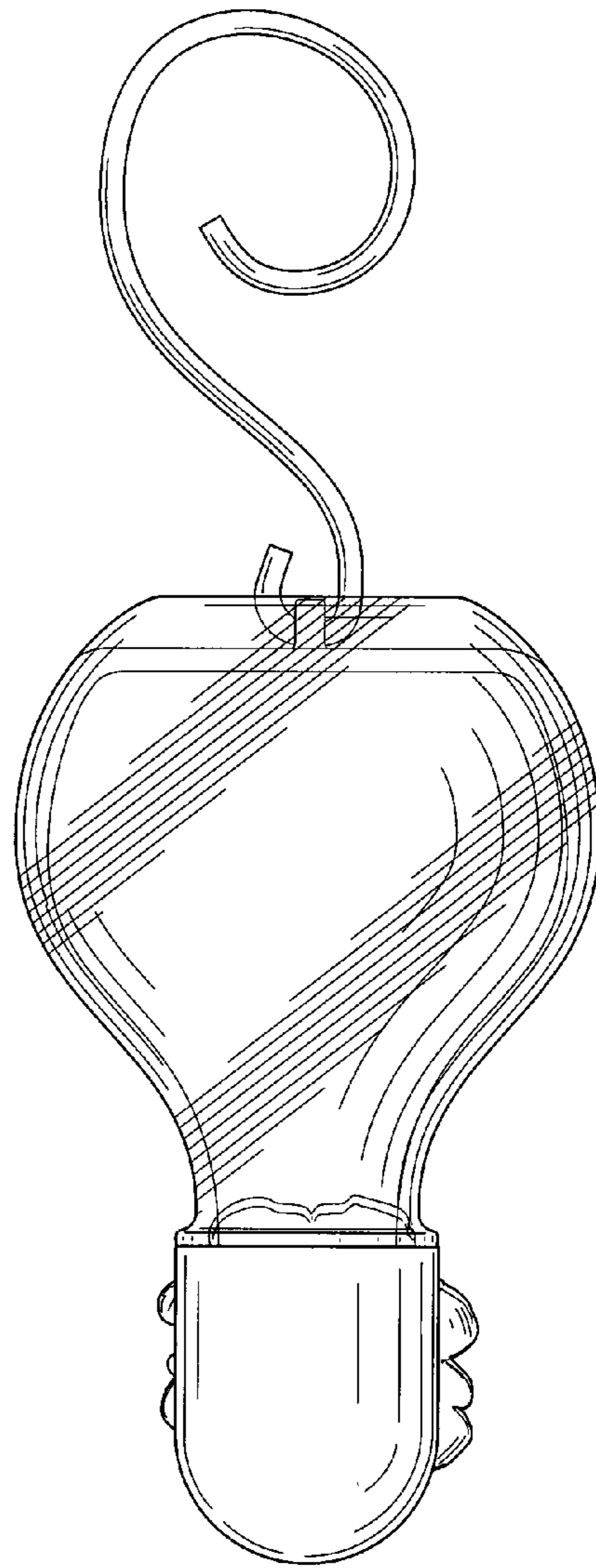

FIG. 3

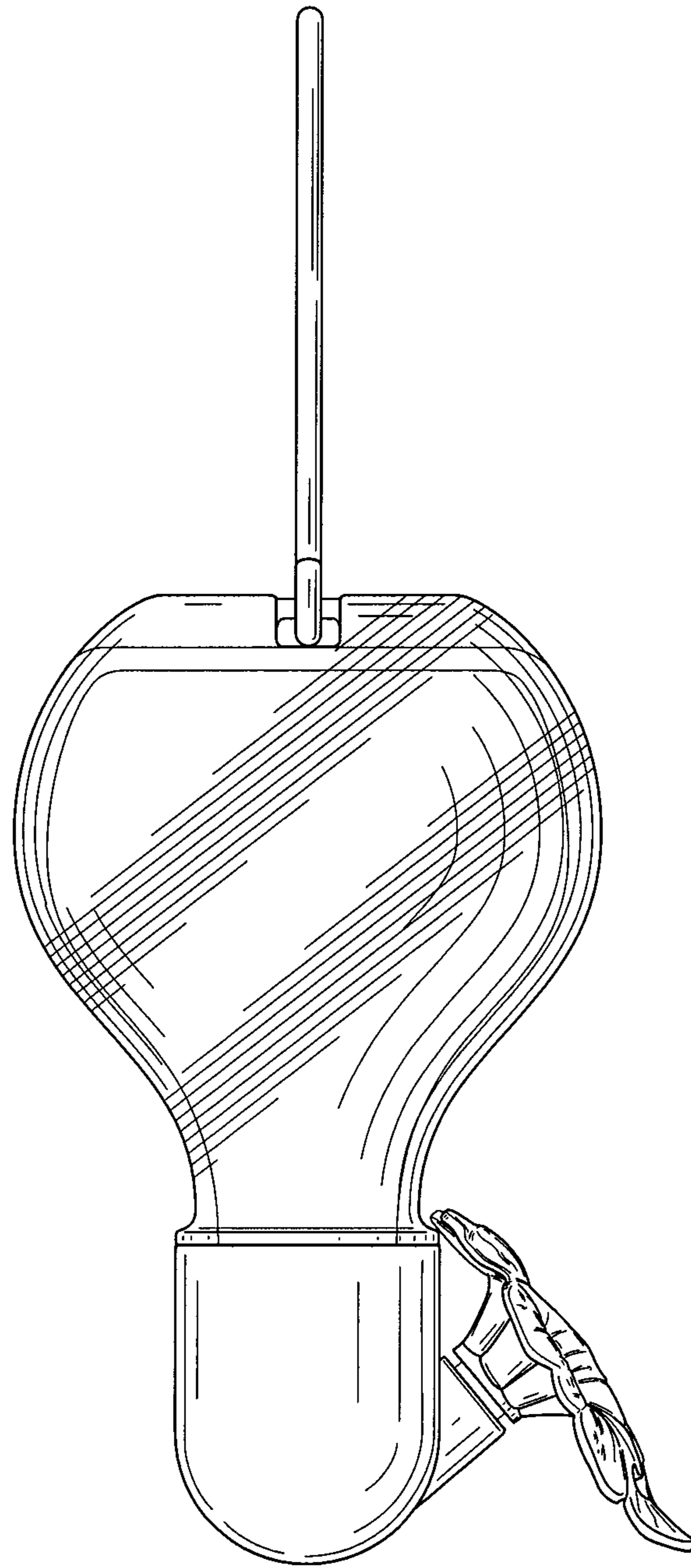

FIG. 4

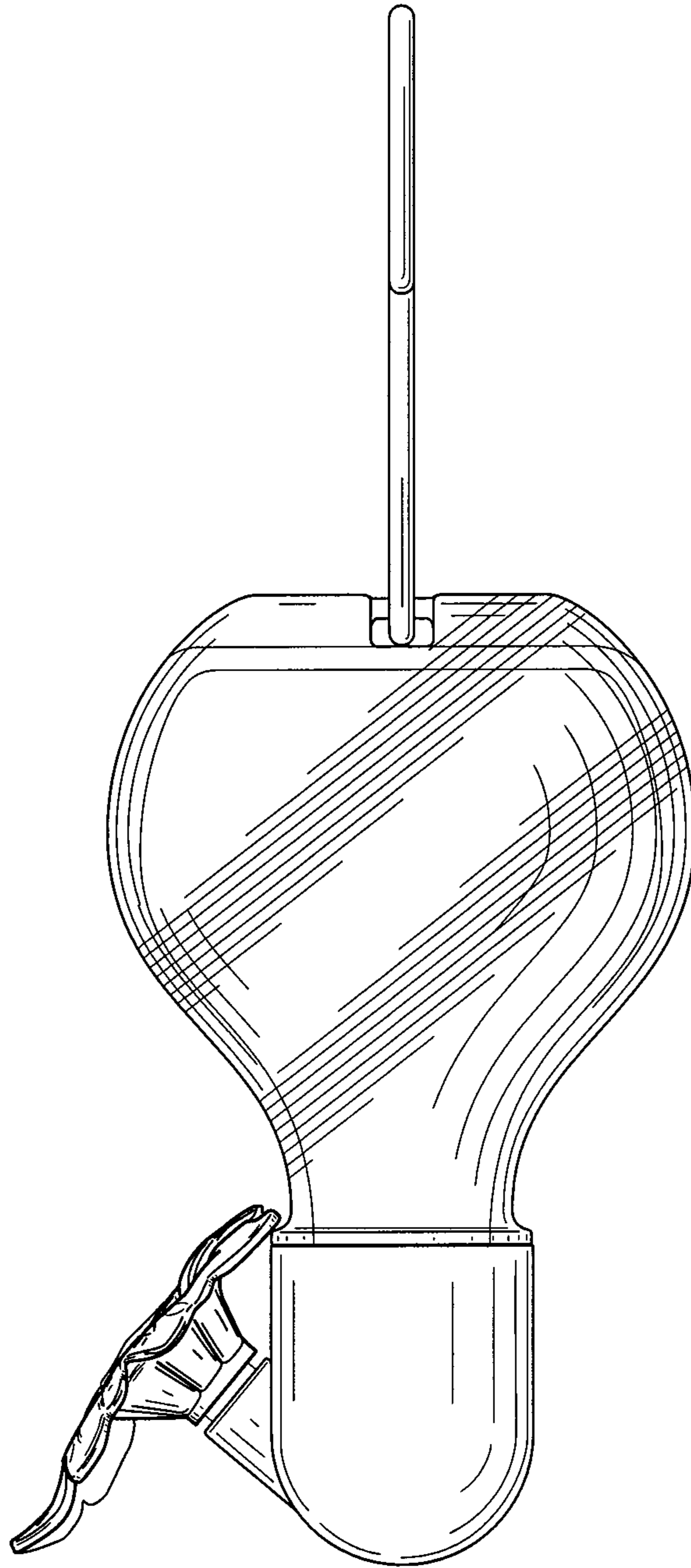

FIG. 5

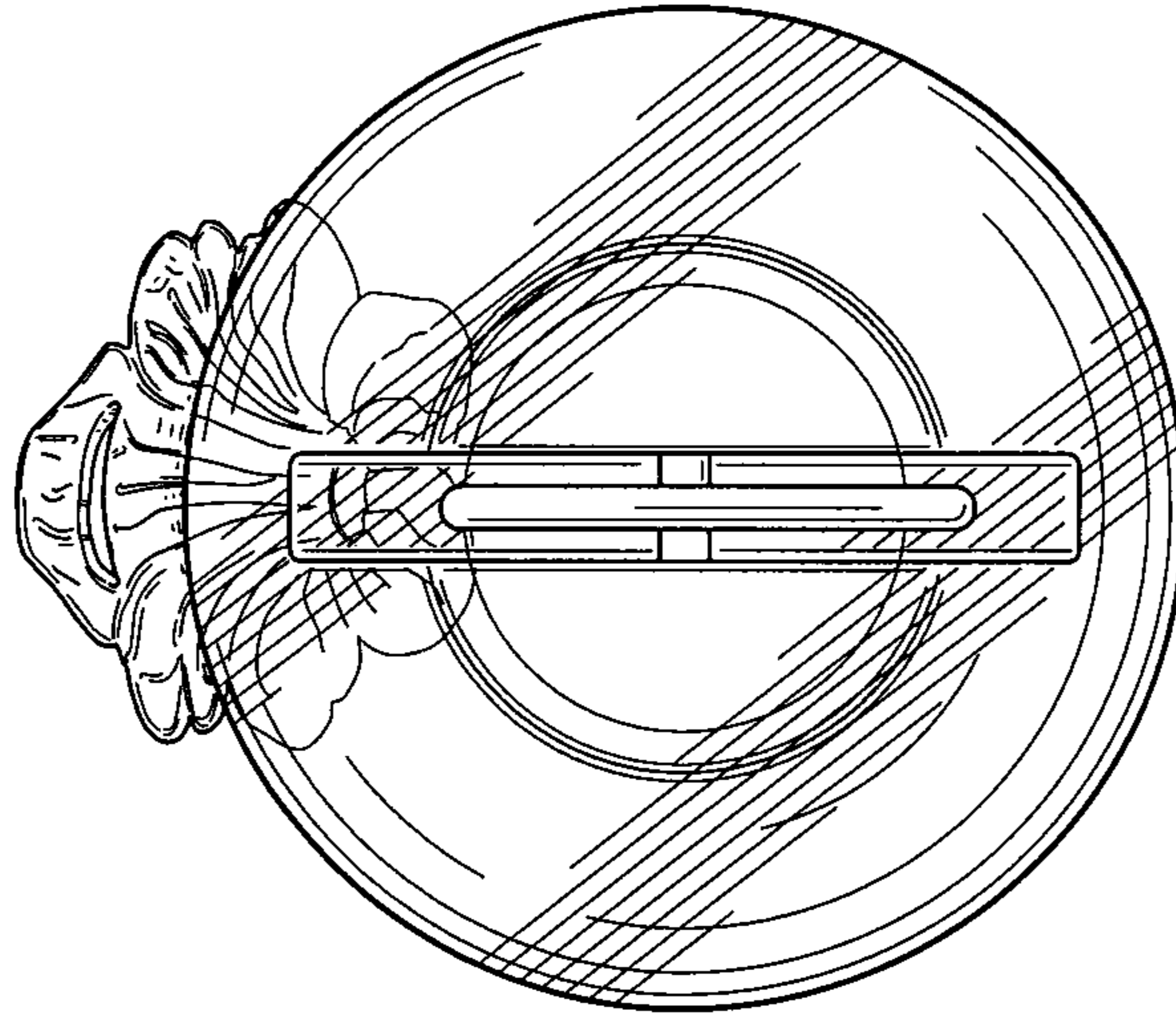

FIG. 6

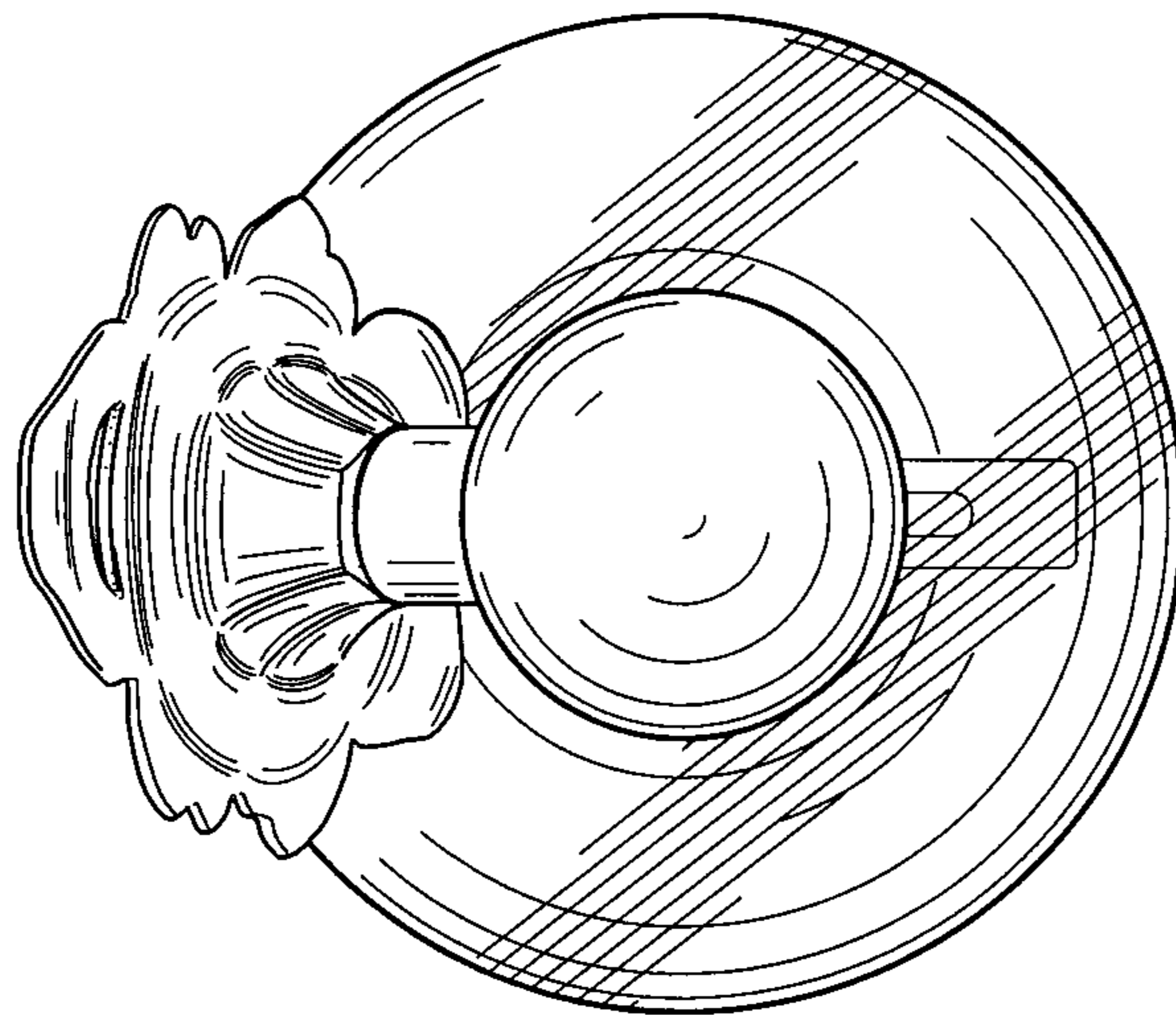

FIG. 7