

US00D698034S

(12) **United States Design Patent**
Gladieux, III

(10) **Patent No.:** **US D698,034 S**
(45) **Date of Patent:** **** Jan. 21, 2014**

(54) **MESSAGE TOOL APPLICATOR HOLDER**

(71) Applicant: **Bernard L. Gladieux, III**, Boyertown, PA (US)

(72) Inventor: **Bernard L. Gladieux, III**, Boyertown, PA (US)

(73) Assignee: **The Pressure Positive Company**, Gilbertsville, PA (US)

(**) Term: **14 Years**

(21) Appl. No.: **29/458,965**

(22) Filed: **Jun. 25, 2013**

(51) **LOC (10) Cl.** **28-03**

(52) **U.S. Cl.**
USPC **D24/215**

(58) **Field of Classification Search**
USPC D24/200, 211, 212, 213, 214, 215;
601/114, 120, 121, 124, 125, 130, 131,
601/134, 135, 136, 137
See application file for complete search history.

(56) **References Cited**

U.S. PATENT DOCUMENTS

D185,246	S	*	5/1959	Taran	D24/211
4,002,164	A	*	1/1977	Bradley	601/135
4,266,536	A	*	5/1981	Casares	601/119
4,798,198	A	*	1/1989	Wright	601/119
D326,525	S	*	5/1992	Shimizu	D24/214
D402,764	S	*	12/1998	Chatfield	D24/211
D403,431	S	*	12/1998	Gladieux, Jr.	D24/215

5,862,564	A	*	1/1999	Hamm	15/210.1
6,261,251	B1	*	7/2001	Meyers	601/135
D461,009	S	*	7/2002	Viner	D24/214
6,758,826	B2	*	7/2004	Luetngen et al.	601/73
7,122,015	B2	*	10/2006	Luetngen et al.	601/73
D539,915	S	*	4/2007	Timmer	D24/214
7,335,171	B2	*	2/2008	Ewell et al.	601/15
D646,794	S	*	10/2011	Hennessey	D24/214
2003/0009116	A1	*	1/2003	Luetngen et al.	601/46
2005/0015028	A1	*	1/2005	Luetngen et al.	601/95
2007/0239086	A1	*	10/2007	Ewell et al.	601/15
2011/0224588	A1	*	9/2011	Grippio	601/135

* cited by examiner

Primary Examiner — Sandra Snapp

(74) *Attorney, Agent, or Firm* — Clark & Brody

(57) **CLAIM**

The ornamental design for a massage tool applicator holder, as shown and described.

DESCRIPTION

FIG. 1 is a right side elevation view of a massage tool applicator holder showing my new design.
FIG. 2 is a top plan view thereof.
FIG. 3 is a front elevation view thereof.
FIG. 4 is a rear elevation view thereof.
FIG. 5 is a left side elevation view thereof.
FIG. 6 is a bottom view thereof; and,
FIG. 7 is a left side elevation view thereof showing the environment in phantom lines.
The broken lines shown in the drawings are for illustrative purposes only and form no part of the claimed design.

1 Claim, 4 Drawing Sheets

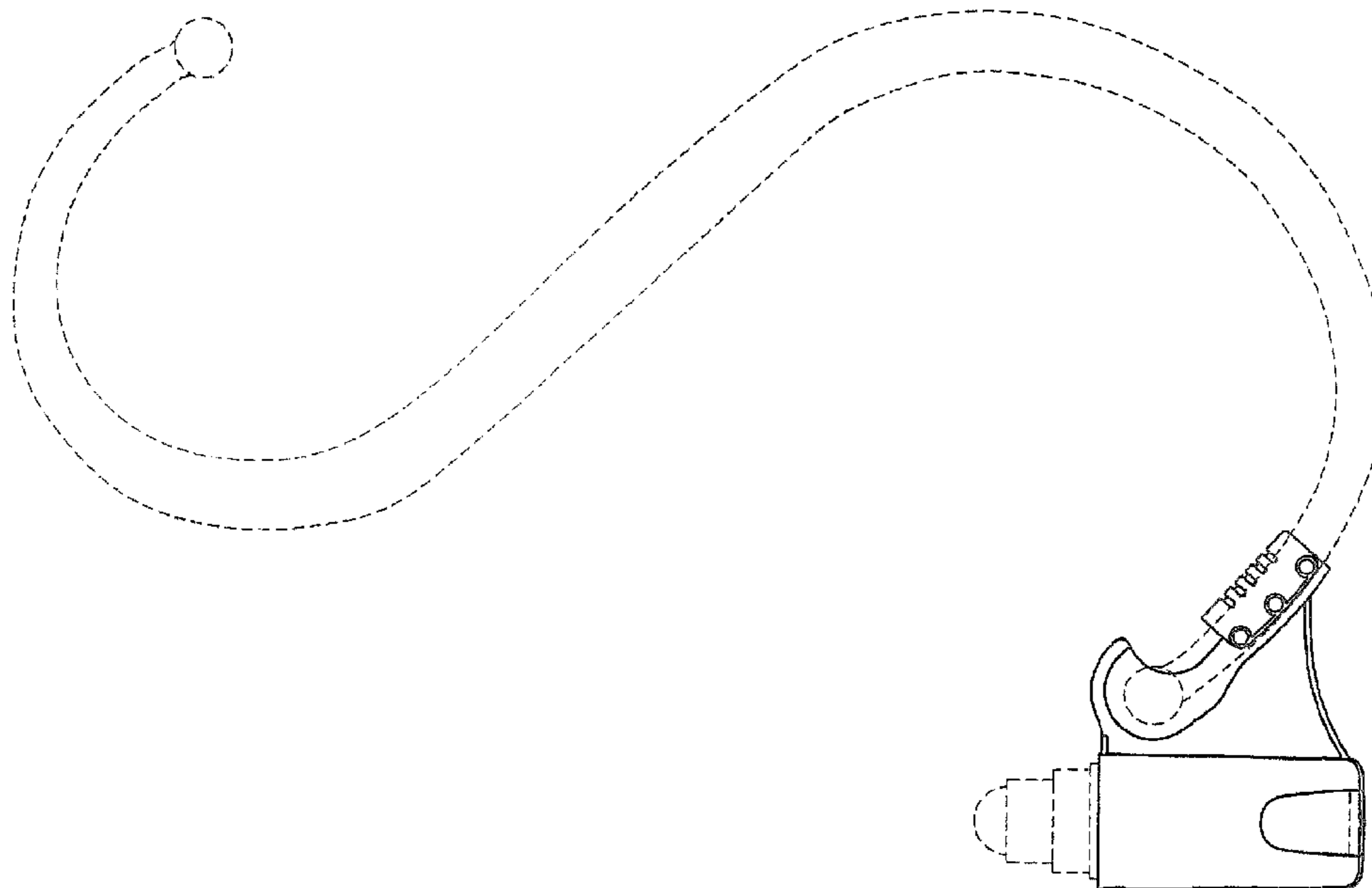

FIG. 1

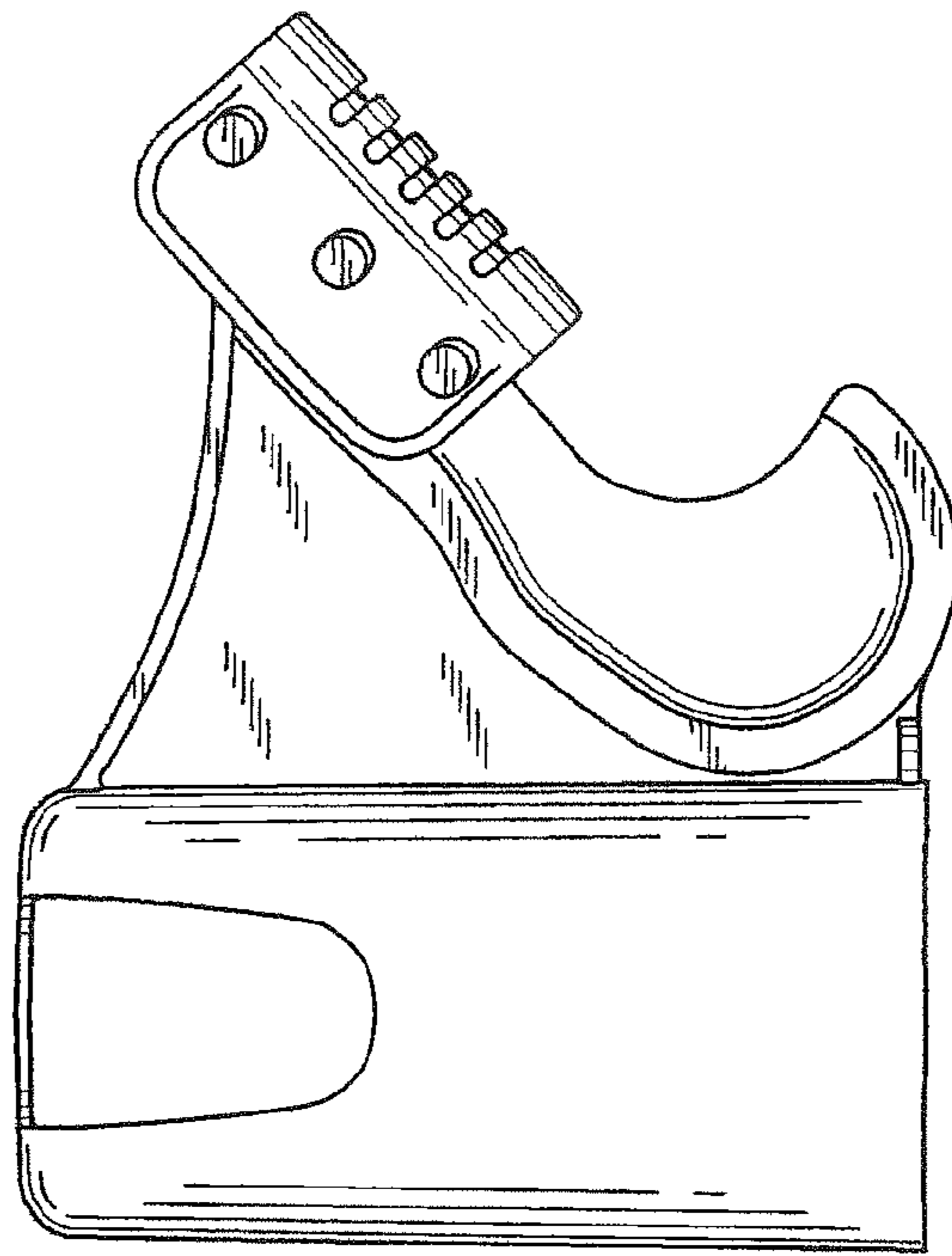

FIG. 2

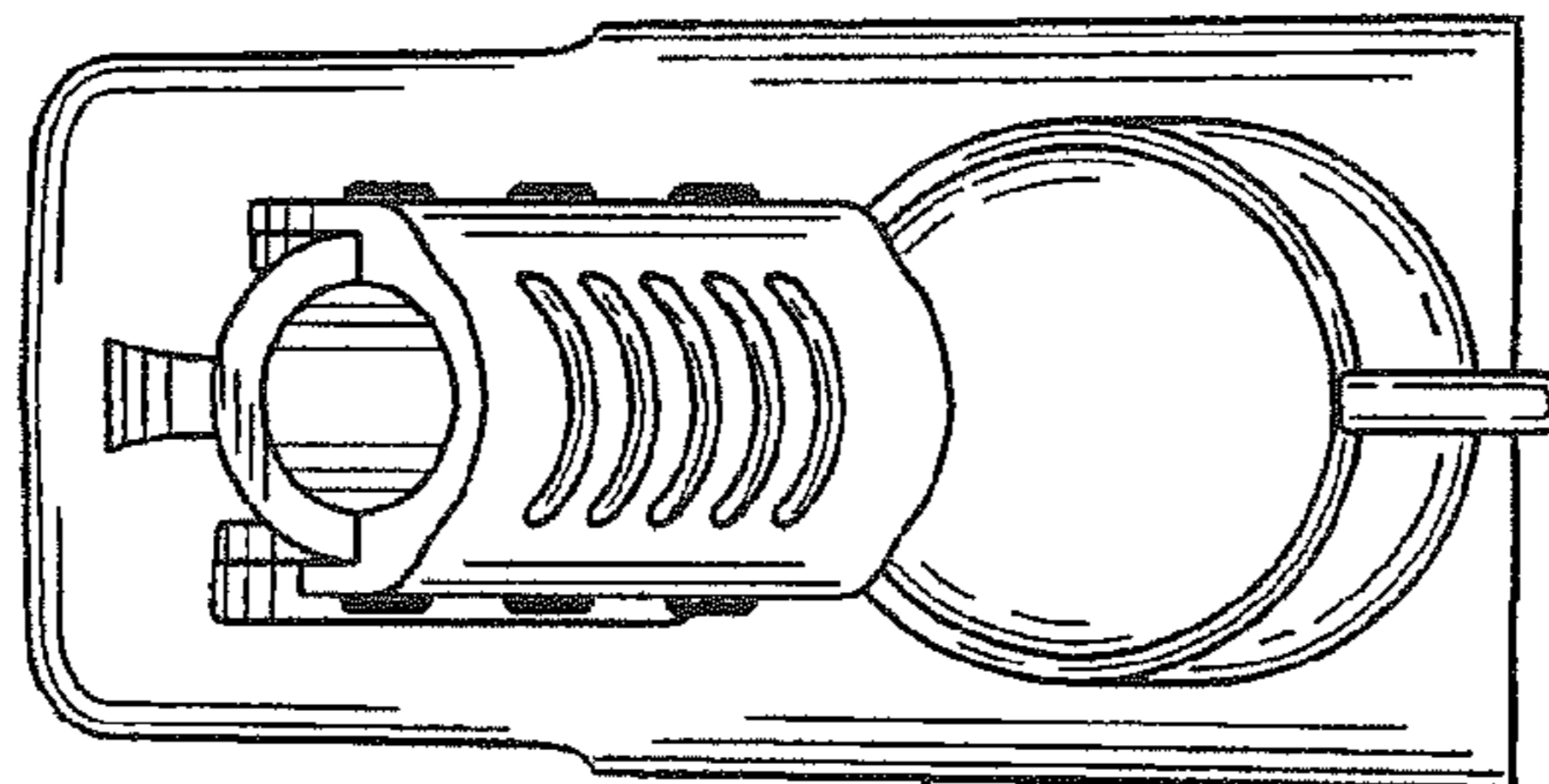

FIG. 3

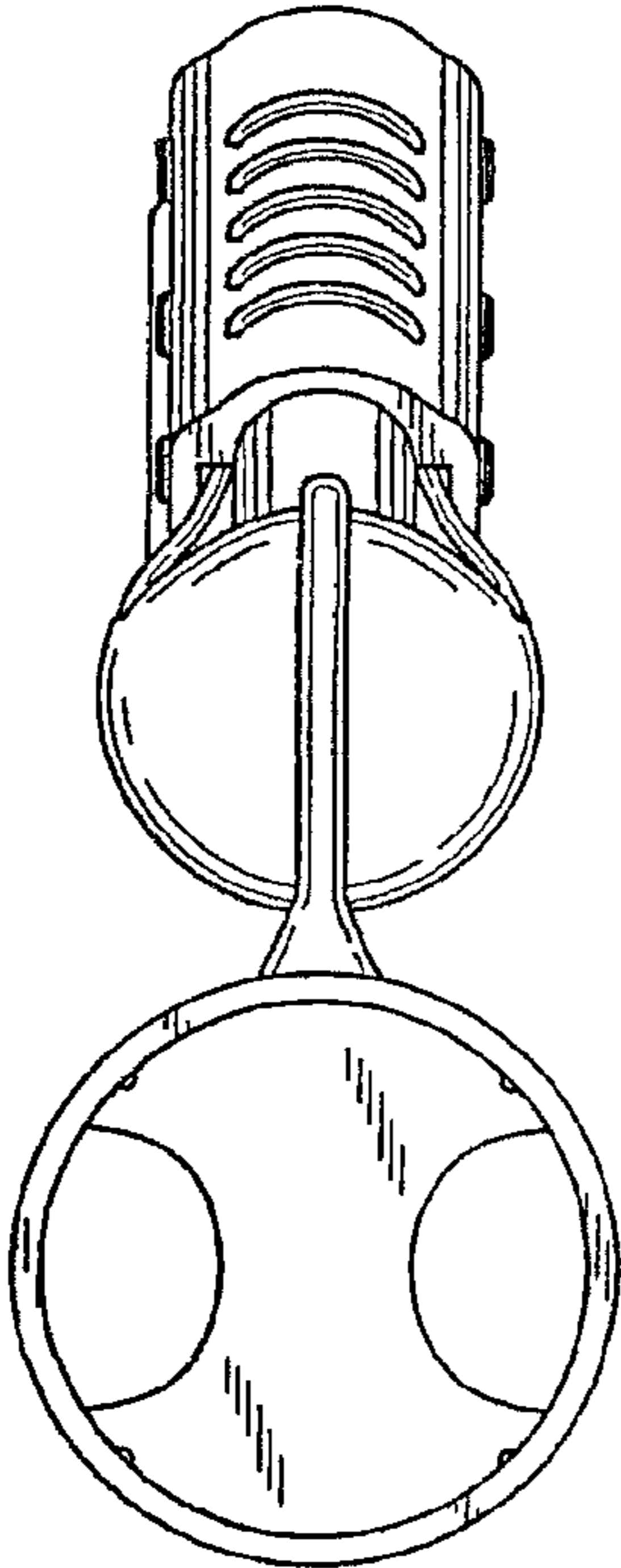

FIG. 4

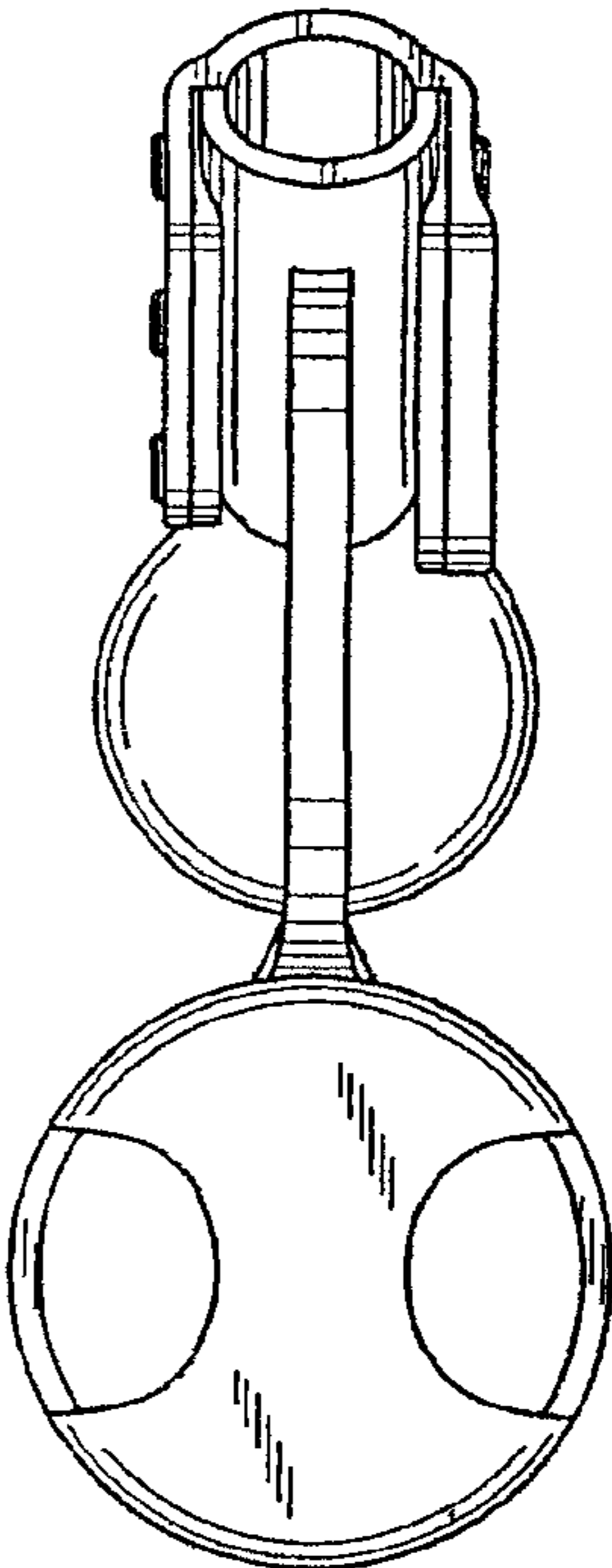

FIG. 5

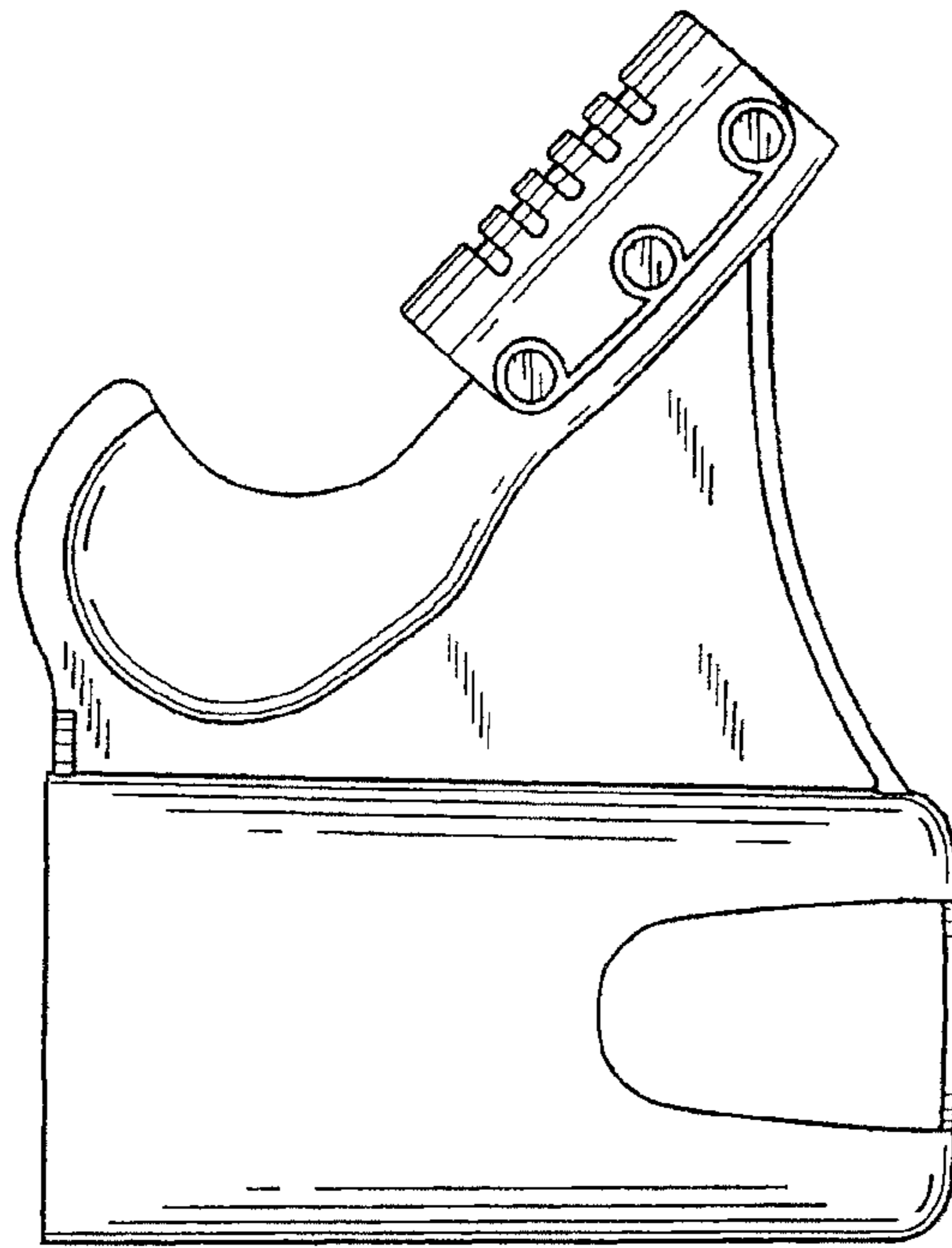

FIG. 6

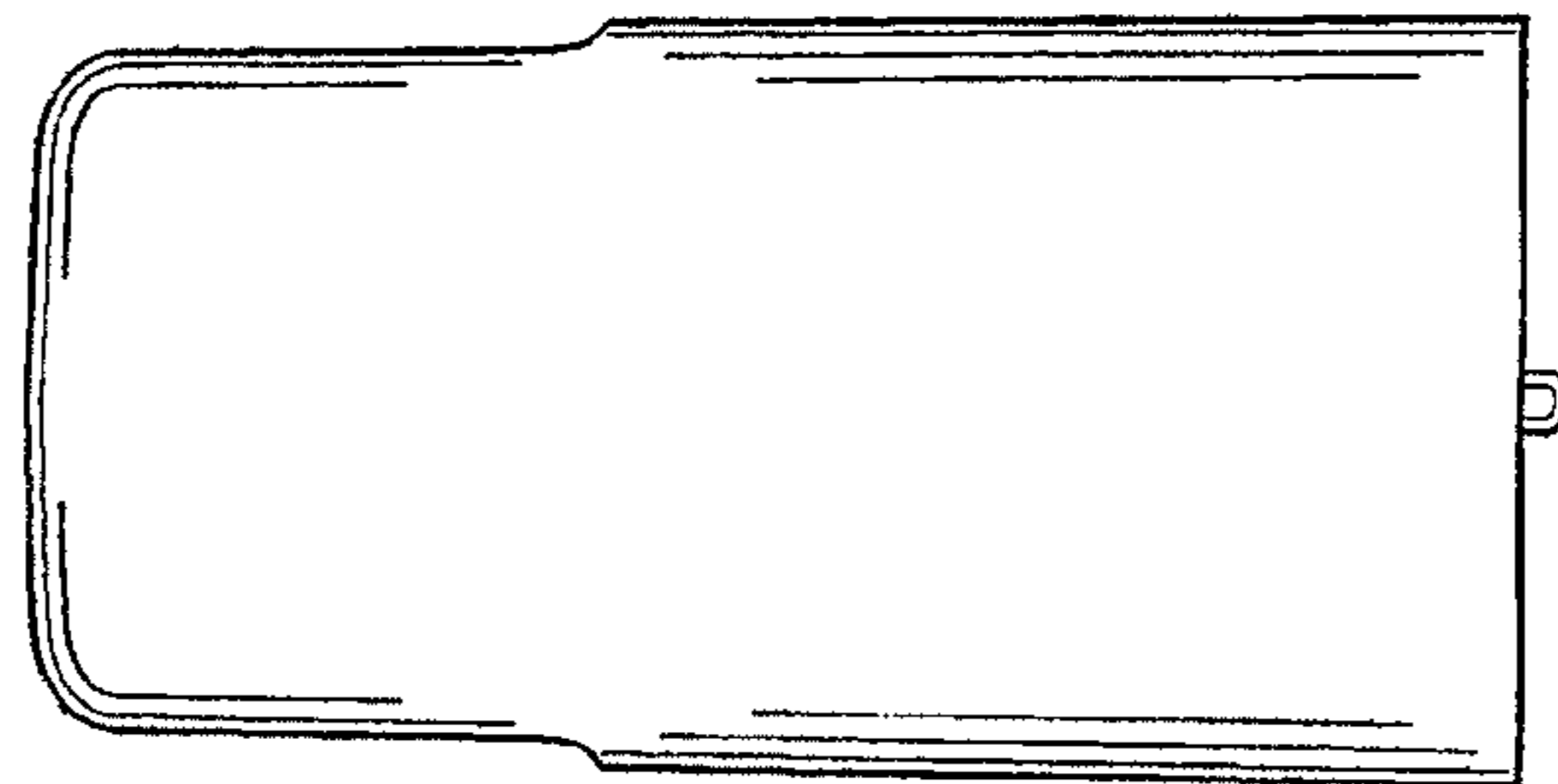

FIG. 7

