



US00D697909S

(12) **United States Design Patent**  
**Zhao et al.**

(10) **Patent No.:** **US D697,909 S**  
(45) **Date of Patent:** **\*\* Jan. 21, 2014**

(54) **NOTEBOOK COMPUTER**

(75) Inventors: **Yidan Zhao**, Shanghai (CN);  
**Donghwan Zhao**, Shanghai (CN); **Li Li**,  
Shanghai (CN); **Zhenqi Tang**, Shanghai  
(CN)

(73) Assignee: **Samsung (China) Investment Co., Ltd.**  
(CN)

(\*\*) Term: **14 Years**

(21) Appl. No.: **29/427,561**

(22) Filed: **Jul. 19, 2012**

(30) **Foreign Application Priority Data**

Jan. 19, 2012 (CN) ..... 2012 3 0016307

(51) **LOC (10) Cl.** ..... **14-02**

(52) **U.S. Cl.**  
USPC ..... **D14/318**

(58) **Field of Classification Search**  
USPC ..... D14/315-327; D18/1, 2, 7, 11;  
235/145 A, 145 R; 341/22, 23; 345/104,  
345/156, 168, 169, 173; 361/679.08,  
361/679.09, 679.11, 679.26, 679.27

See application file for complete search history.

(56) **References Cited**

**U.S. PATENT DOCUMENTS**

6,067,224 A \* 5/2000 Nobuchi ..... 361/679.27  
D517,063 S \* 3/2006 Nakajima et al. .... D14/318  
D604,291 S \* 11/2009 Andre et al. .... D14/315  
D605,192 S \* 12/2009 Lin ..... D14/315  
D607,449 S \* 1/2010 Morisawa ..... D14/318

D615,969 S \* 5/2010 Arbisi et al. .... D14/327  
D643,032 S \* 8/2011 Heck et al. .... D14/315  
2005/0041378 A1 \* 2/2005 Hamada et al. .... 361/680

\* cited by examiner

*Primary Examiner* — Freda S Nunn

(74) *Attorney, Agent, or Firm* — Brooks Kushman P.C.

(57) **CLAIM**

The ornamental design for a notebook computer, as shown and described.

**DESCRIPTION**

FIG. 1 is a front elevational view of an embodiment of our notebook computer;

FIG. 2 is a rear elevational view thereof;

FIG. 3 is a right side elevational view thereof;

FIG. 4 is a left side elevational view thereof;

FIG. 5 is a bottom plan view thereof;

FIG. 6 is a top plan view thereof;

FIG. 7 is a right side elevational view of the notebook computer of FIG. 2 with the screen in the raised position;

FIG. 8 is a top plan view of the notebook computer of FIG. 6 with the screen in the raised position;

FIG. 9 is a top plan view of a second embodiment of our notebook computer with the screen in the raised position;

FIG. 10 is a perspective view of the notebook computer of FIG. 9;

FIG. 11 is a front side elevational view of the notebook computer of FIG. 9 with the screen in the closed position; and,

FIG. 12 is a top plan view of the notebook computer of FIG. 9 with the screen in the closed position.

The portions of the computer shown in broken lines form no part of the claimed design.

**1 Claim, 5 Drawing Sheets**

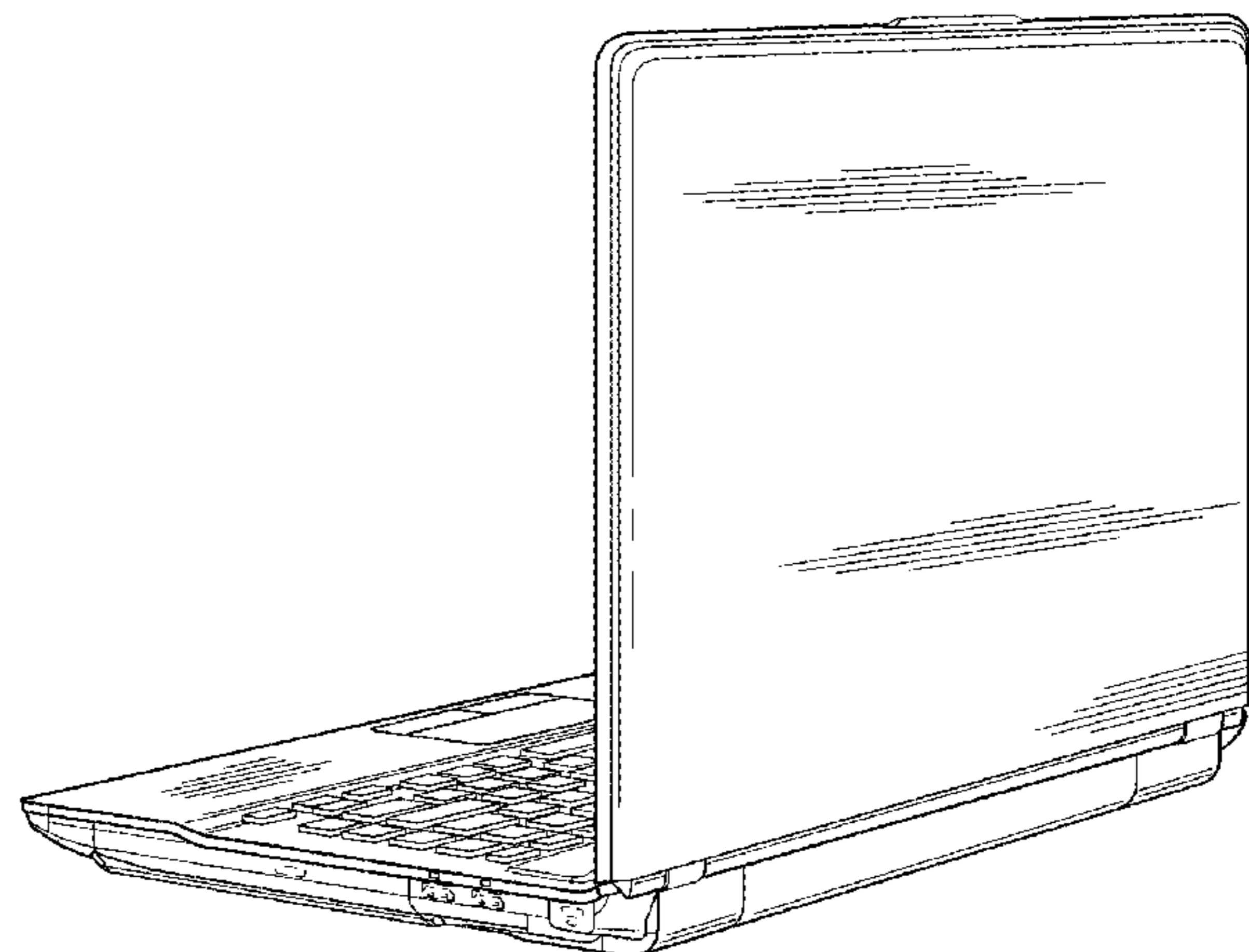
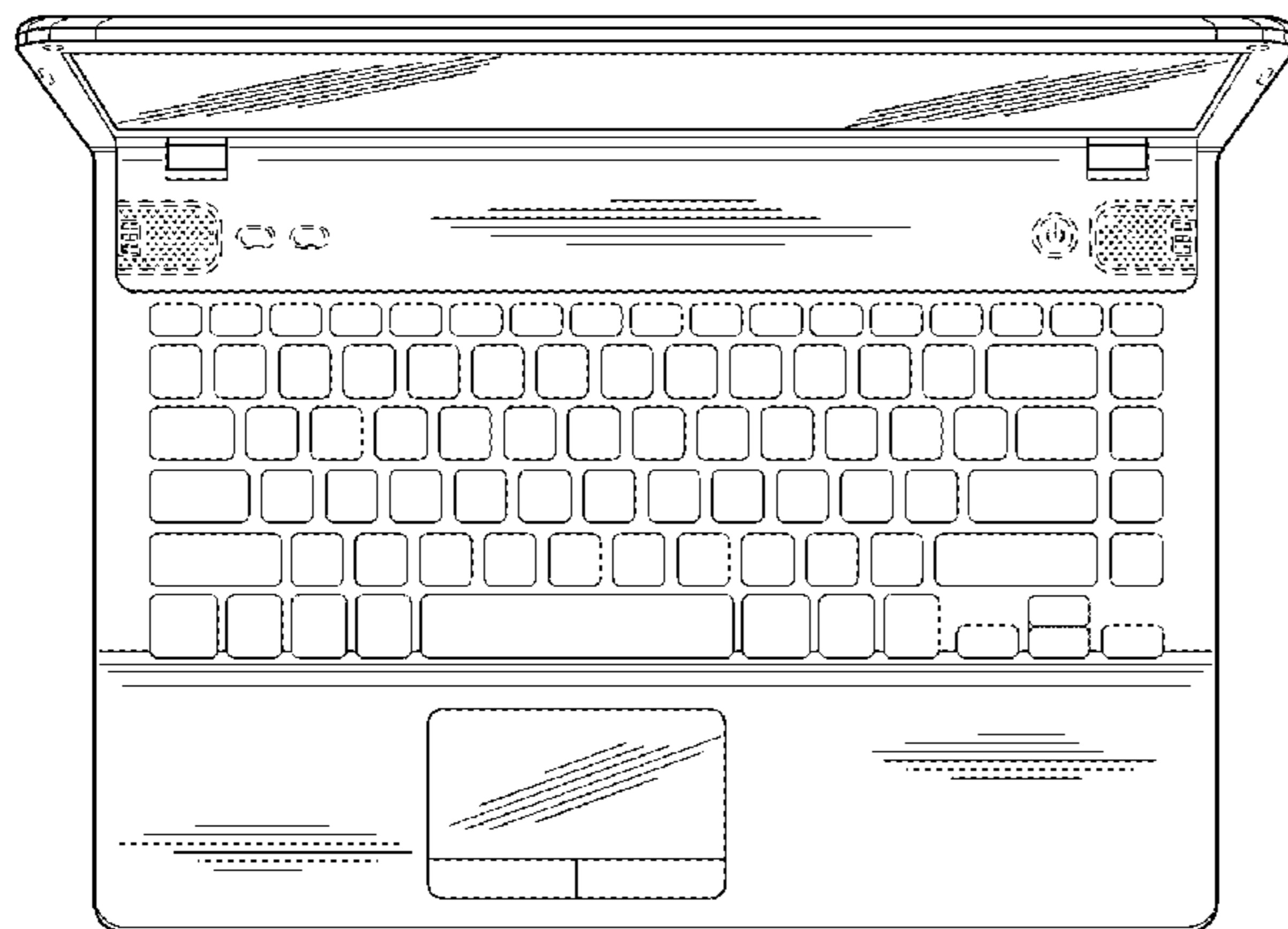

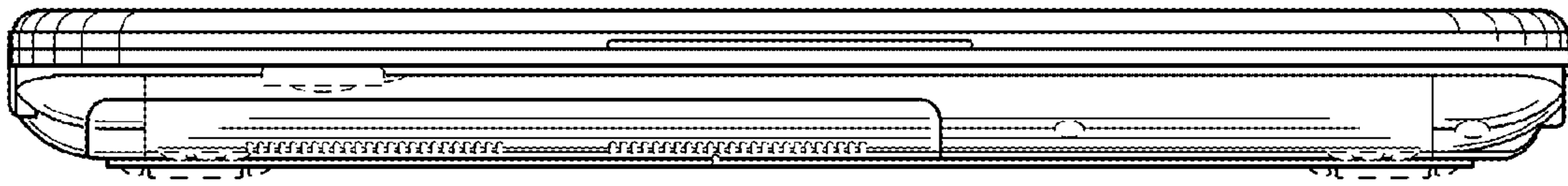

FIG. 1

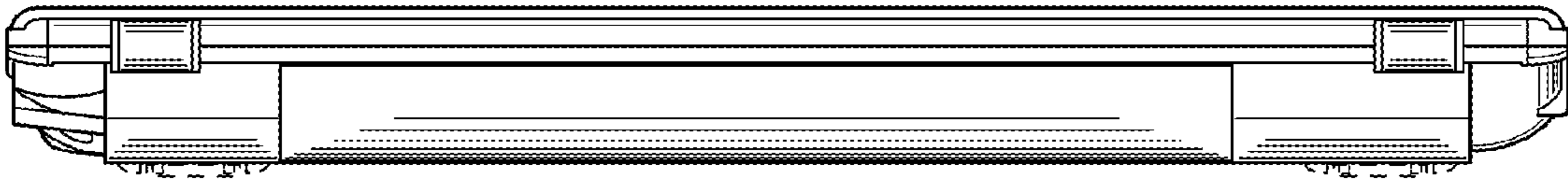

FIG. 2

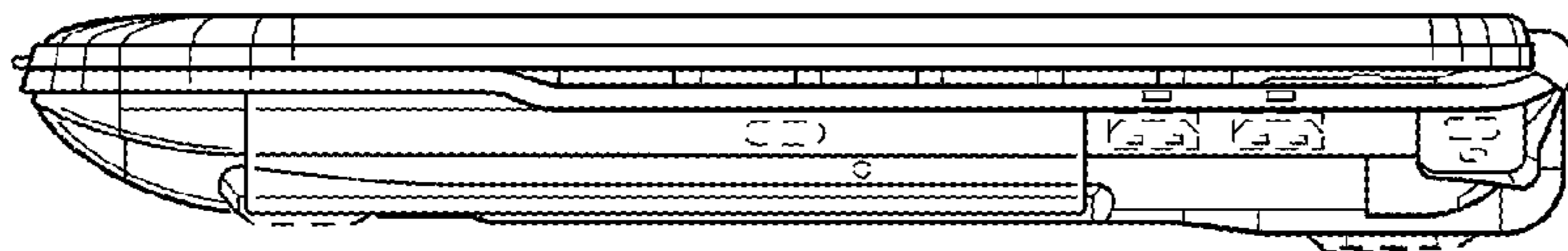

FIG. 3

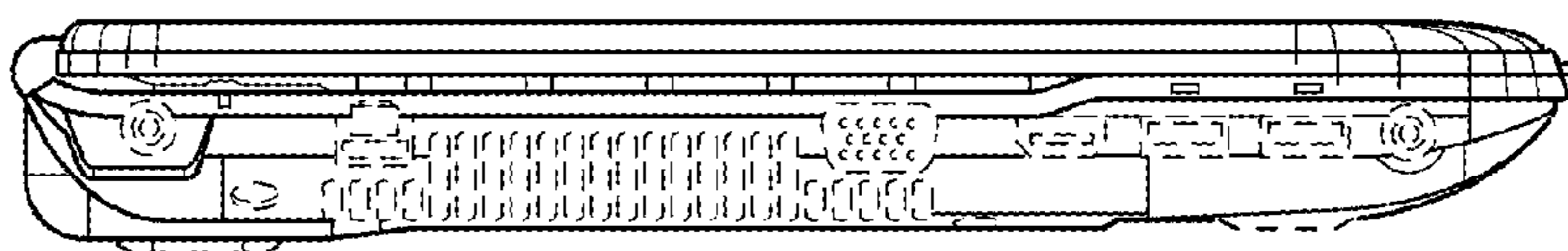

FIG. 4

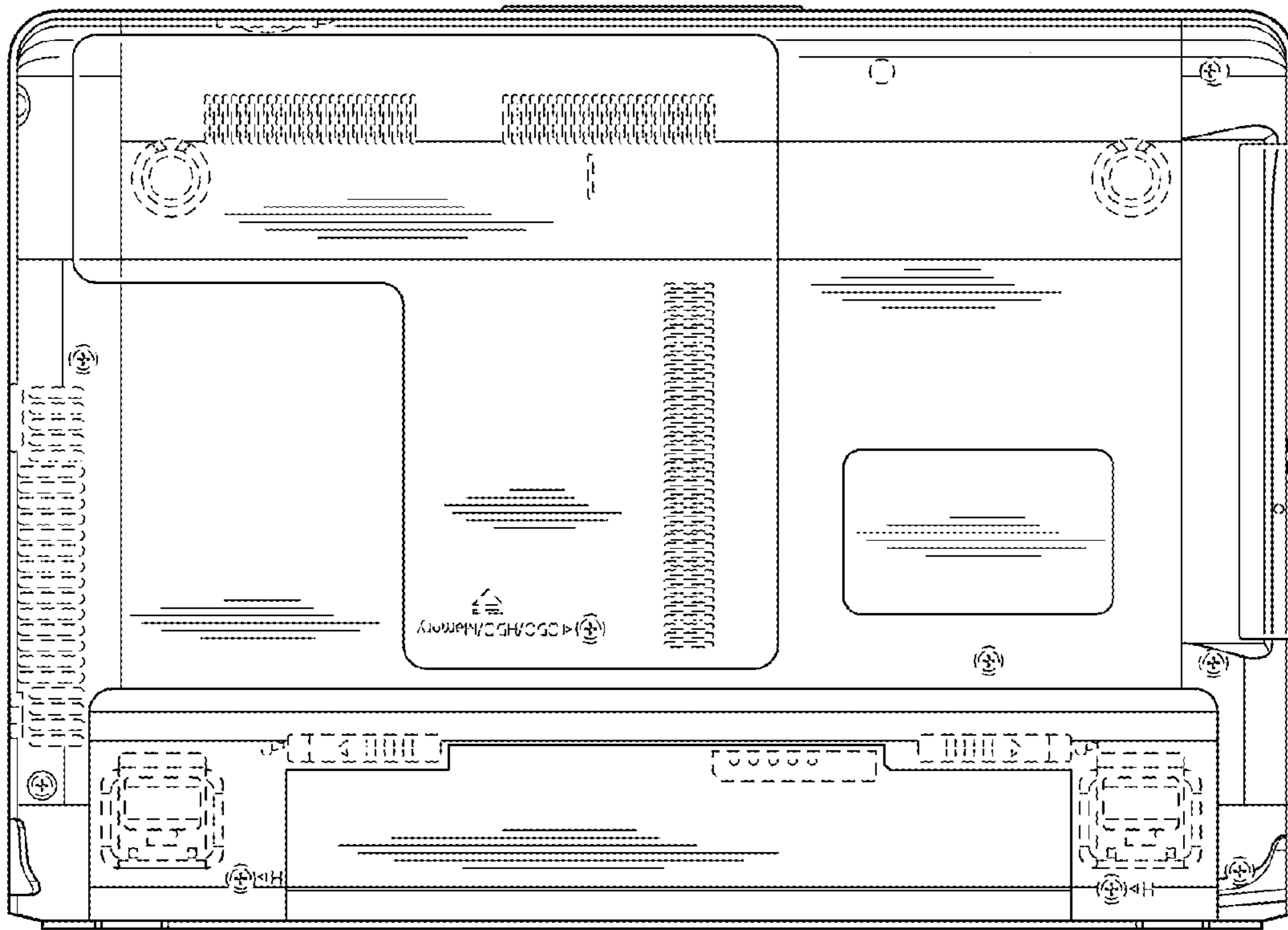

FIG. 5



FIG. 6

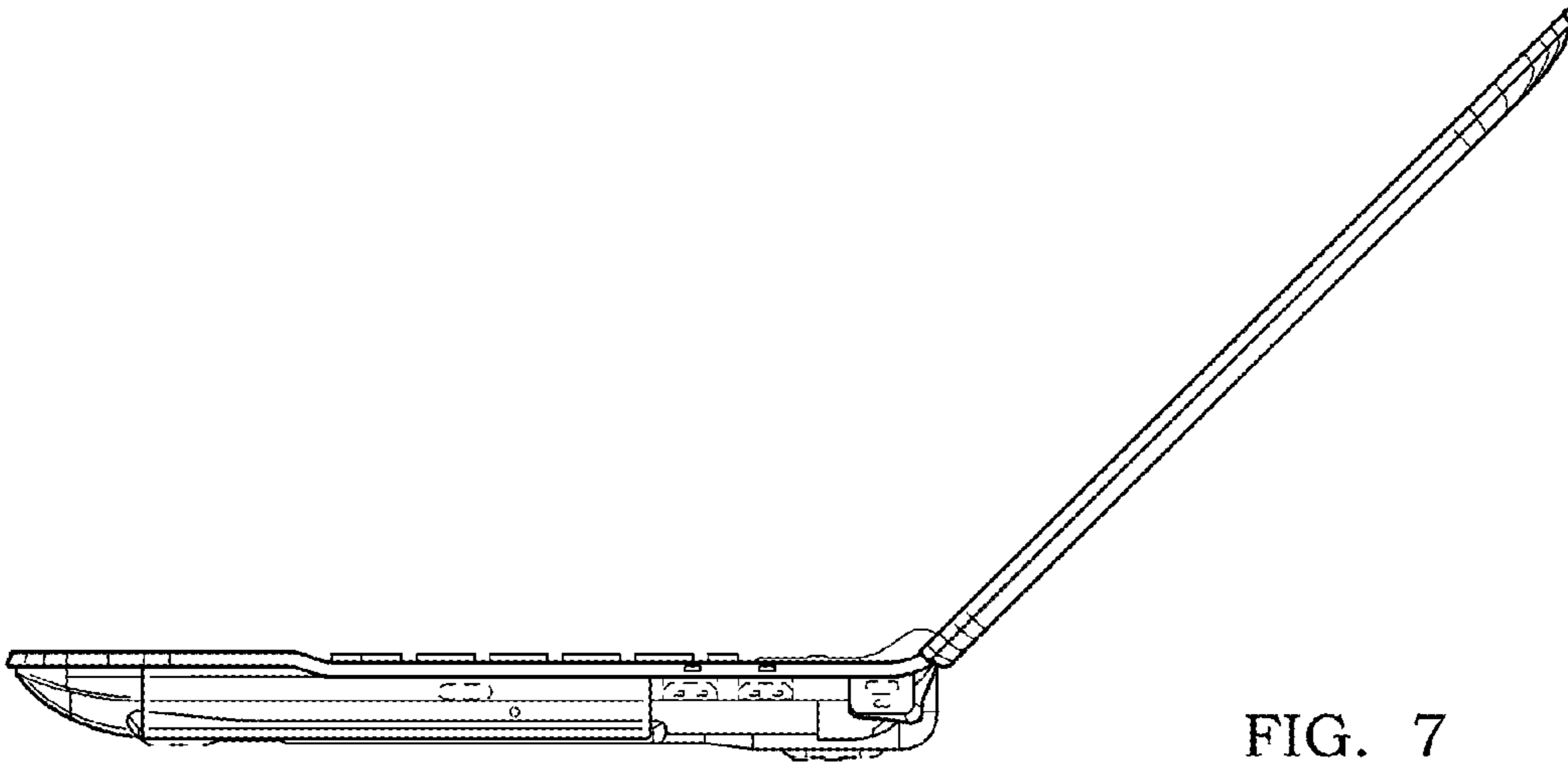

FIG. 7

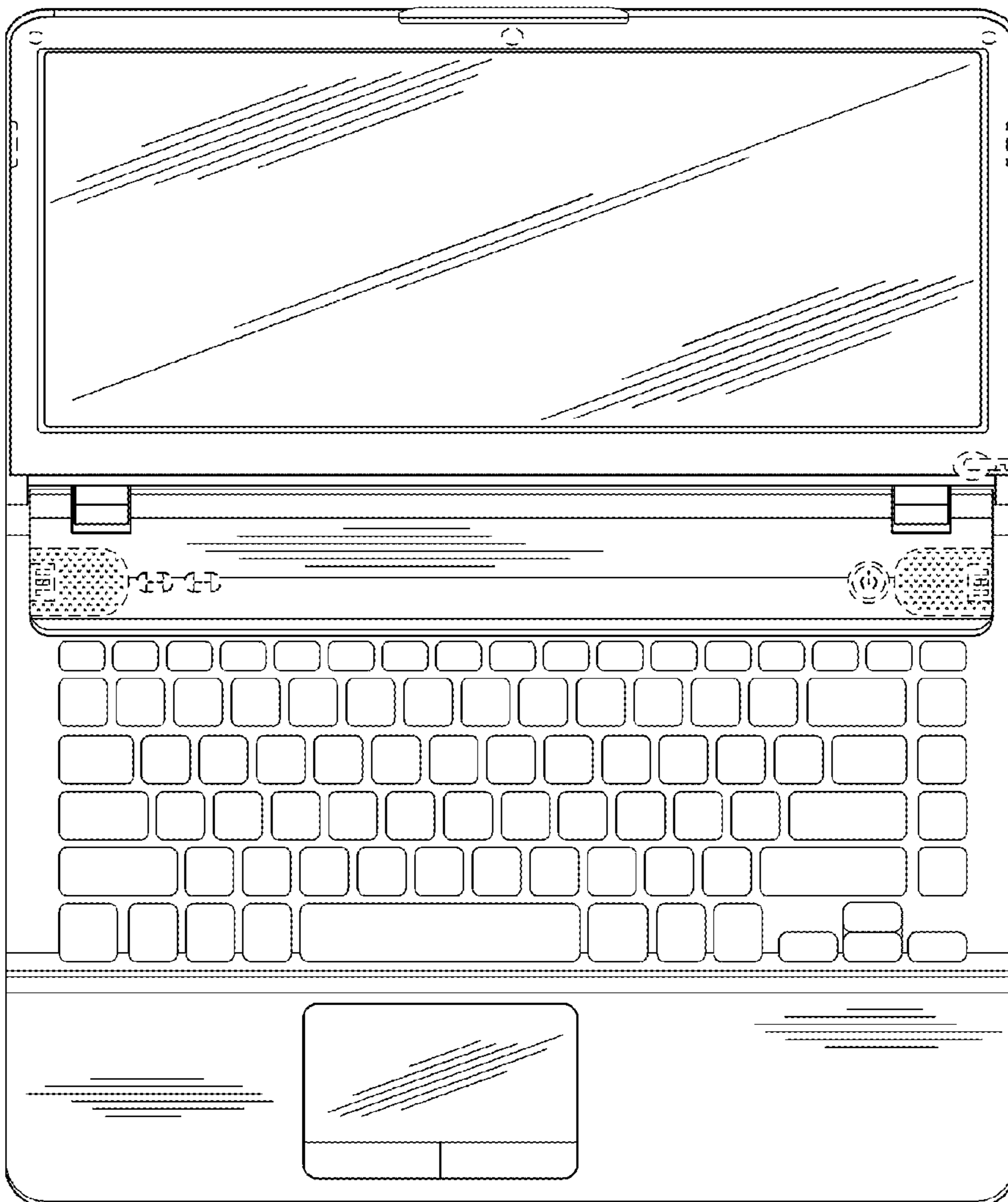

FIG. 8

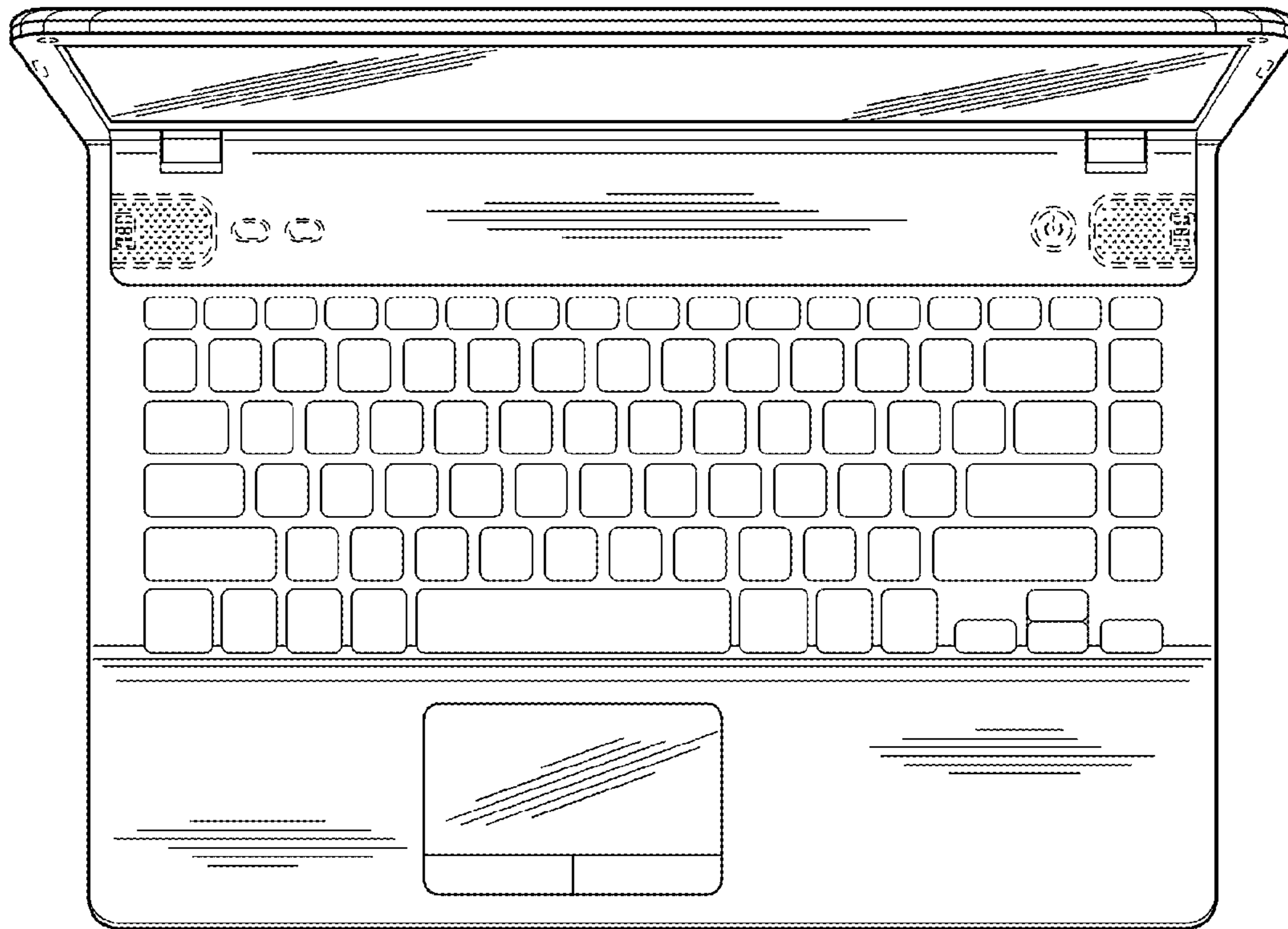

FIG. 9

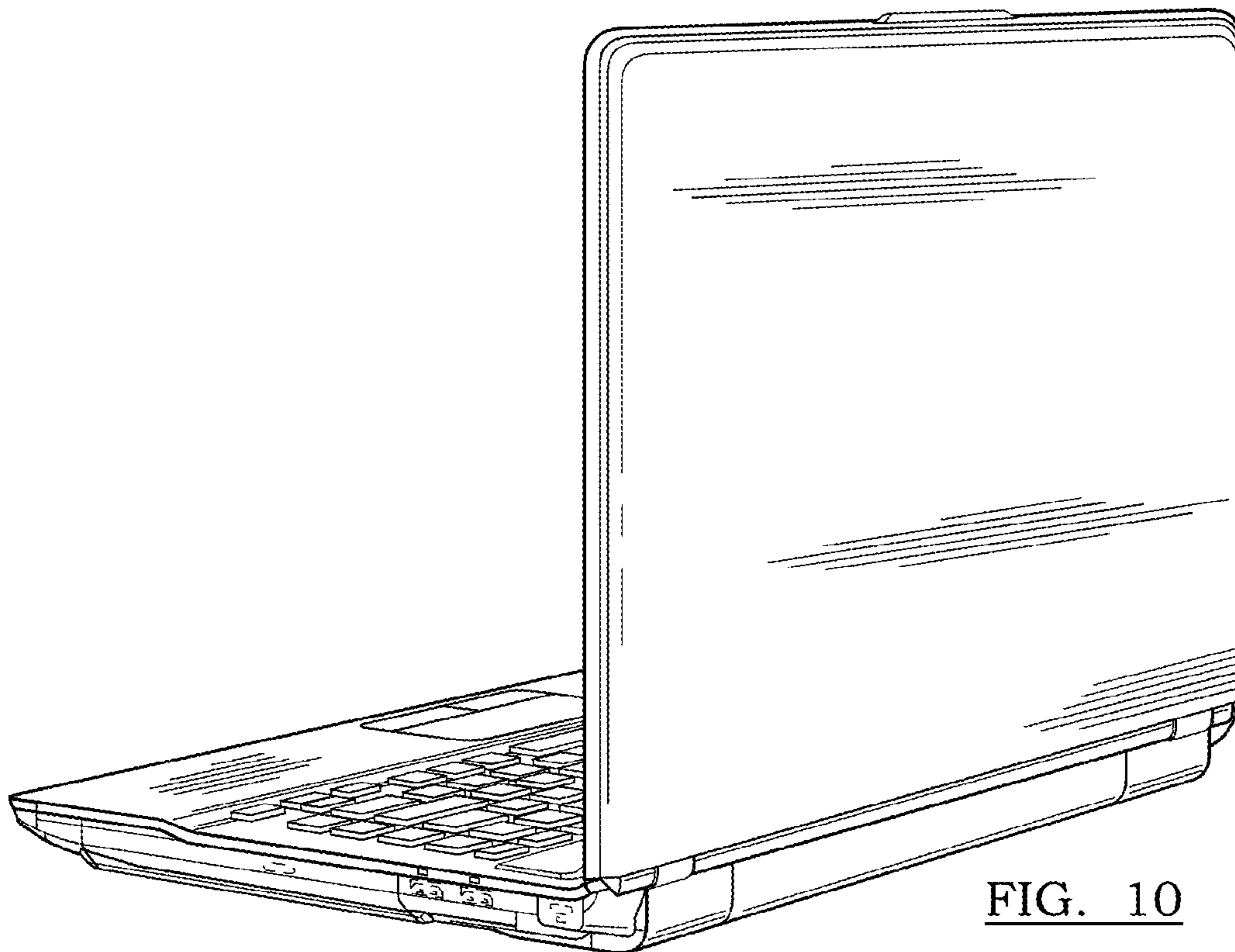

FIG. 10

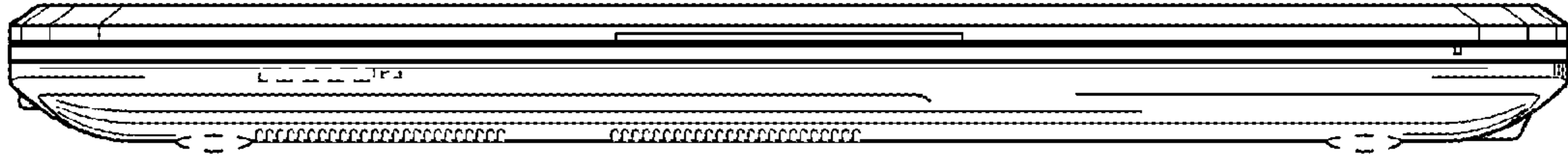

FIG. 11



FIG. 12

UNITED STATES PATENT AND TRADEMARK OFFICE  
**CERTIFICATE OF CORRECTION**

PATENT NO. : D697,909 S  
APPLICATION NO. : 29/427561  
DATED : January 21, 2014  
INVENTOR(S) : Yidan Zhao et al.

Page 1 of 1

It is certified that error appears in the above-identified patent and that said Letters Patent is hereby corrected as shown below:

On the Title Page

Item (75) Inventors:

Delete the name of the second inventor "Donghwan Zhao" and

Insert --Donghwan Yang--

Signed and Sealed this  
Fifteenth Day of July, 2014



Michelle K. Lee  
*Deputy Director of the United States Patent and Trademark Office*