



US00D697902S

(12) **United States Design Patent**
Fathollahi

(10) **Patent No.:** **US D697,902 S**
(45) **Date of Patent:** **** Jan. 21, 2014**

- (54) **CASE**
- (71) Applicant: **Incipio Technologies, Inc.**, Irvine, CA (US)
- (72) Inventor: **Andy Fathollahi**, Corona Del Mar, CA (US)
- (73) Assignee: **Incipio Technologies, Inc.**, Irvine, CA (US)
- (**) Term: **14 Years**
- (21) Appl. No.: **29/453,499**
- (22) Filed: **Apr. 30, 2013**

- 5,386,098 A 1/1995 Knudsen
- D371,137 S 6/1996 Kriegh
- D387,199 S 12/1997 Nagele et al.
- D389,641 S 1/1998 McCutcheon et al.
- D392,097 S 3/1998 Pottala et al.
- 5,755,367 A 5/1998 Yamada

(Continued)

FOREIGN PATENT DOCUMENTS

WO DM/058570 11/2001

OTHER PUBLICATIONS

Incipio Silicrylic for iPhone 3G, on sale more than one year prior to filing date, product as shown on Amazon.com product page, <http://www.amazon.com/Incipio-SILICRYLIC-Case-iPhone-Clear/dp/B001AV8OD8>, retrieved on Oct. 29, 2012.

(Continued)

Primary Examiner — Susan Bennett Hattan
Assistant Examiner — Vy Koenig
(74) *Attorney, Agent, or Firm* — Dickstein Shapiro LLP

Related U.S. Application Data

- (63) Continuation of application No. 29/385,458, filed on Feb. 14, 2011, now Pat. No. Des. 681,615.
 - (51) **LOC (10) Cl.** **14-03**
 - (52) **U.S. Cl.**
USPC **D14/250**
 - (58) **Field of Classification Search**
USPC D14/248, 250–253, 440, 203.1–203.7, D14/217–218, 496, 137–138 AA, 138 G, D14/168, 474; D3/201, 218, 269, 301, 273, D3/303, 103, 247; D13/103, 107, 108, D13/119; D6/407; D21/333; 220/4.02; 361/679.56, 679.55, 679.01; 379/426, 379/433.11, 455; 455/575.1, 575.8; 190/100; 206/305, 320
- See application file for complete search history.

- (57) **CLAIM**
The ornamental design for a case, as shown and described.

DESCRIPTION

FIG. 1 is a top end view of a case.
FIG. 2 is a bottom end view thereof.
FIG. 3 is a left side view thereof.
FIG. 4 is a right side view thereof.
FIG. 5 is a front view thereof.
FIG. 6 is a rear view thereof; and,
FIG. 7 is a rear perspective view thereof.
The broken lines immediately adjacent the shaded surfaces represent boundaries of the claimed design and all unshaded surfaces within these broken lines form no part of the claimed design. All other broken lines depict environmental features that form no part of the claimed design.

1 Claim, 7 Drawing Sheets

- (56) **References Cited**
U.S. PATENT DOCUMENTS
- | | | |
|------------|---------|------------------|
| D287,905 S | 1/1987 | Oyamada |
| D320,992 S | 10/1991 | Jondelius |
| D337,435 S | 7/1993 | Kaneko et al. |
| D339,690 S | 9/1993 | Takahashi et al. |
| D346,275 S | 4/1994 | Hayasaka et al. |

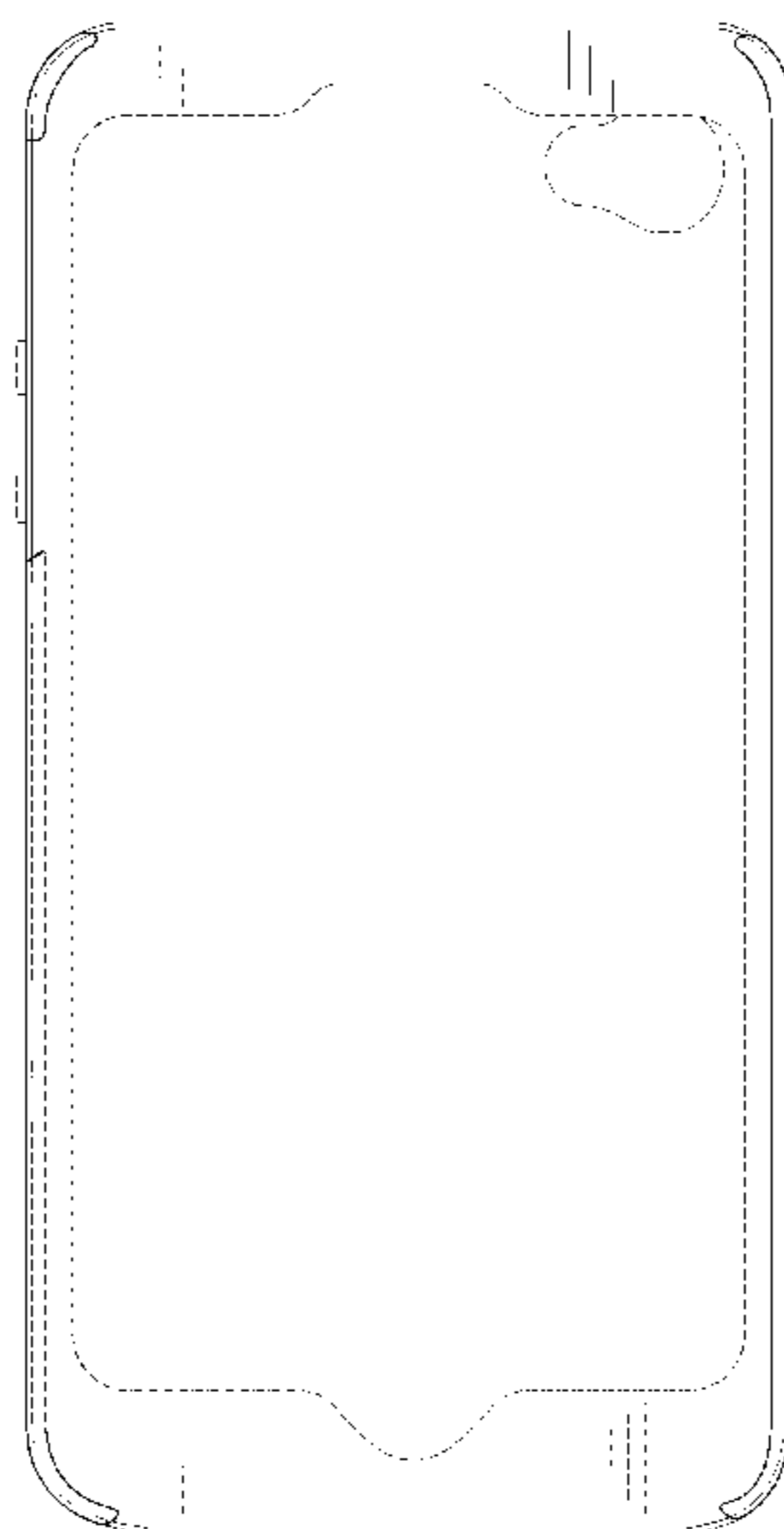

(56)

References Cited

U.S. PATENT DOCUMENTS

D400,209 S 10/1998 Williams et al.
 D406,191 S 3/1999 Phillips et al.
 5,992,343 A 11/1999 Drover
 D419,290 S 1/2000 Treyer et al.
 6,124,783 A 9/2000 Alexander
 D434,898 S 12/2000 Jokinen et al.
 D462,514 S 9/2002 Rivera et al.
 D466,287 S 12/2002 Tanaka
 D469,438 S 1/2003 Corrales
 D495,871 S 9/2004 Moffitt et al.
 D499,546 S 12/2004 Smithers
 6,954,047 B2 10/2005 Neubauer
 D521,232 S 5/2006 Andre et al.
 7,097,233 B2 8/2006 Sogame et al.
 D529,713 S 10/2006 Guyot et al.
 D543,541 S 5/2007 Chung et al.
 D553,352 S 10/2007 Allen
 D561,204 S 2/2008 Toh
 D565,290 S 4/2008 Brandenburg et al.
 D578,129 S 10/2008 Weber
 D587,896 S 3/2009 Aipa
 7,542,052 B2 6/2009 Solomon et al.
 D609,226 S 2/2010 Hofer et al.
 D609,464 S 2/2010 Bullen
 D616,430 S 5/2010 Fathollahi
 D620,931 S 8/2010 Opman
 D628,994 S 12/2010 Griffin et al.
 D632,686 S 2/2011 Magness et al.
 D635,555 S 4/2011 Giles
 D640,679 S 6/2011 Willes et al.
 D643,836 S 8/2011 Smith et al.
 D644,635 S 9/2011 Richardson et al.
 D645,441 S 9/2011 Choe et al.
 8,016,107 B2 9/2011 Emsky
 D646,266 S 10/2011 Kim et al.
 D646,671 S 10/2011 Fathollahi
 D646,673 S 10/2011 Fathollahi

D647,518 S 10/2011 Fathollahi
 D647,895 S 11/2011 Fathollahi
 D648,301 S 11/2011 Zuffo et al.
 D651,201 S 12/2011 Fathollahi
 D652,031 S 1/2012 Fahrendorff et al.
 D654,069 S 2/2012 Kwon et al.
 8,132,670 B1 3/2012 Chen
 D659,139 S 5/2012 Gengler
 D662,503 S 6/2012 Akana et al.
 D663,263 S 7/2012 Gupta et al.
 D665,735 S 8/2012 Kang et al.
 D665,762 S 8/2012 Fujimura et al.
 D665,809 S 8/2012 Wang et al.
 8,245,843 B1 8/2012 Wu
 D676,845 S * 2/2013 Melanson et al. D14/250
 D679,694 S * 4/2013 Fahrendorff et al. D14/250
 D679,695 S * 4/2013 Fahrendorff et al. D14/250
 D681,615 S 5/2013 Fathollahi
 D681,624 S * 5/2013 Chang D14/250
 D684,567 S * 6/2013 Murchison et al. D14/250
 2003/0151890 A1 8/2003 Huang et al.
 2004/0112776 A1 6/2004 Lord
 2005/0242941 A1 11/2005 Chao
 2006/0231713 A1 10/2006 Crain et al.
 2008/0012383 A1 1/2008 Larson
 2008/0251512 A1 10/2008 Griffin et al.
 2010/0051712 A1 3/2010 Lebeck
 2010/0096284 A1 4/2010 Bau
 2010/0147737 A1 6/2010 Richardson et al.
 2010/0289390 A1 11/2010 Kenney

OTHER PUBLICATIONS

Incipio Silicrylic 2007, on sale more than one year prior to filing date.
 Otterbox Commuter Series Case for BlackBerry Storm, as shown at
 URL: <http://youtu.be/7ZxkbUSwjIQ>, uploaded Oct. 1, 2009.
 iPhone 4 4S Silicrylic Dualpro Hard Shell, <https://www.incipio.com/index.php/cases/iphone-cases/iphone-4-4-silicrylic>, retrieved online
 Sep. 17, 2012.

* cited by examiner

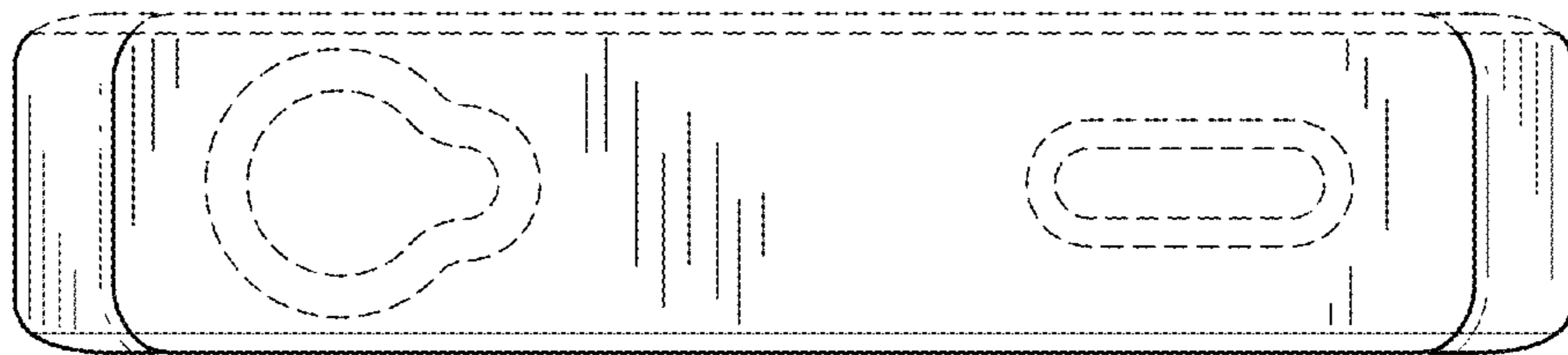

FIG. 1

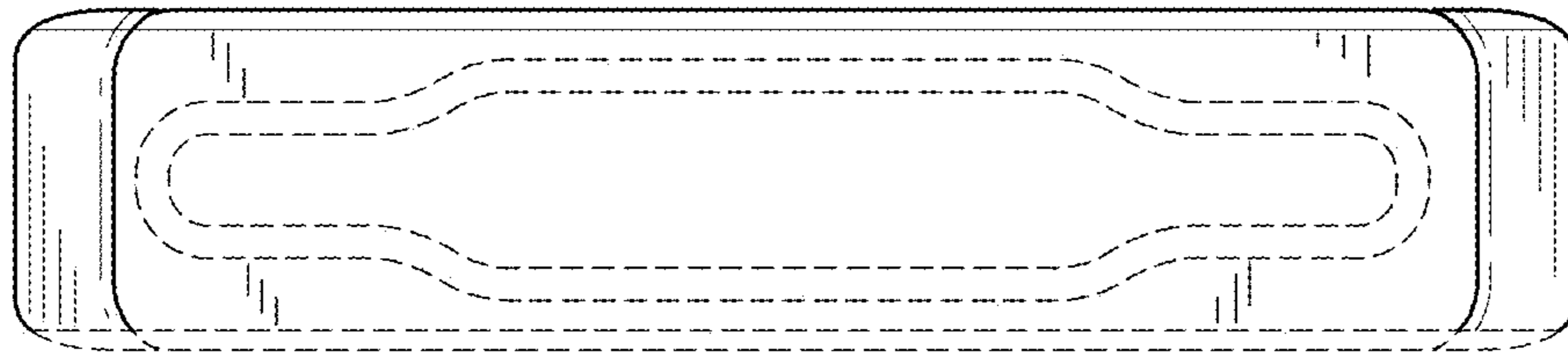

FIG. 2

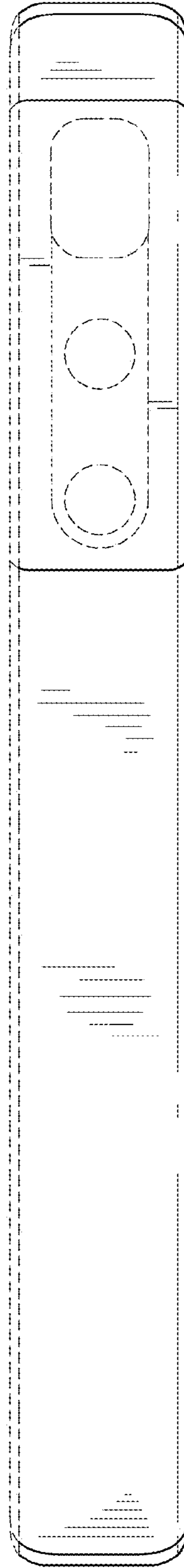

FIG. 3

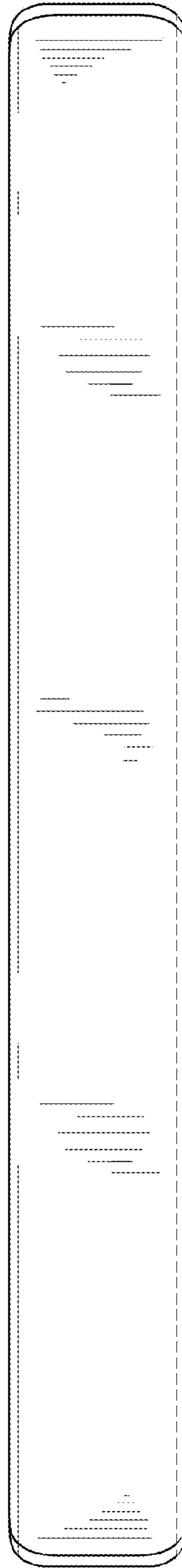

FIG. 4

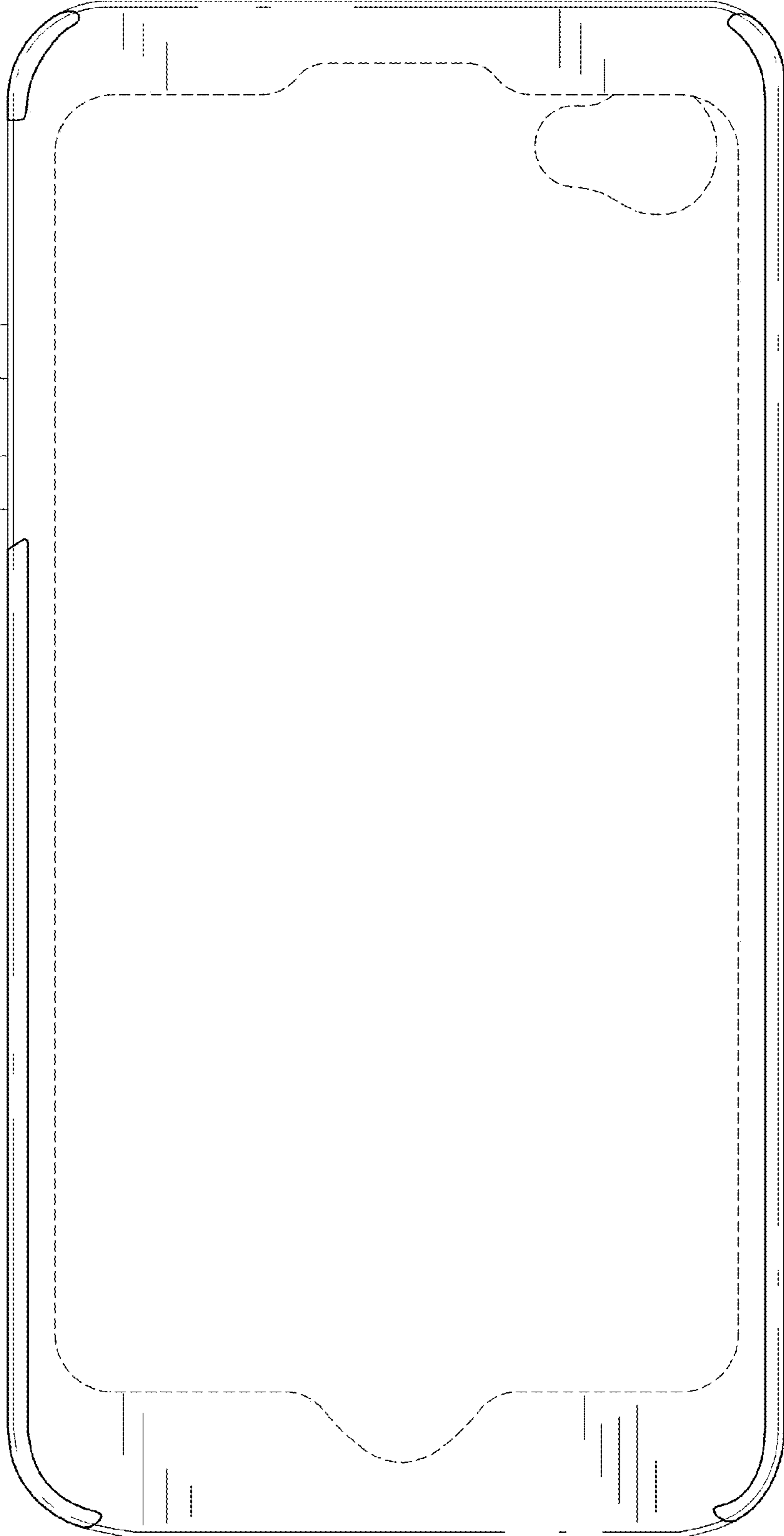

FIG. 5

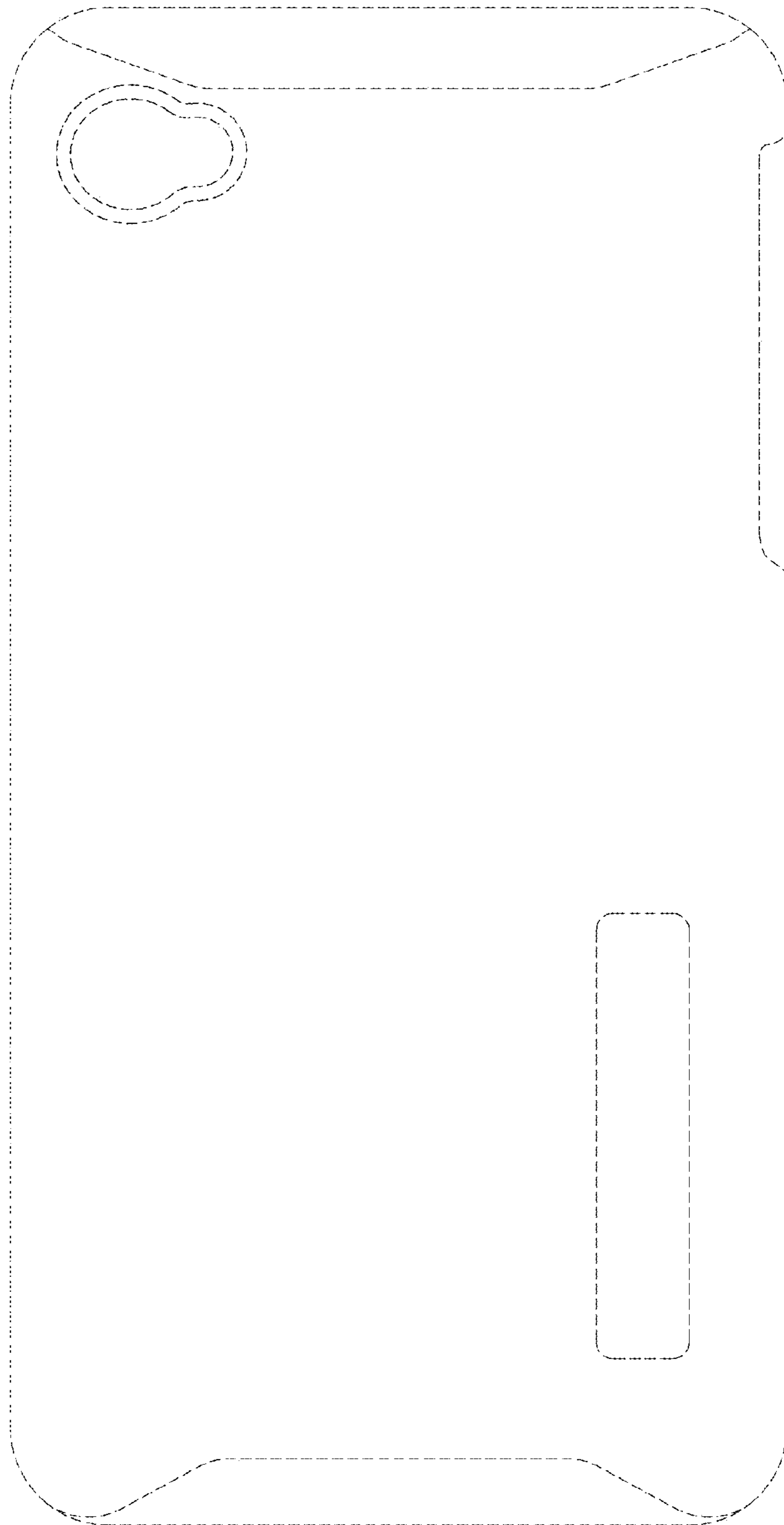

FIG. 6

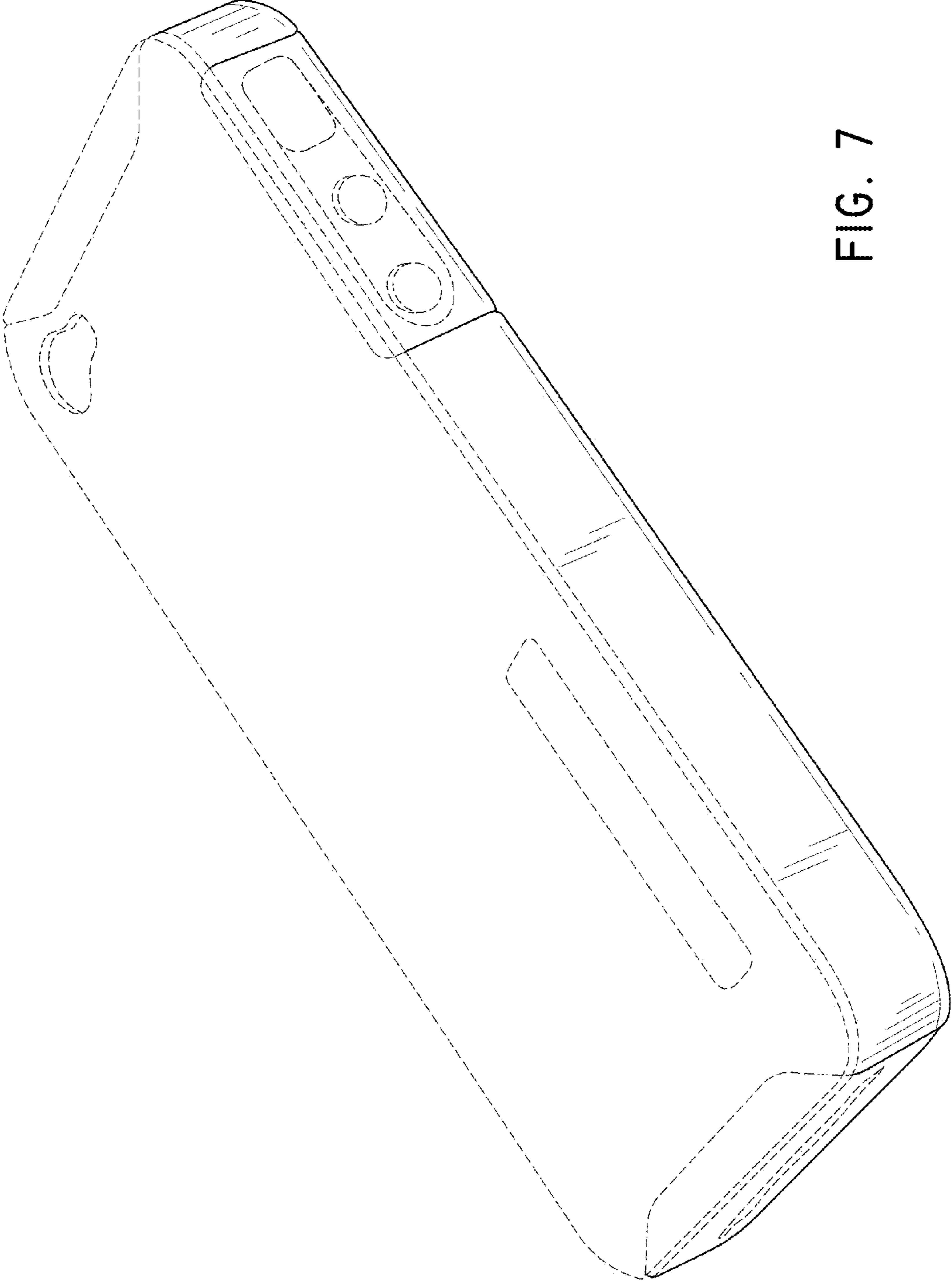

FIG. 7