



US00D697857S

(12) **United States Design Patent**
Kingsbury et al.

(10) **Patent No.:** **US D697,857 S**

(45) **Date of Patent:** **** Jan. 21, 2014**

(54) **AUTOMOTIVE FLOOR MAT SET**

(71) Applicant: **Hopkins Manufacturing Corporation**,
Emporia, KS (US)

(72) Inventors: **James R. Kingsbury**, Lakewood, CA
(US); **Pieter Schouten**, Berkeley, CA
(US)

(73) Assignee: **Hopkins Manufacturing Corporation**,
Emporia, KS (US)

(**) Term: **14 Years**

(21) Appl. No.: **29/444,301**

(22) Filed: **Jan. 29, 2013**

(51) **LOC (10) Cl.** **12-16**

(52) **U.S. Cl.**
USPC **D12/203**

(58) **Field of Classification Search**
USPC D12/203; D6/582-586, 592-594;
280/163-164.1; 15/215-217;
428/138.141; 296/97.23

See application file for complete search history.

(56) **References Cited**

U.S. PATENT DOCUMENTS

D178,980 S	*	10/1956	Barnes	D12/203
D393,238 S	*	4/1998	Kraines	D12/203
D468,676 S	*	1/2003	Takahashi et al.	D12/203
D514,044 S	*	1/2006	Hussaini et al.	D12/203
D537,025 S	*	2/2007	Kraines	D12/203

D550,137 S	*	9/2007	Kraines	D12/203
D569,318 S	*	5/2008	Kraines	D12/203
D647,446 S	*	10/2011	Jeackjuntra et al.	D12/203
D659,623 S	*	5/2012	Lu	D12/203

* cited by examiner

Primary Examiner — Stacia Cadmus

(74) *Attorney, Agent, or Firm* — George R. McGuire; Bond
Schoeneck & King, PLLC

(57) **CLAIM**

The ornamental design for an automotive floor mat set, as shown and described.

DESCRIPTION

FIG. 1 is a perspective view of a front left floor mat for an automobile;
 FIG. 2 is a top plan view thereof;
 FIG. 3 is a first side elevation view thereof;
 FIG. 4 is a second side elevation view thereof;
 FIG. 5 is a front elevation view thereof;
 FIG. 6 is a rear elevation view thereof;
 FIG. 7 is a perspective view of a front right floor mat for an automobile;
 FIG. 8 is a top plan view thereof;
 FIG. 9 is a first side elevation view thereof;
 FIG. 10 is a second side elevation view thereof;
 FIG. 11 is a front elevation view thereof; and,
 FIG. 12 is a rear elevation view thereof.

1 Claim, 8 Drawing Sheets

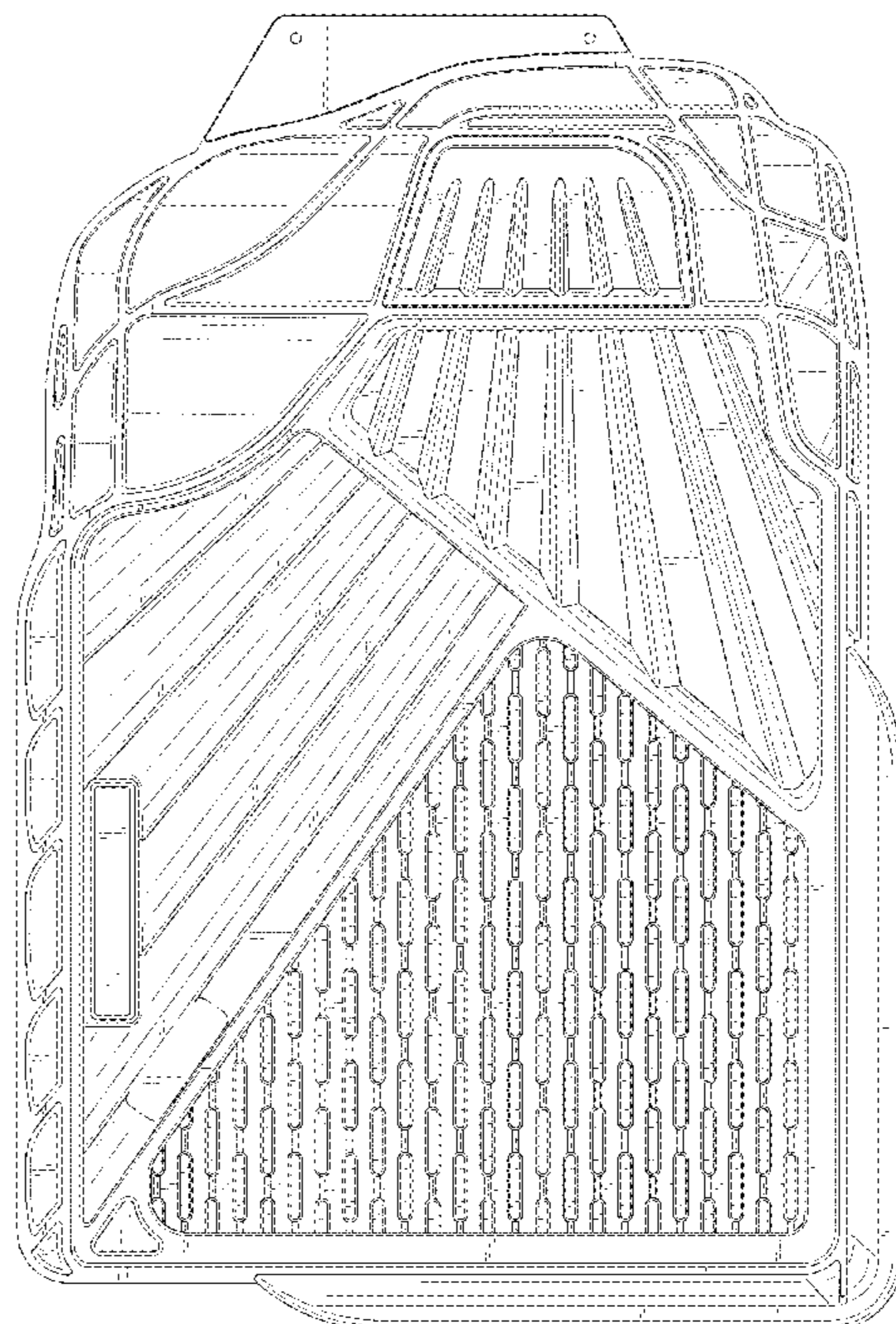
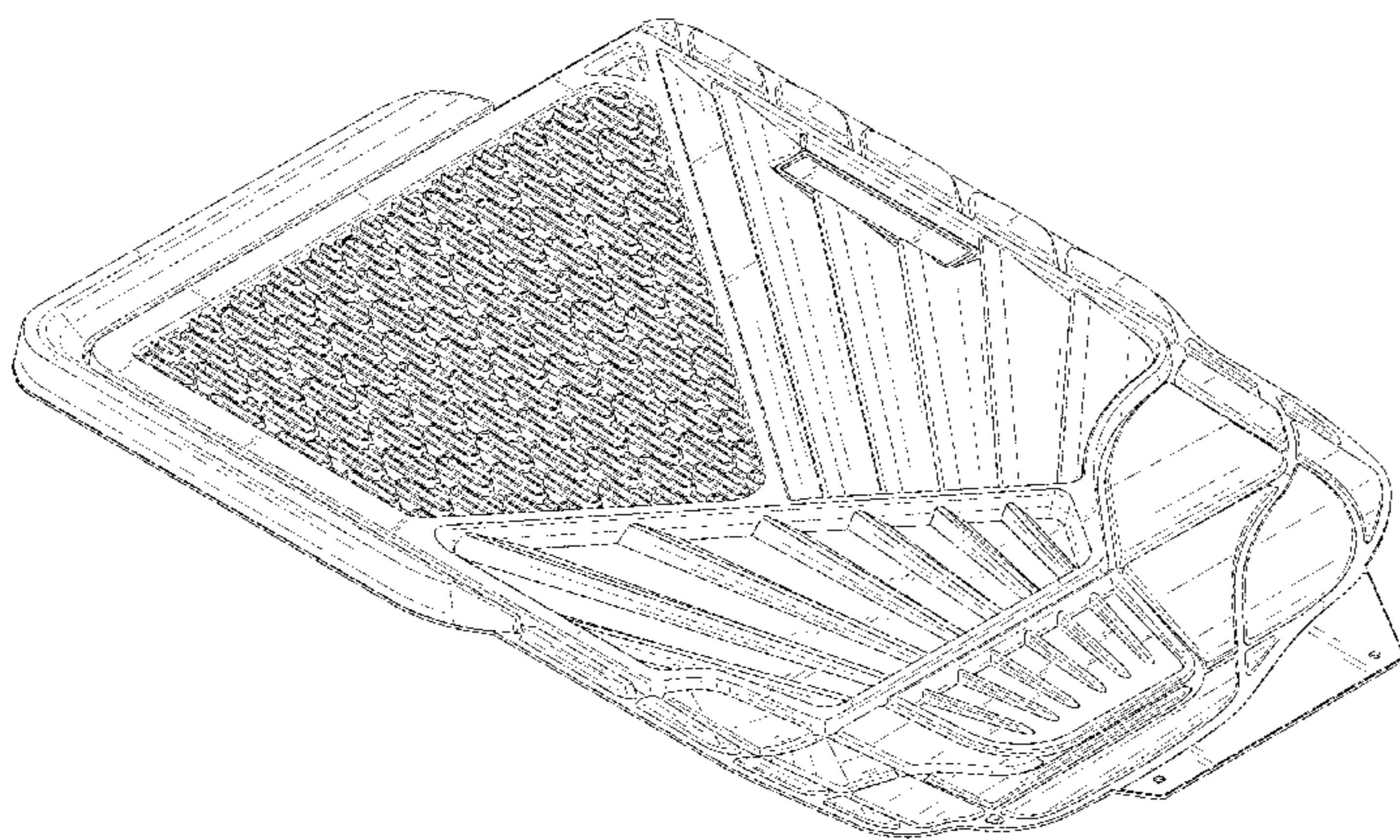

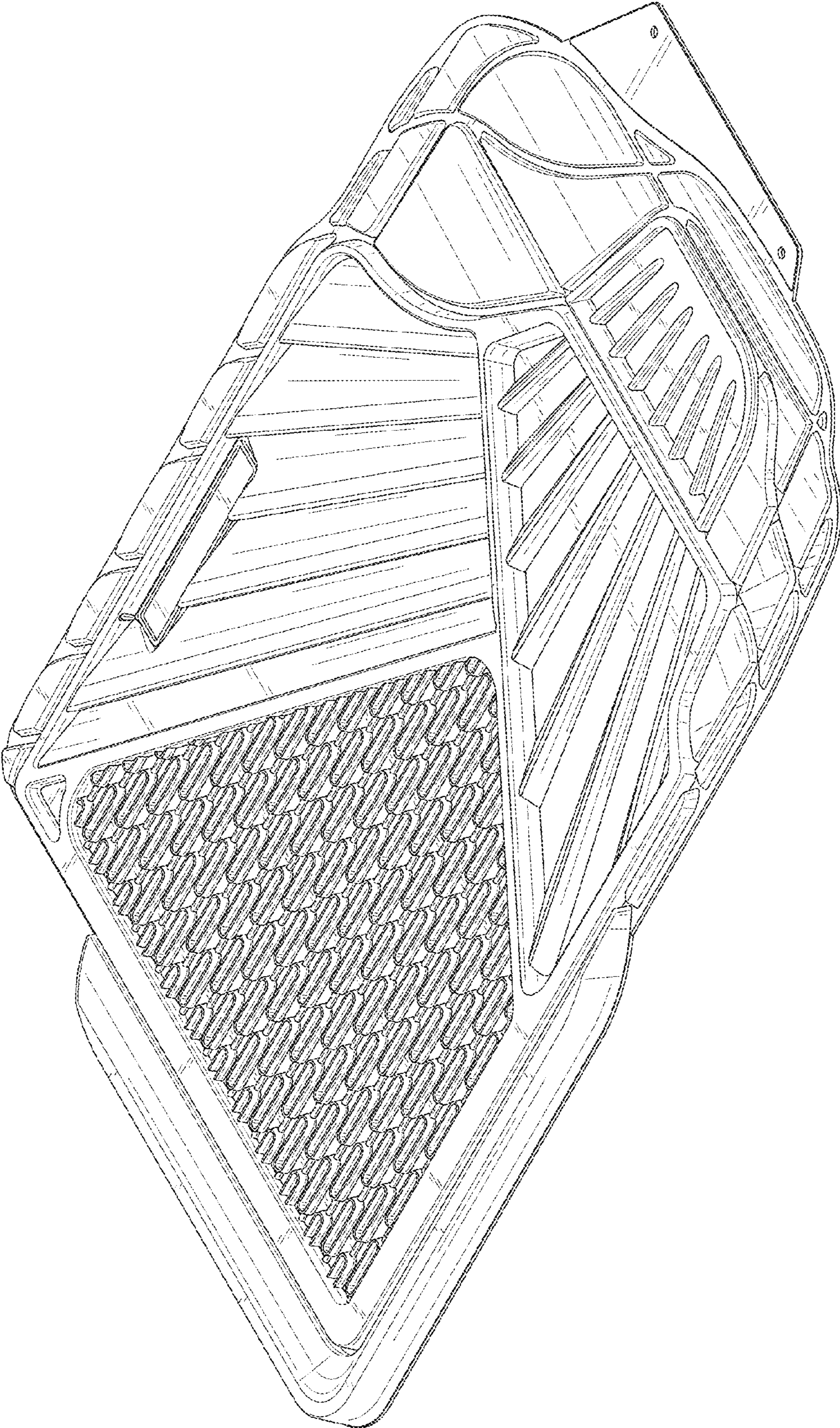

FIG. 1

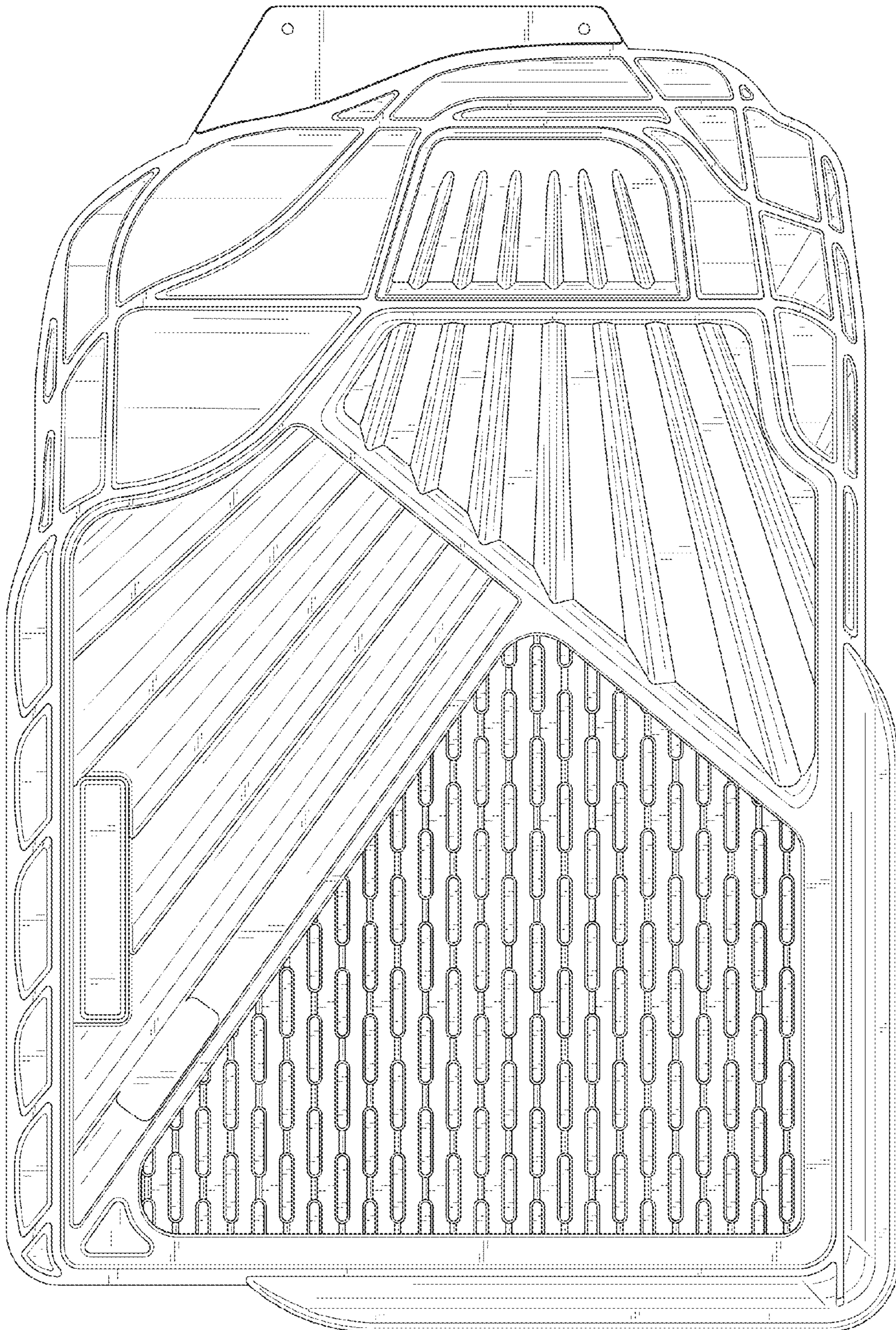

FIG. 2

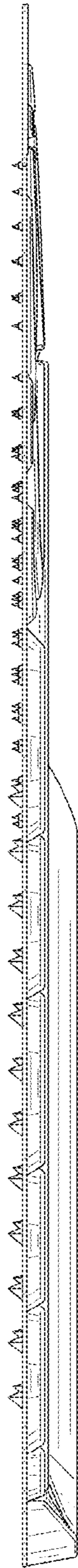

FIG. 3

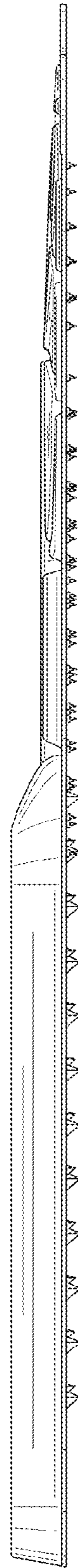

FIG. 4

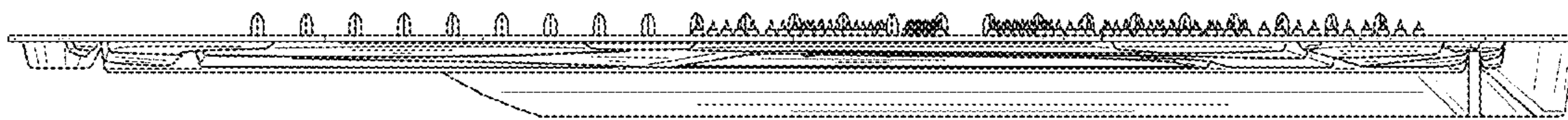

FIG. 5

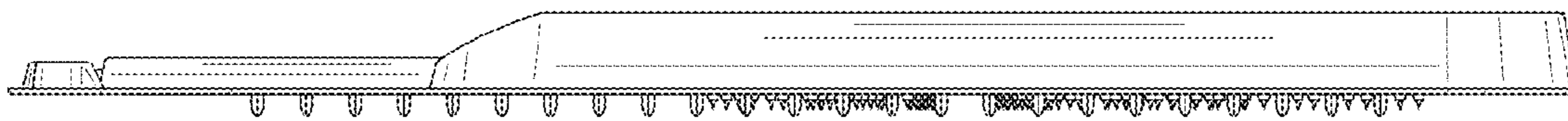

FIG. 6

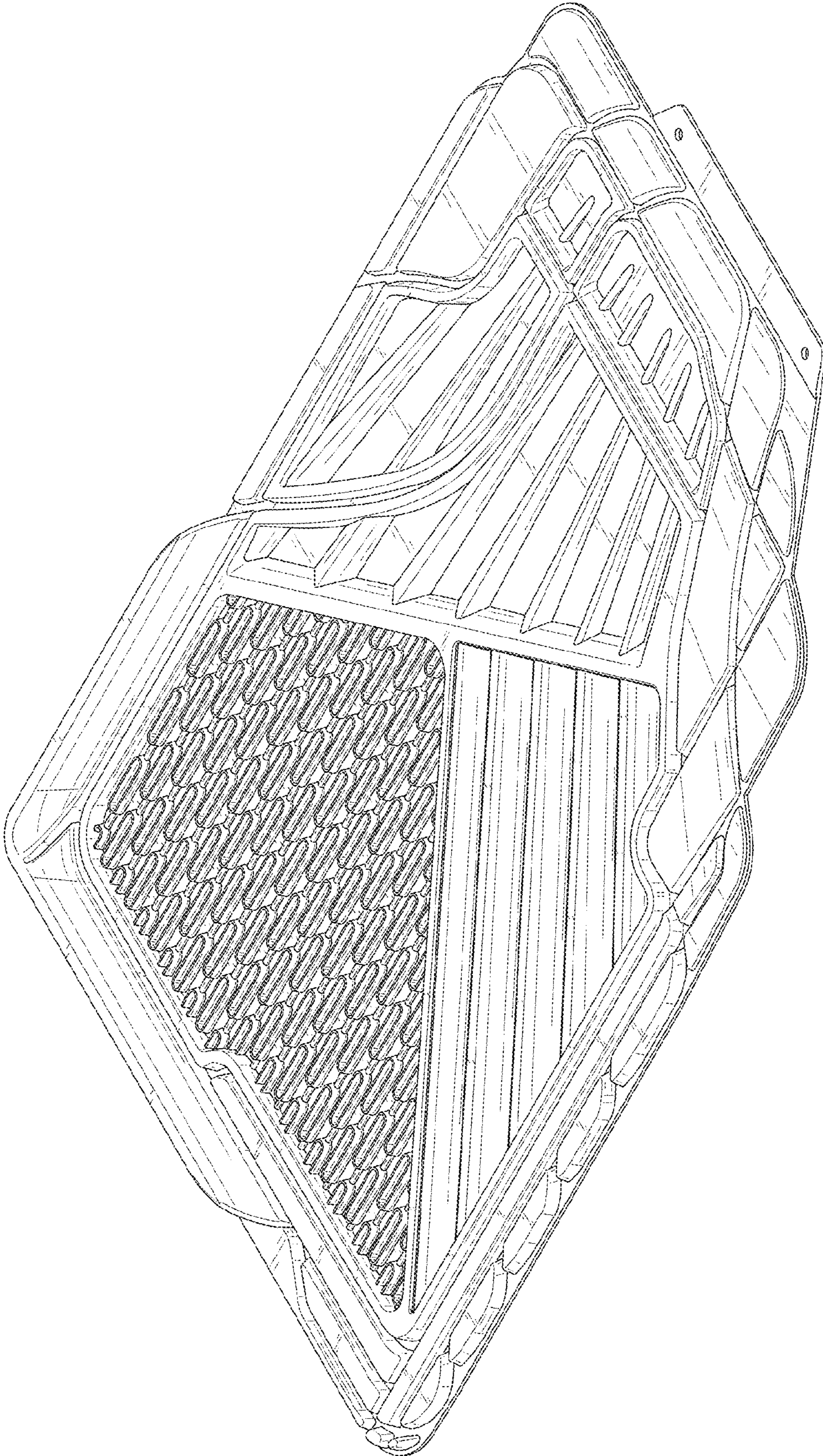

FIG. 7

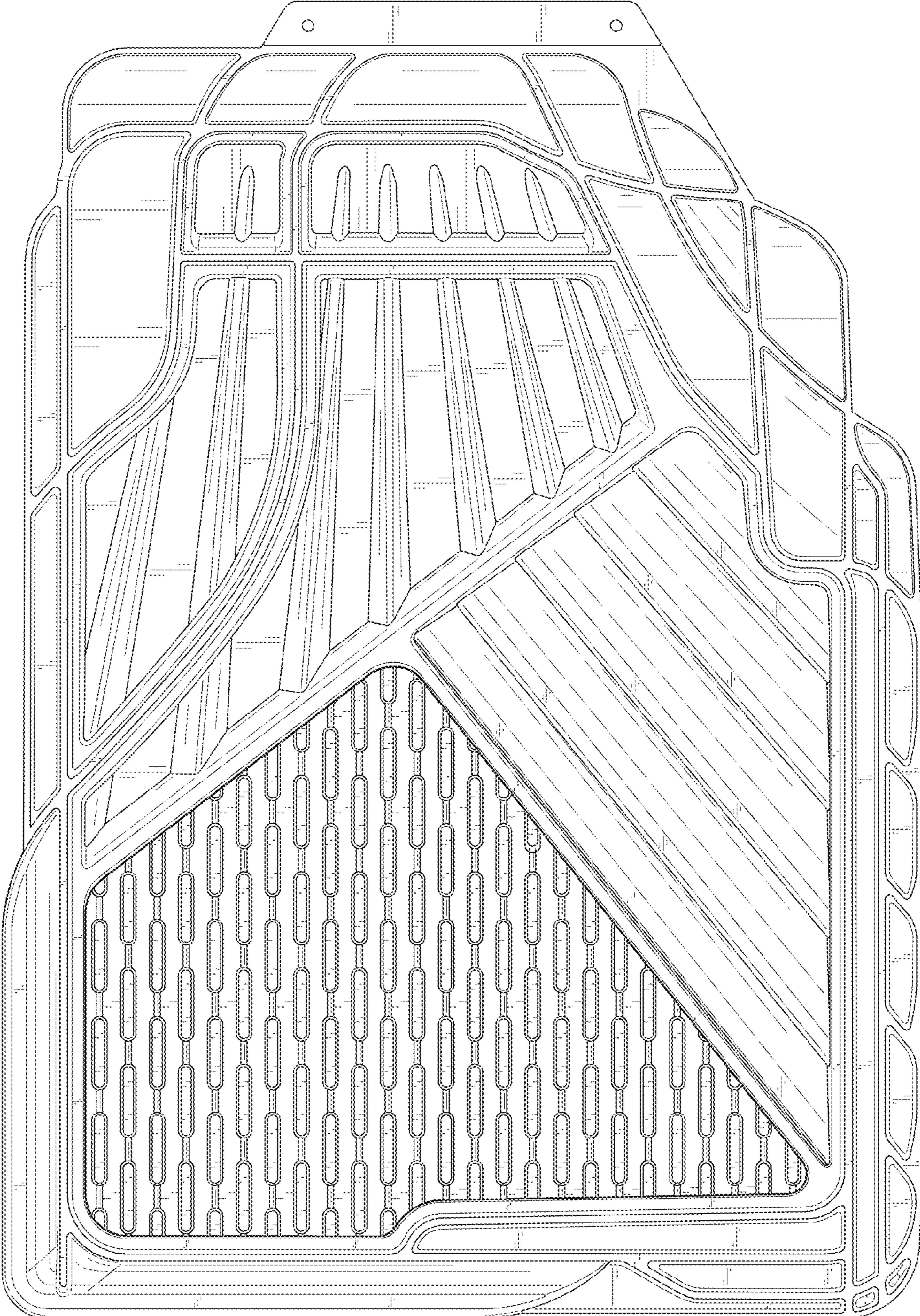

FIG. 8

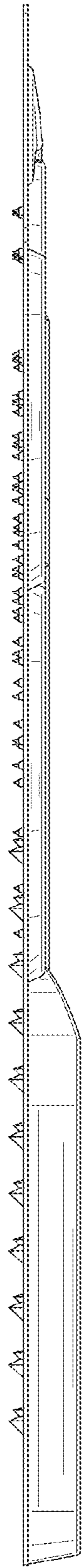

FIG. 9

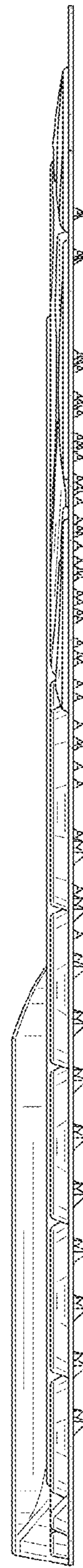

FIG. 10

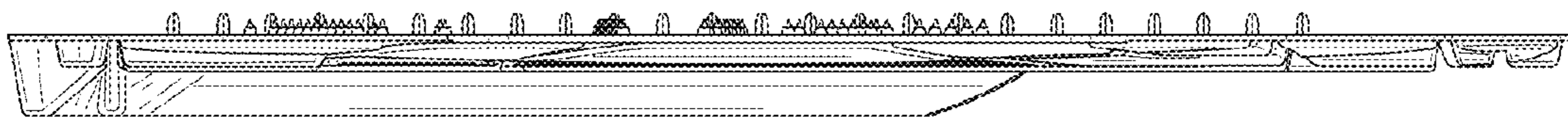

FIG.11

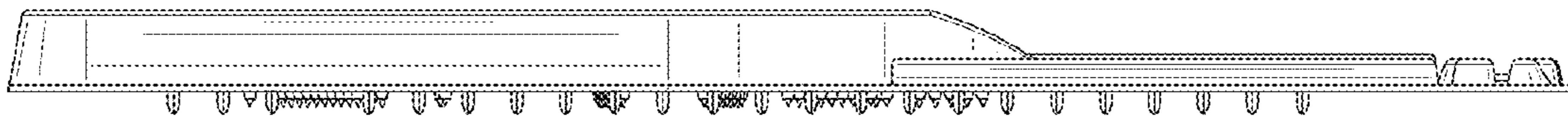

FIG.12