



US00D697779S

(12) **United States Design Patent**  
**Iwasaki**

(10) **Patent No.:** **US D697,779 S**  
(45) **Date of Patent:** **\*\* Jan. 21, 2014**

(54) **SEWING-ASSISTING CLIP**  
(75) Inventor: **Chihiro Iwasaki**, Osaka (JP)  
(73) Assignee: **Clover Mfg. Co., Ltd.**, Osaka (JP)  
(\*\*) Term: **14 Years**  
(21) Appl. No.: **29/430,083**  
(22) Filed: **Aug. 21, 2012**

(30) **Foreign Application Priority Data**  
May 21, 2012 (JP) ..... 2012-11782  
(51) **LOC (10) Cl.** ..... **08-05**  
(52) **U.S. Cl.**  
USPC ..... **D8/72**  
(58) **Field of Classification Search**  
USPC ..... D8/71-74, 394-399, 59; 24/507, 455,  
24/489, 499; 248/62, 63, 72, 74.1, 689,  
248/124.2; 81/487; 269/3, 4, 6, 143, 165,  
269/240, 243, 246-249, 254 R, 147-149;  
29/256, 257, 276; D15/140; D24/143;  
408/103, 104-109  
See application file for complete search history.

(56) **References Cited**  
U.S. PATENT DOCUMENTS  
D222,454 S \* 10/1971 Beeber ..... D8/72  
5,318,292 A \* 6/1994 De Marco ..... 24/489  
D447,048 S \* 8/2001 Beloff ..... D8/395

D450,571 S \* 11/2001 Chen ..... D8/395  
D552,978 S \* 10/2007 Liao ..... D8/395  
D571,179 S \* 6/2008 Ahlgren ..... D8/72  
D572,128 S \* 7/2008 Poulsen et al. .... D8/395  
D598,278 S \* 8/2009 Herman ..... D8/395  
D599,651 S \* 9/2009 Riggsbee ..... D8/395  
D665,246 S \* 8/2012 Laguelle ..... D8/395  
D670,998 S \* 11/2012 Lavoie et al. .... D8/395  
8,348,251 B2 \* 1/2013 Gallo ..... 269/3  
D682,080 S \* 5/2013 Borovicka et al. .... D8/395

\* cited by examiner

*Primary Examiner* — David Muller  
(74) *Attorney, Agent, or Firm* — Hamre, Shumann, Mueller & Larson, P.C.

(57) **CLAIM**  
I claim the ornamental design for a sewing-assisting clip, as shown and described.

**DESCRIPTION**  
FIG. 1 is a perspective view of a sewing-assisting clip according to my design;  
FIG. 2 is a front view thereof;  
FIG. 3 is a rear view thereof;  
FIG. 4 is a left side view thereof;  
FIG. 5 is a right side view thereof;  
FIG. 6 is a top plan view thereof; and,  
FIG. 7 is a bottom view thereof.  
The broken lines in the drawings are for illustration purposes only and form no part of the claimed design.

**1 Claim, 4 Drawing Sheets**

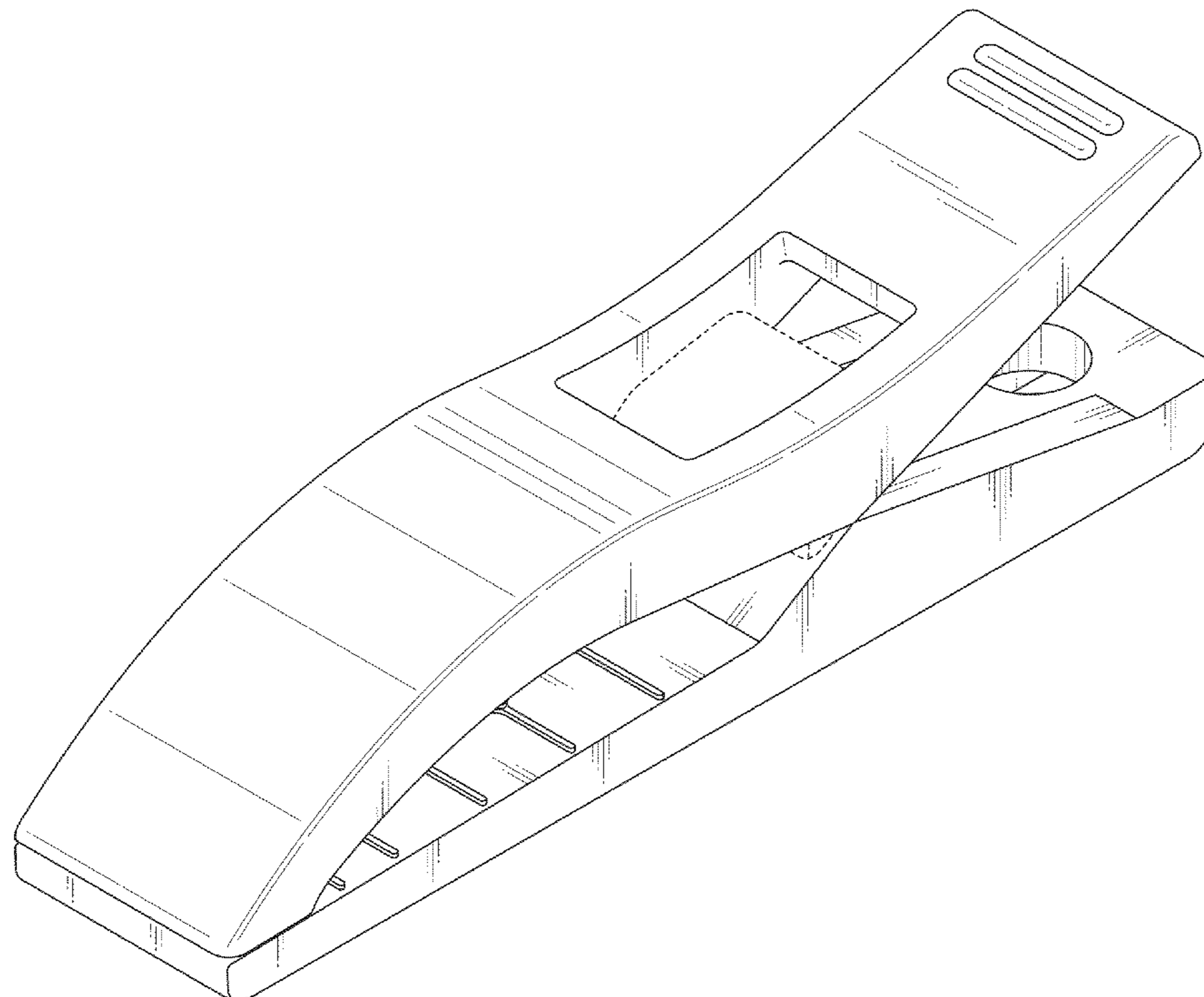

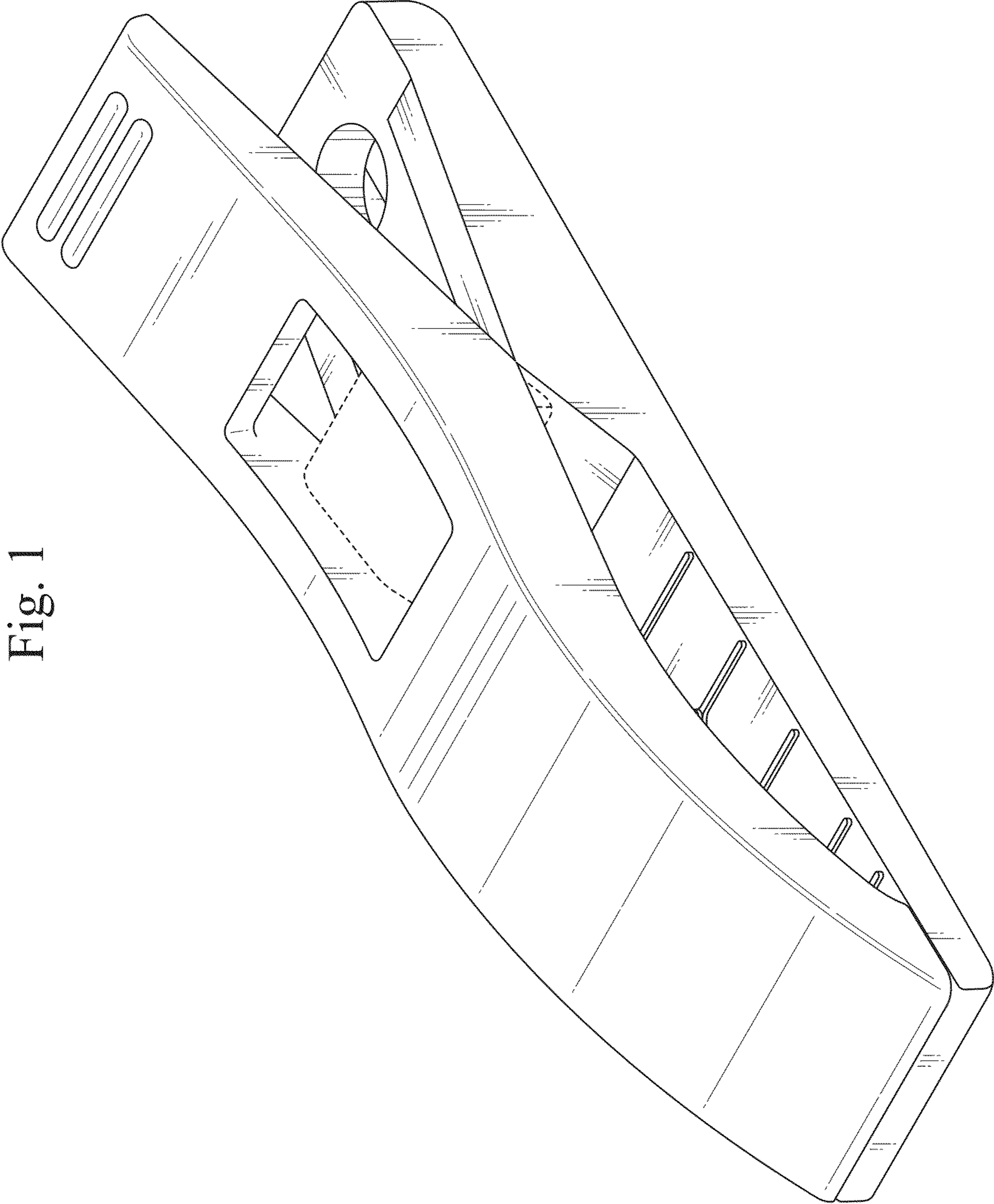

Fig. 1

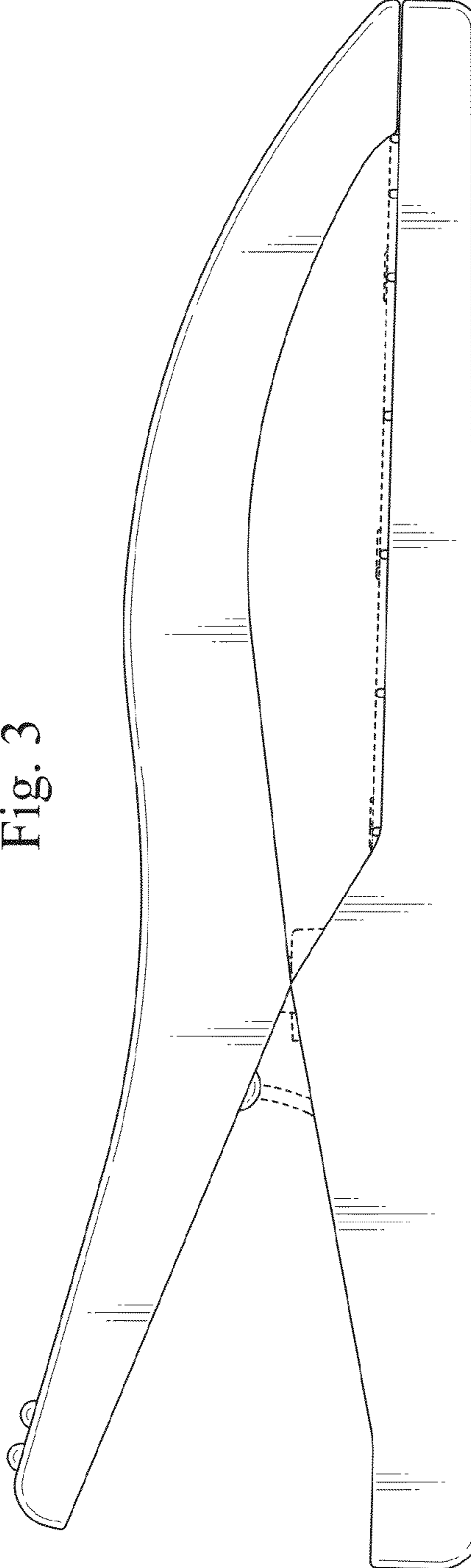
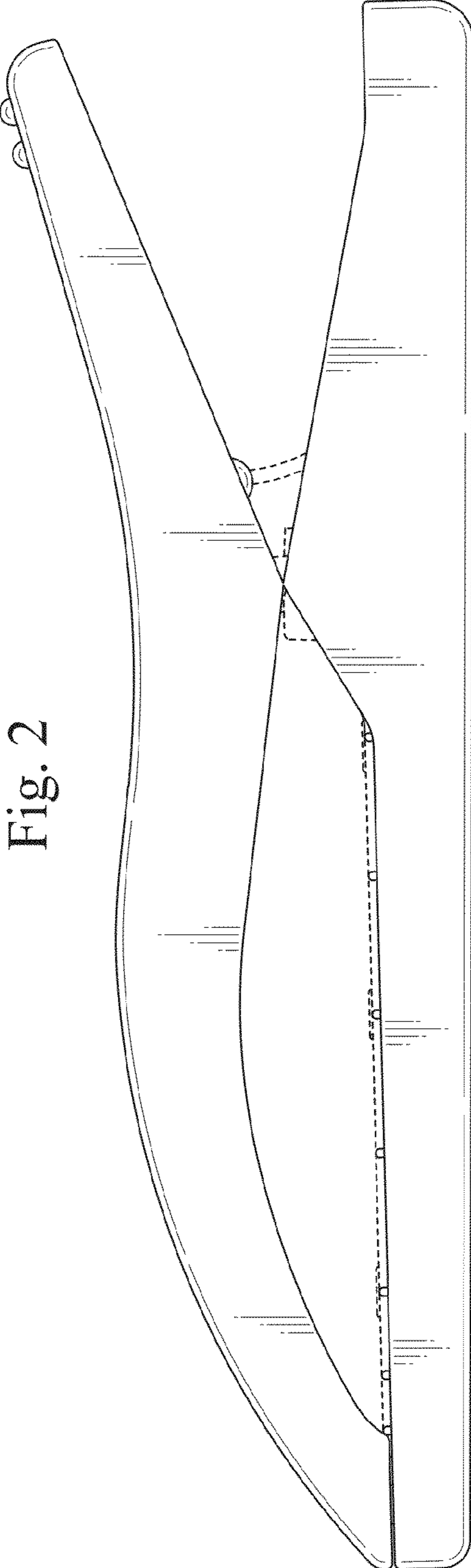

Fig. 5

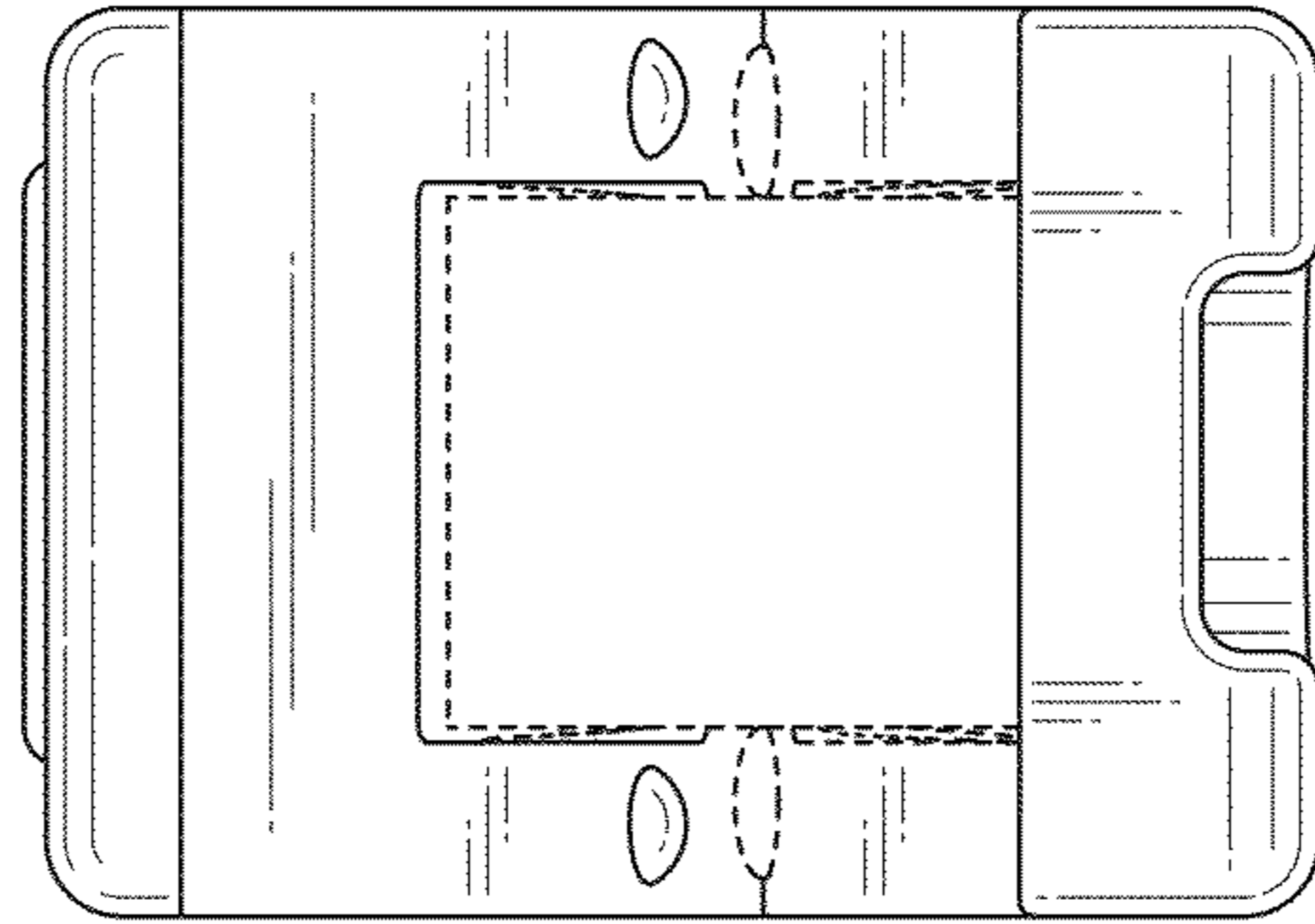

Fig. 4

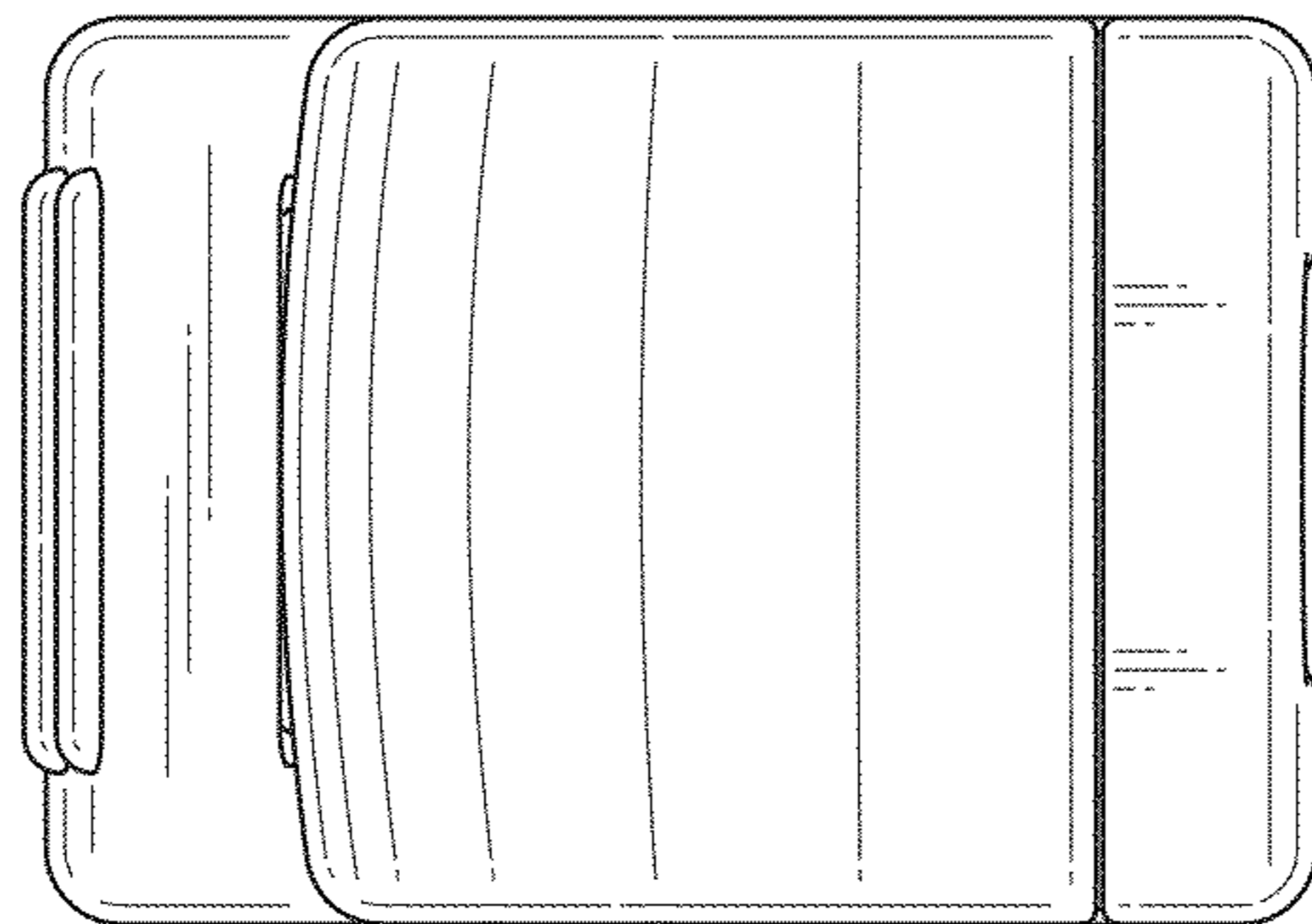

Fig. 6

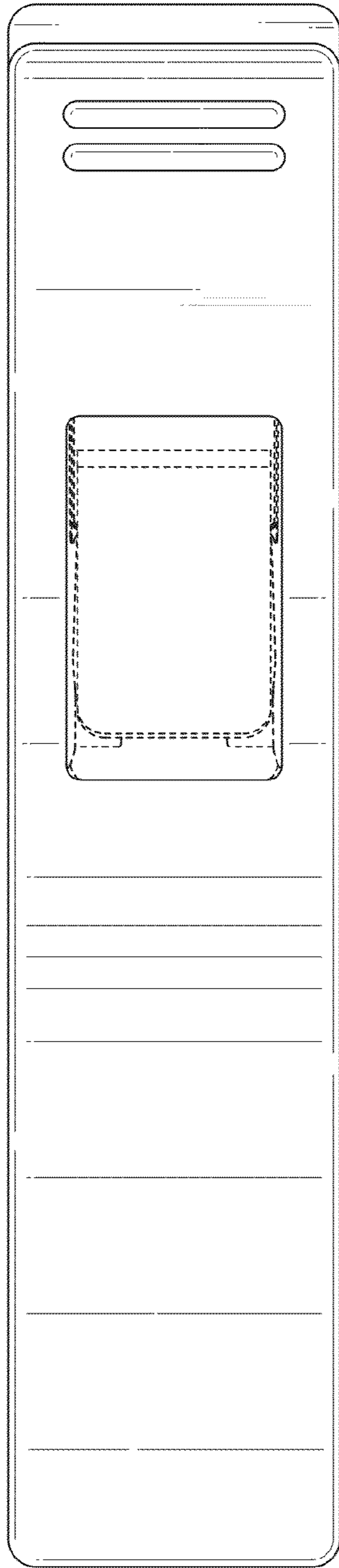

Fig. 7

