



US00D697746S

(12) **United States Design Patent**
Kubryk

(10) **Patent No.:** **US D697,746 S**

(45) **Date of Patent:** **** Jan. 21, 2014**

(54) **TASK CHAIR**

(71) Applicant: **Isaac Kubryk**, Lockeford, CA (US)

(72) Inventor: **Isaac Kubryk**, Lockeford, CA (US)

(**) Term: **14 Years**

(21) Appl. No.: **29/451,308**

(22) Filed: **Mar. 29, 2013**

(51) **LOC (10) Cl.** **06-01**

(52) **U.S. Cl.**
USPC **D6/716**

(58) **Field of Classification Search**
USPC D6/334-33, 344, 364, 365, 366, 367,
D6/374, 375, 376, 716, 716.1, 716.2,
D6/716.3, 716.4; 297/411.2, 411.27,
297/411.28, 452.12, 452.19, 452.26,
297/452.29, 452.32, 452.35, 452.48

See application file for complete search history.

(56) **References Cited**

U.S. PATENT DOCUMENTS

D235,233 S * 6/1975 Prizlow D6/366
D241,288 S * 9/1976 Tacke D6/366
D260,204 S * 8/1981 Sapper D6/366

D622,986 S * 9/2010 Kubryk D6/716
D622,987 S * 9/2010 Kubryk D6/716
D654,730 S * 2/2012 Kubryk D6/716
D654,731 S * 2/2012 Kubryk D6/716
D663,975 S * 7/2012 Kubryk D6/716
D663,976 S * 7/2012 Kubryk D6/716
D680,344 S * 4/2013 Lievore et al. D6/366

* cited by examiner

Primary Examiner — Mimoso De

(74) *Attorney, Agent, or Firm* — Audrey A. Millemann;
Weintraub Tobin, et al.

(57) **CLAIM**

The ornamental design for a task chair, as shown and described.

DESCRIPTION

FIG. 1 is a perspective view of a task chair, looking toward the right front corner, showing my new design;
FIG. 2 is a front view thereof;
FIG. 3 is a back view thereof;
FIG. 4 is a right side view thereof;
FIG. 5 is a top view thereof; and,
FIG. 6 is a bottom view thereof.
The broken lines shown in the drawing are for illustrative purposes only and form no part of the claimed design.

1 Claim, 5 Drawing Sheets

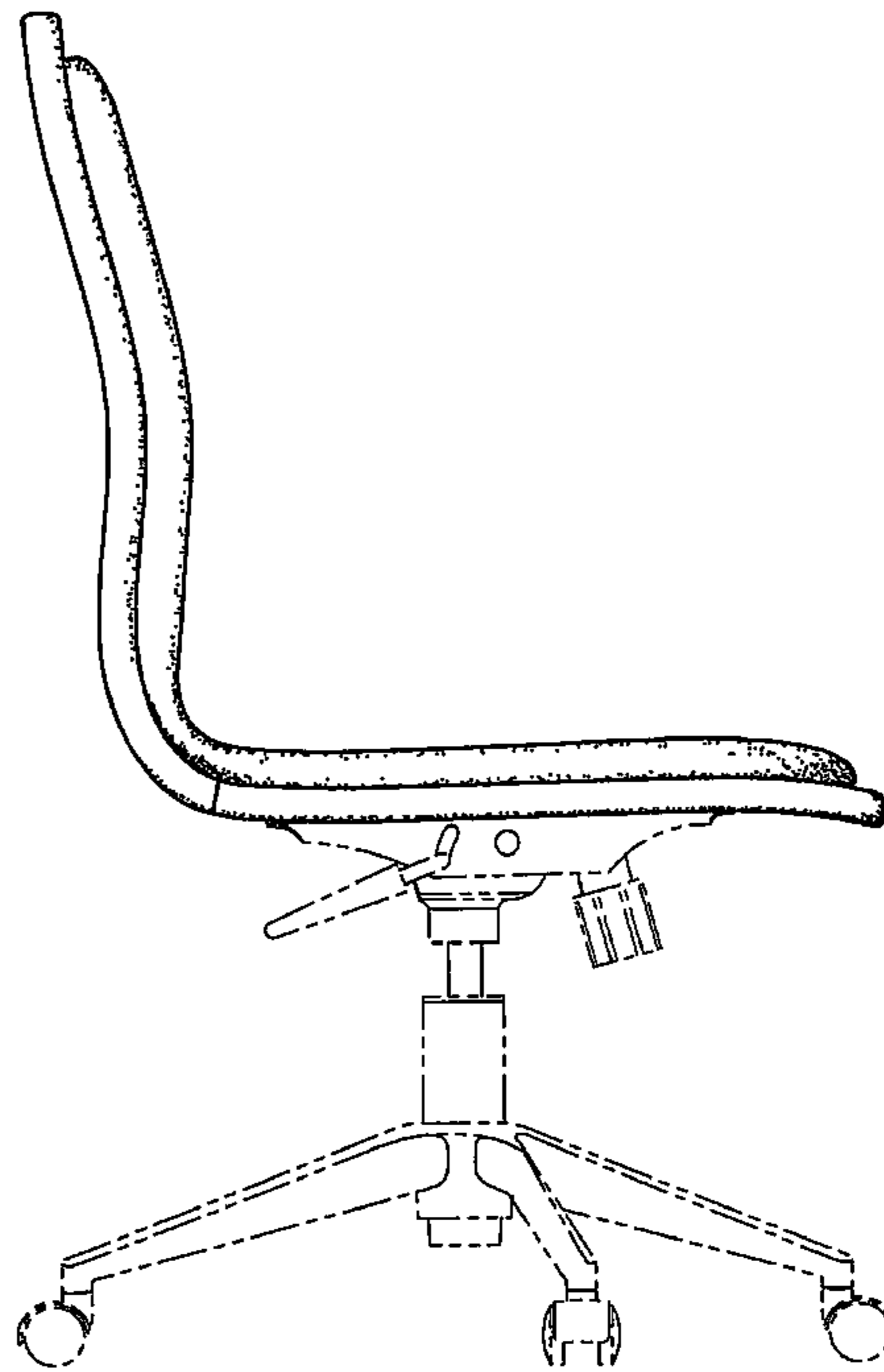
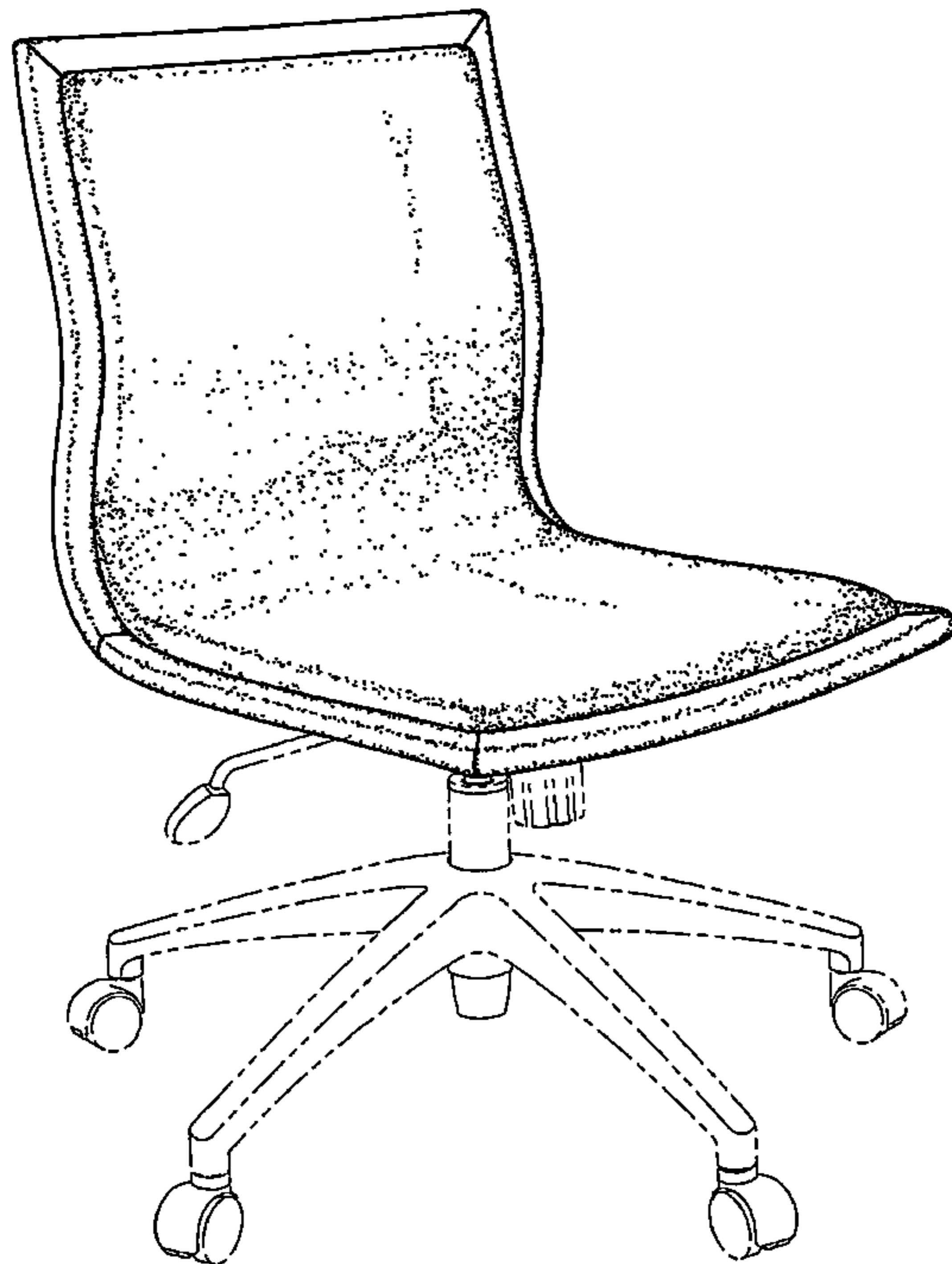

FIG. 1

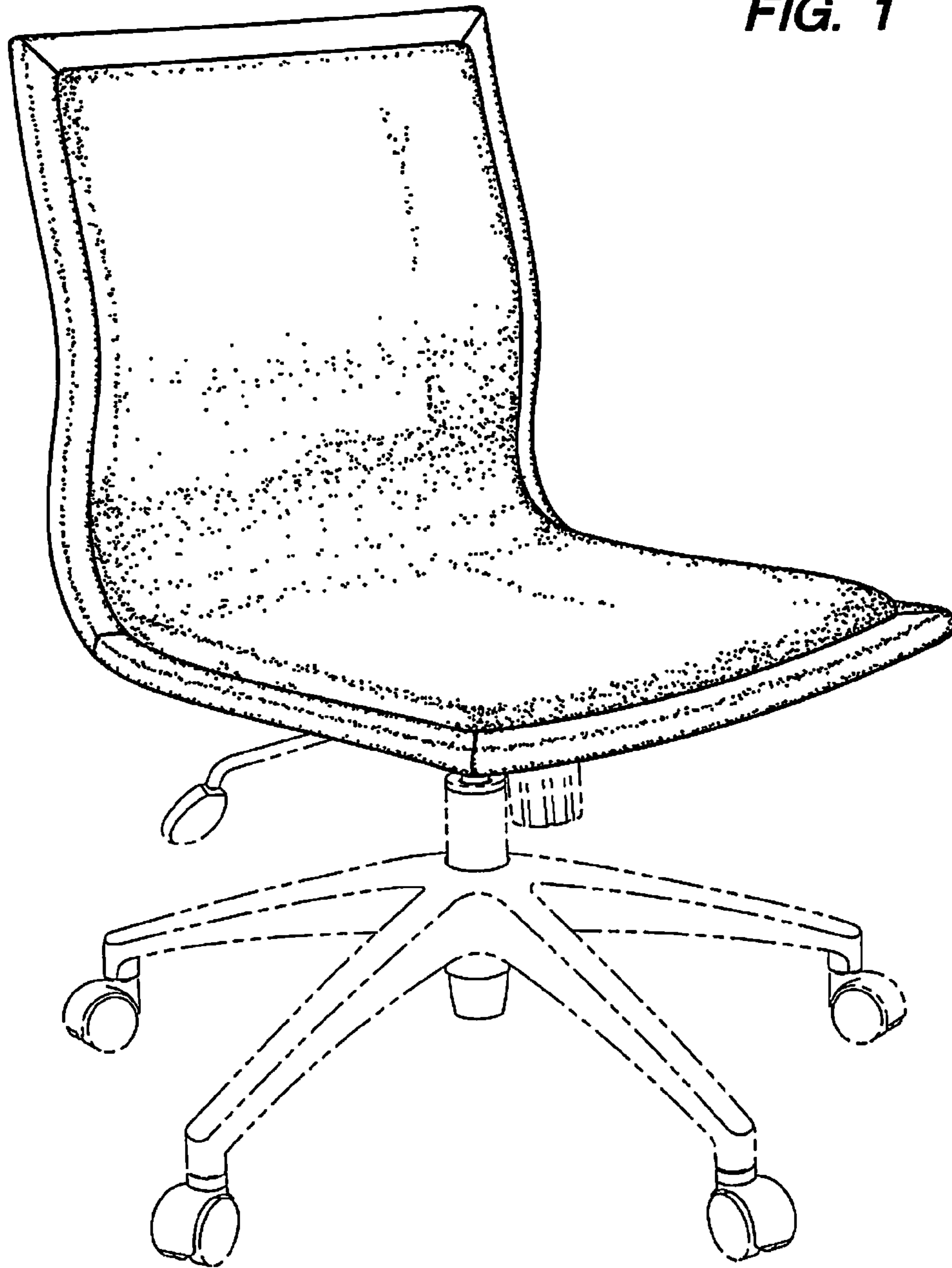

FIG. 2

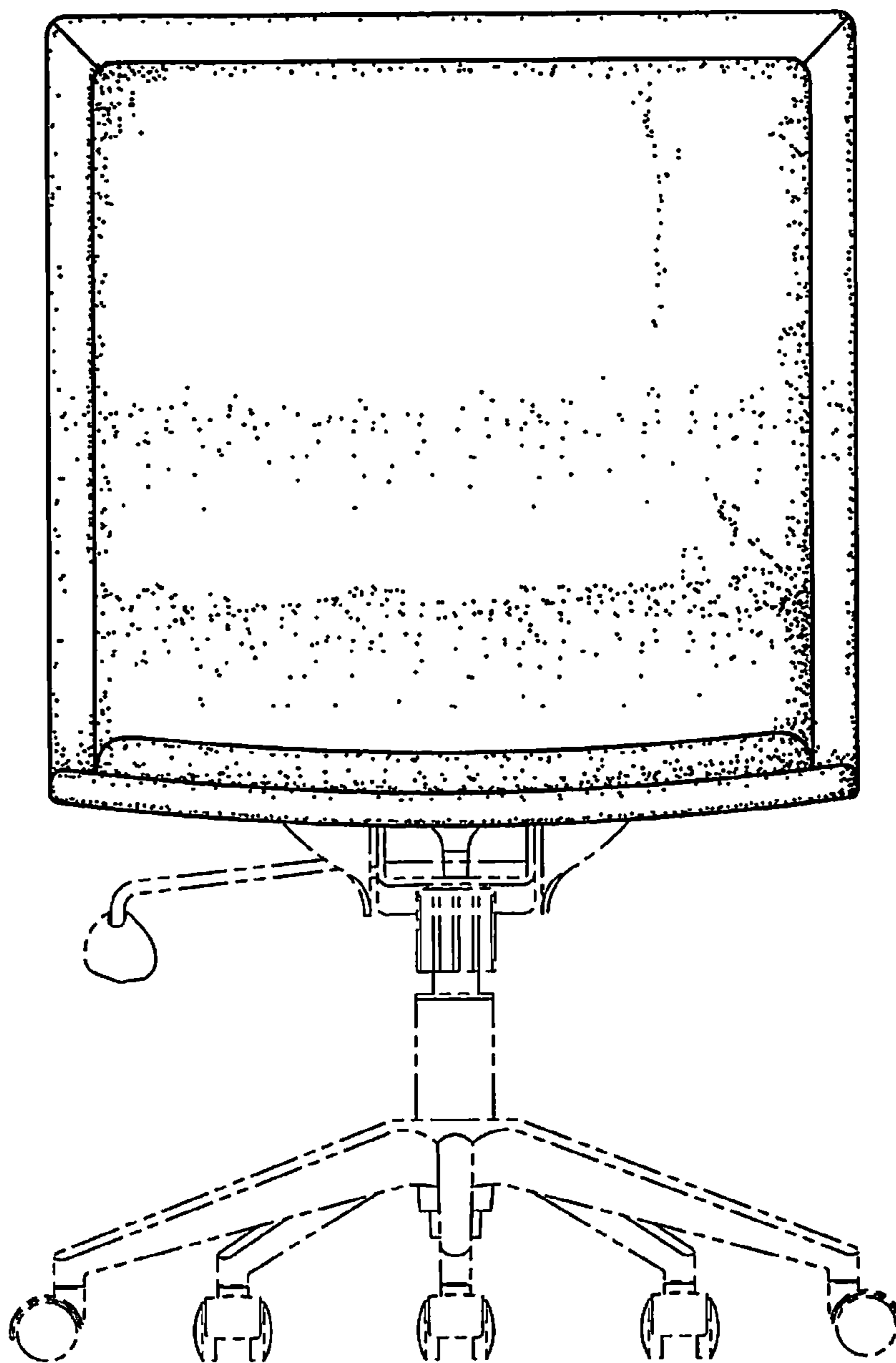

FIG. 3

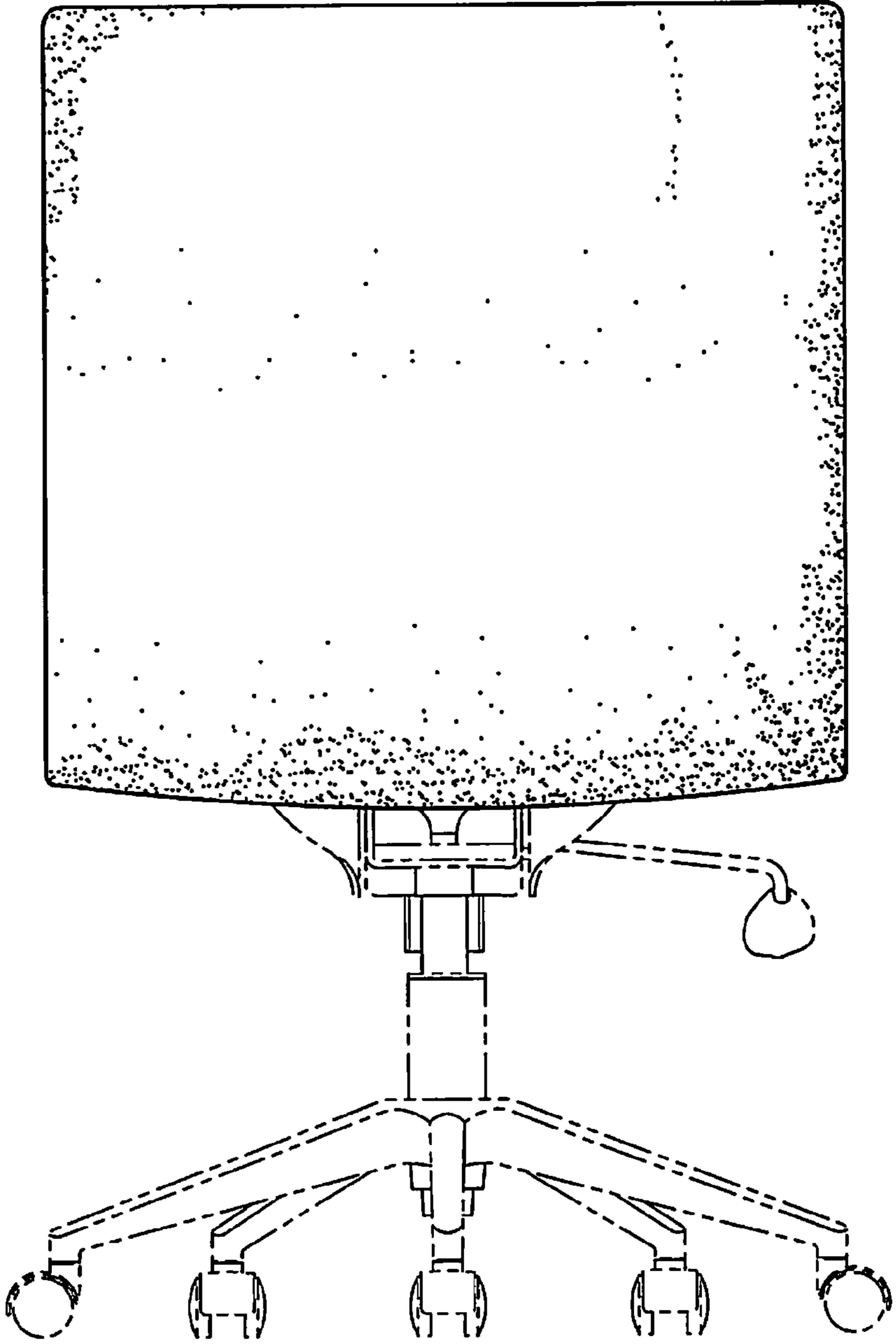
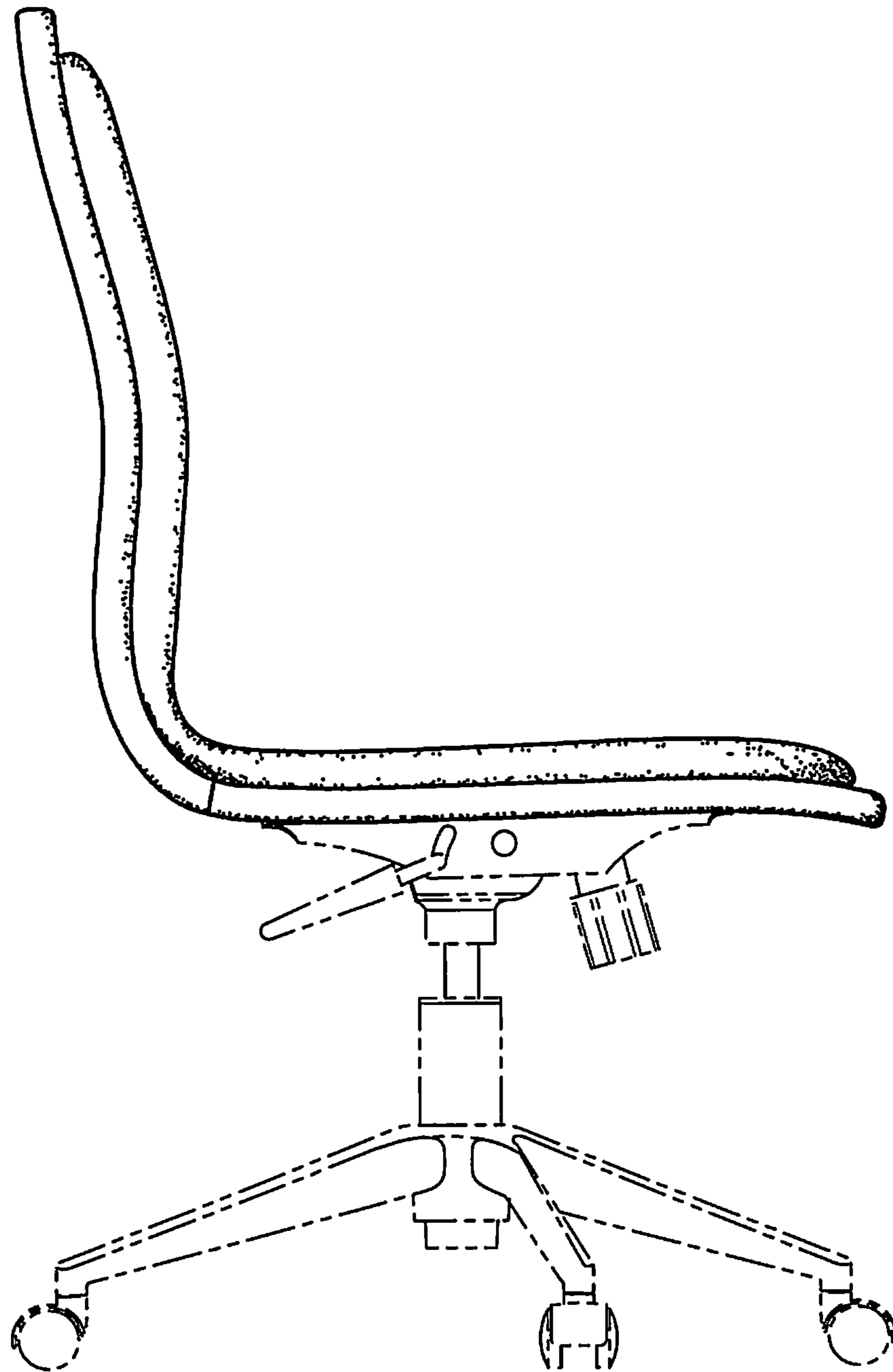

FIG. 4



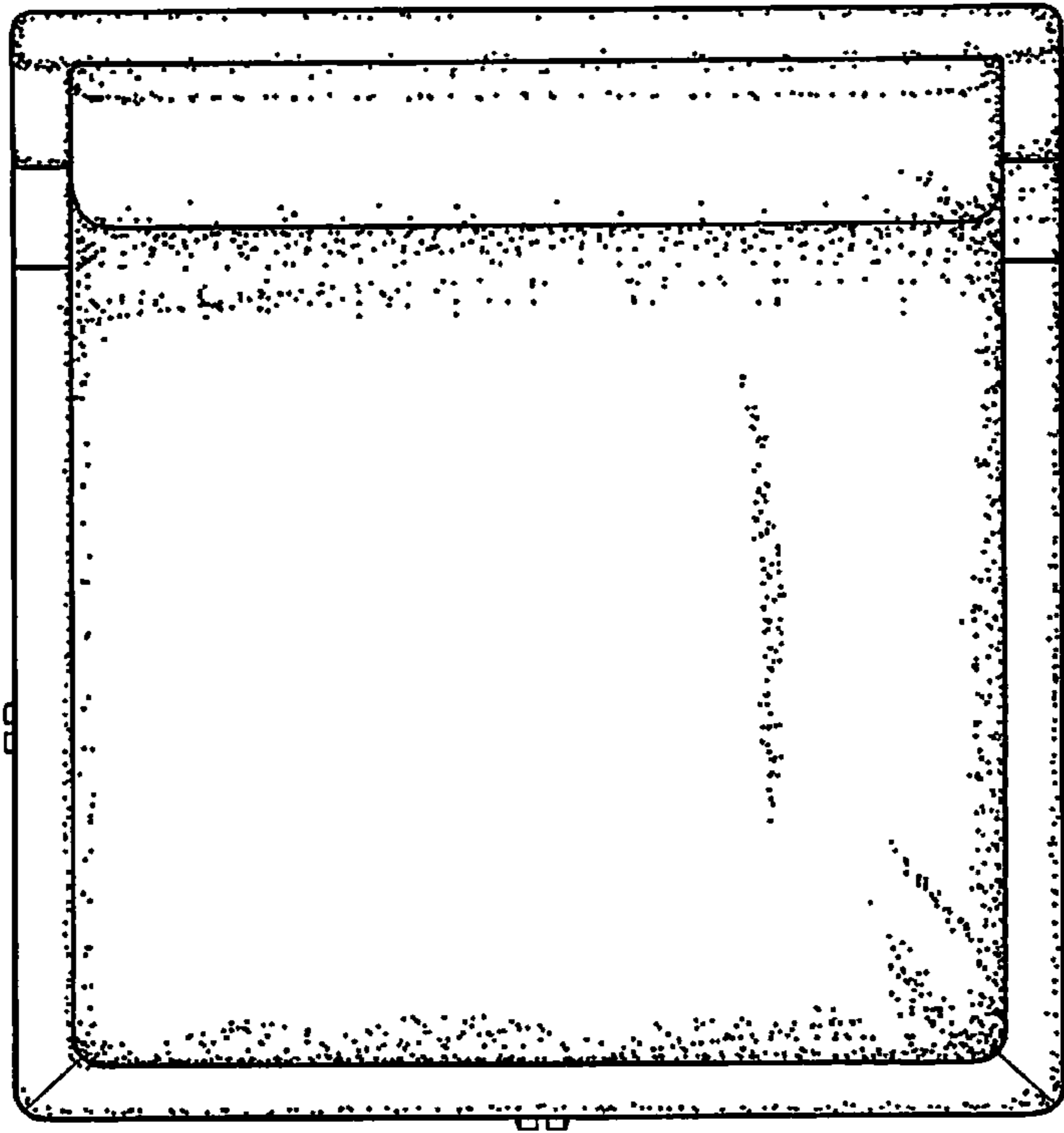

FIG. 5

FIG. 6

