

US00D697631S

(12) **United States Design Patent**
Marshall

(10) **Patent No.:** **US D697,631 S**
(45) **Date of Patent:** **** Jan. 14, 2014**

(54) **VIBRATOR**

(71) Applicant: **Ian Peter Marshall**, Kettering (GB)

(72) Inventor: **Ian Peter Marshall**, Kettering (GB)

(**) Term: **14 Years**

(21) Appl. No.: **29/461,040**

(22) Filed: **Jul. 18, 2013**

(51) **LOC (10) Cl.** **28-03**

(52) **U.S. Cl.**
USPC **D24/215**

(58) **Field of Classification Search**
USPC D24/200, 211, 212, 213, 214, 215;
601/114, 120, 121, 124, 125, 130, 131,
601/134, 135, 136, 137
See application file for complete search history.

(56) **References Cited**

U.S. PATENT DOCUMENTS

5,690,603 A * 11/1997 Kain 600/38
D592,758 S * 5/2009 Kain D24/215
D605,779 S * 12/2009 Murison D24/215

D630,762 S * 1/2011 Elliott D24/215
D630,764 S * 1/2011 Elliott D24/215
7,931,605 B2 * 4/2011 Murison 601/70
D652,942 S * 1/2012 Murison D24/215
D665,094 S * 8/2012 Sedic D24/215
D681,221 S * 4/2013 Chen D24/215
D688,381 S * 8/2013 Marshall D24/215
D688,383 S * 8/2013 Manabe D24/215
2008/0009775 A1 * 1/2008 Murison 601/46
2011/0124959 A1 * 5/2011 Murison 600/38

* cited by examiner

Primary Examiner — Sandra Snapp

(57) **CLAIM**
The ornamental design for a vibrator, as shown and described.

DESCRIPTION

FIG. 1 is an isometric view of a vibrator showing my new design;
FIG. 2 is a rear view thereof;
FIG. 3 is a front view thereof;
FIG. 4 is a left view thereof;
FIG. 5 is a right view thereof;
FIG. 6 is a top plan view thereof; and,
FIG. 7 is a bottom plan view thereof.

1 Claim, 7 Drawing Sheets

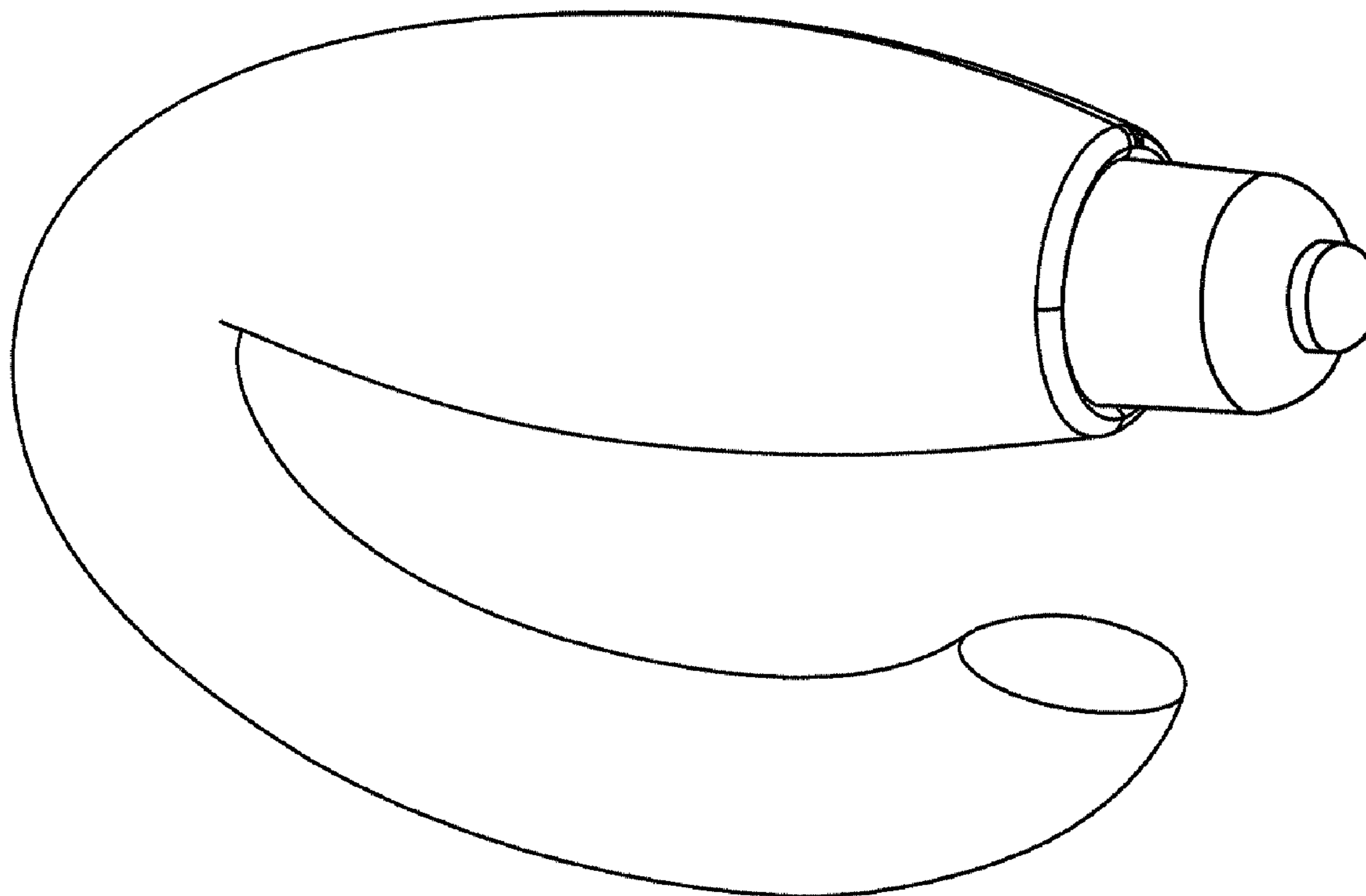

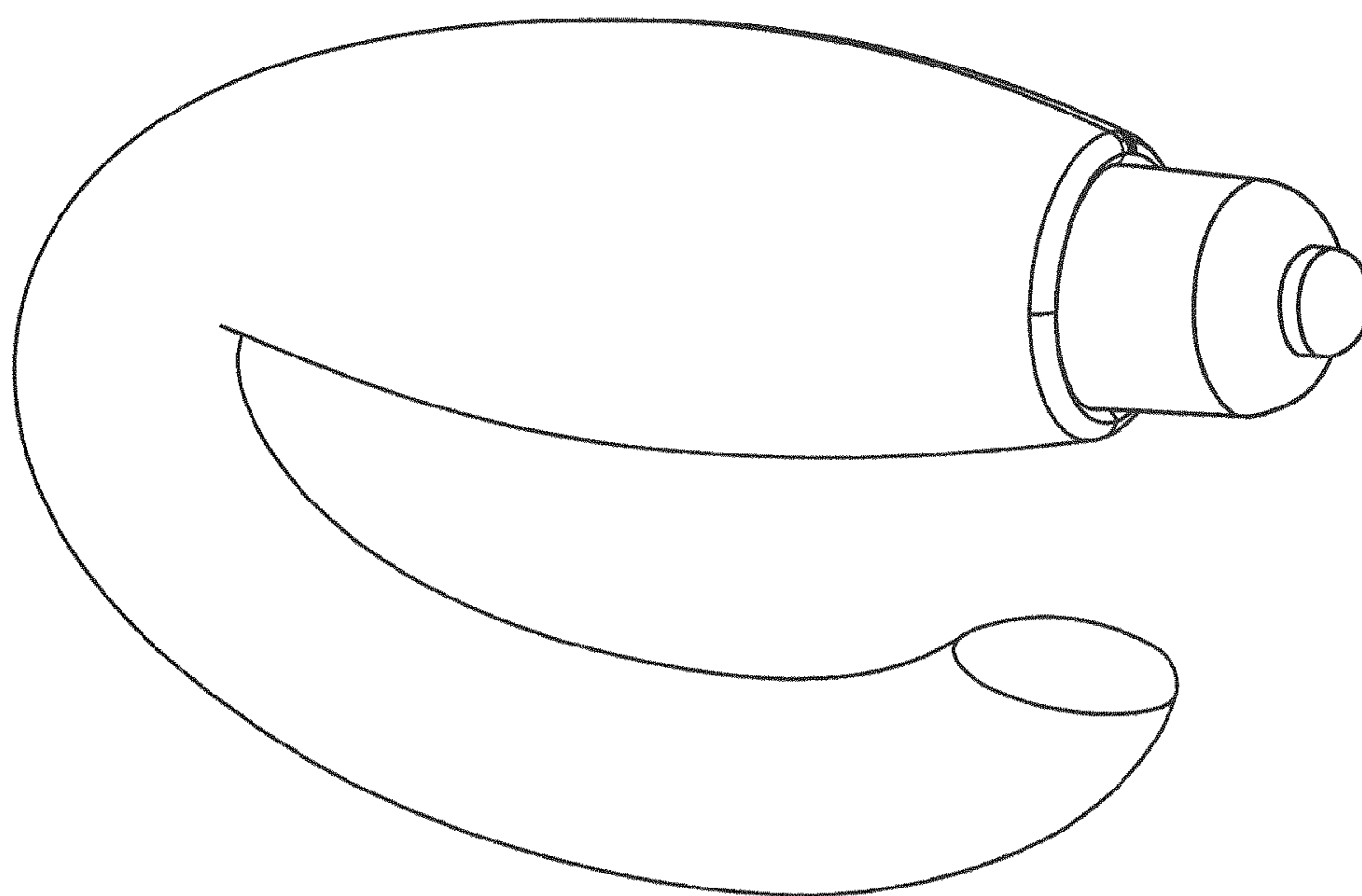

FIG. 1

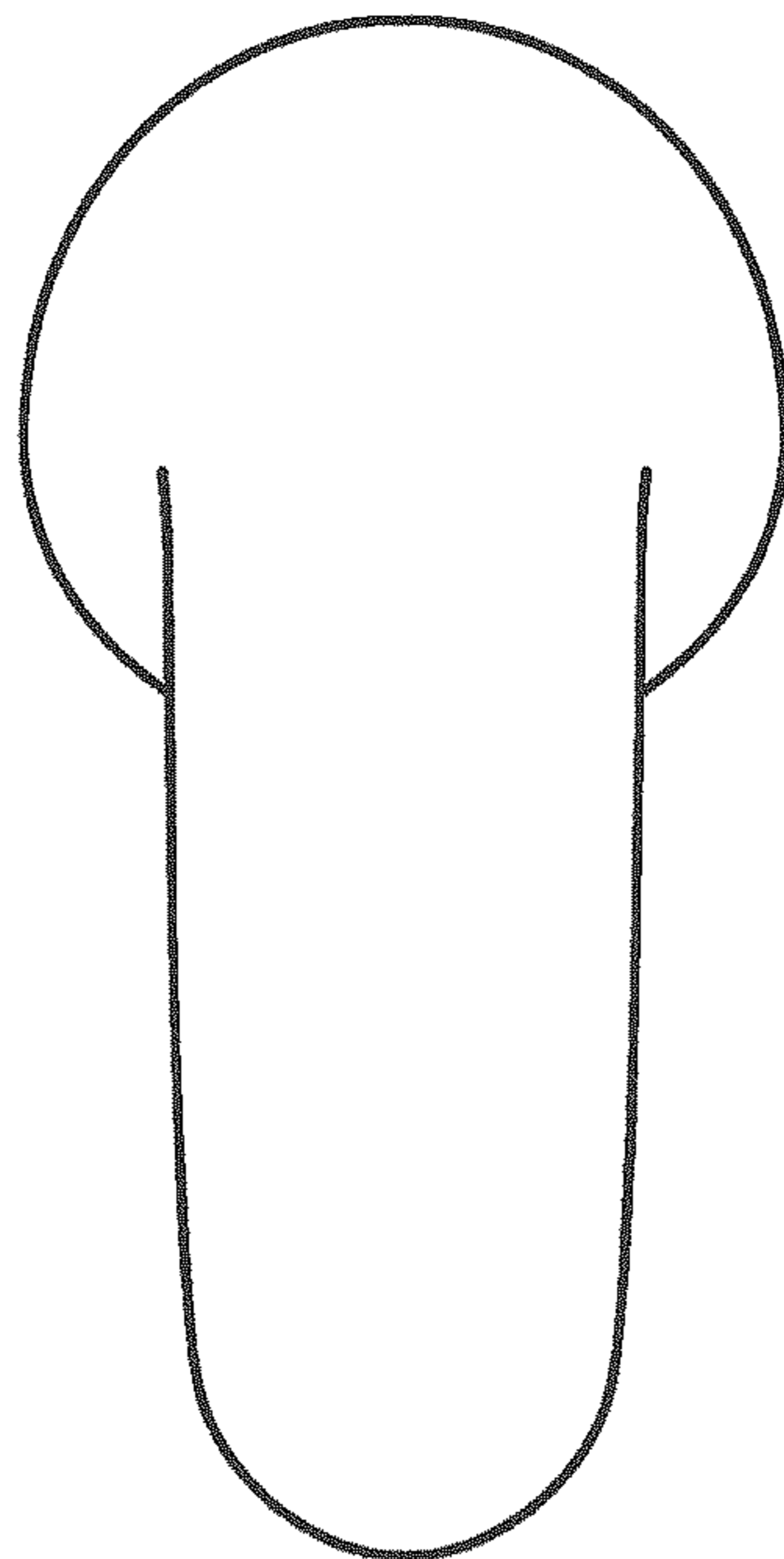

FIG. 2

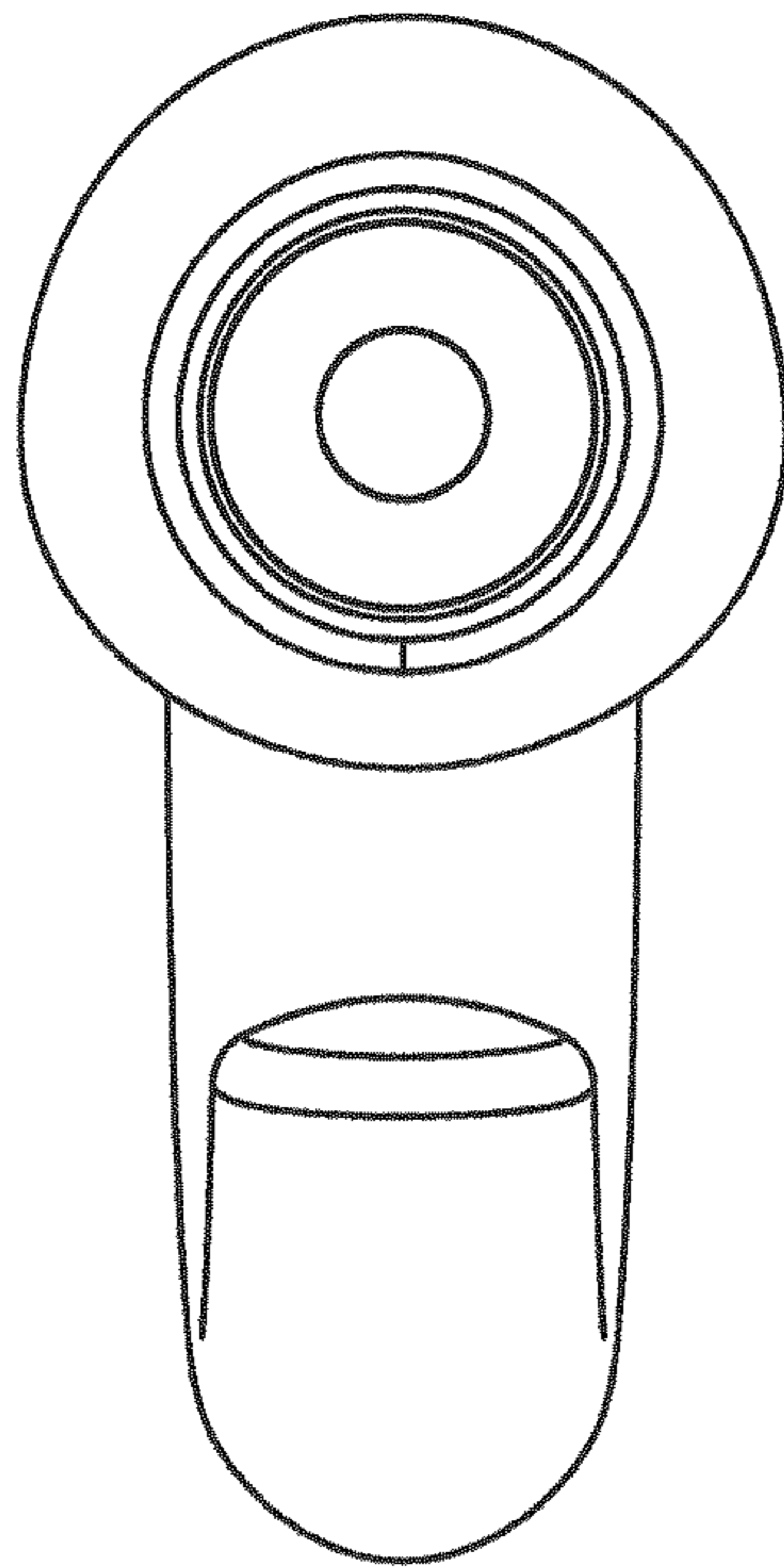

FIG. 3

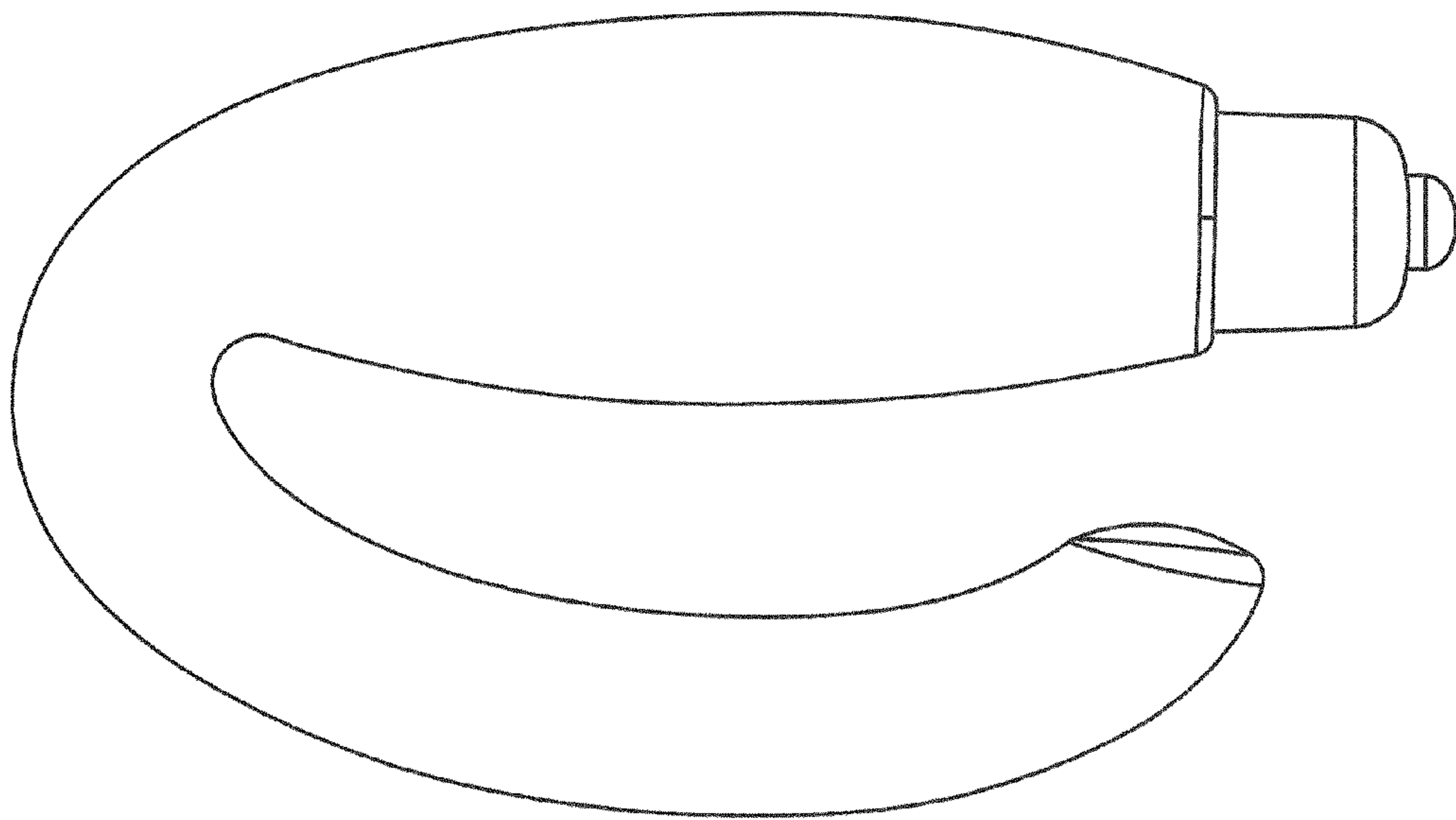

FIG. 4

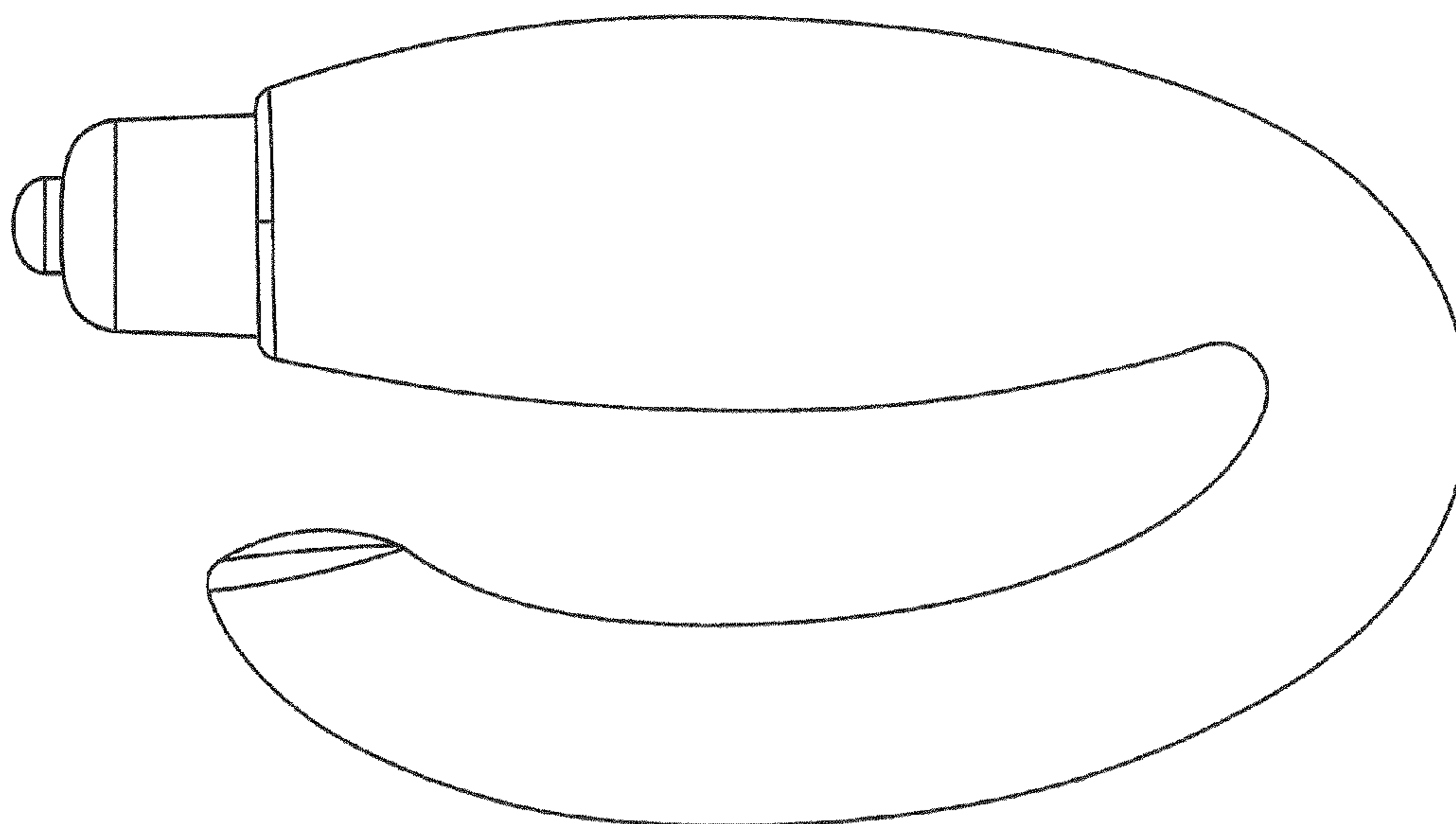

FIG. 5

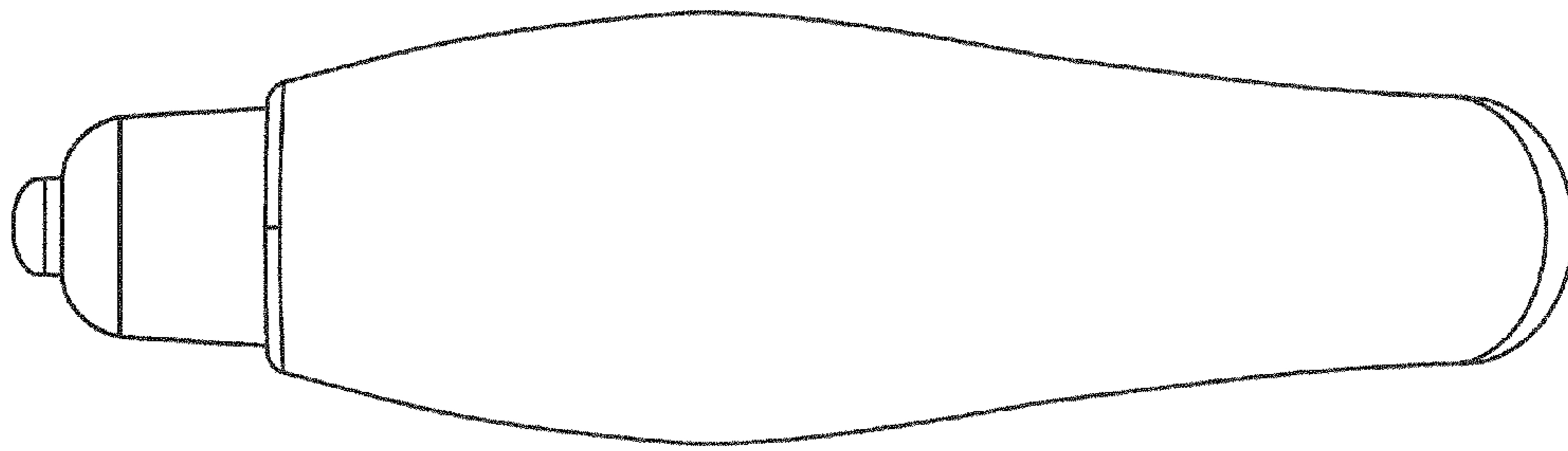

FIG.6

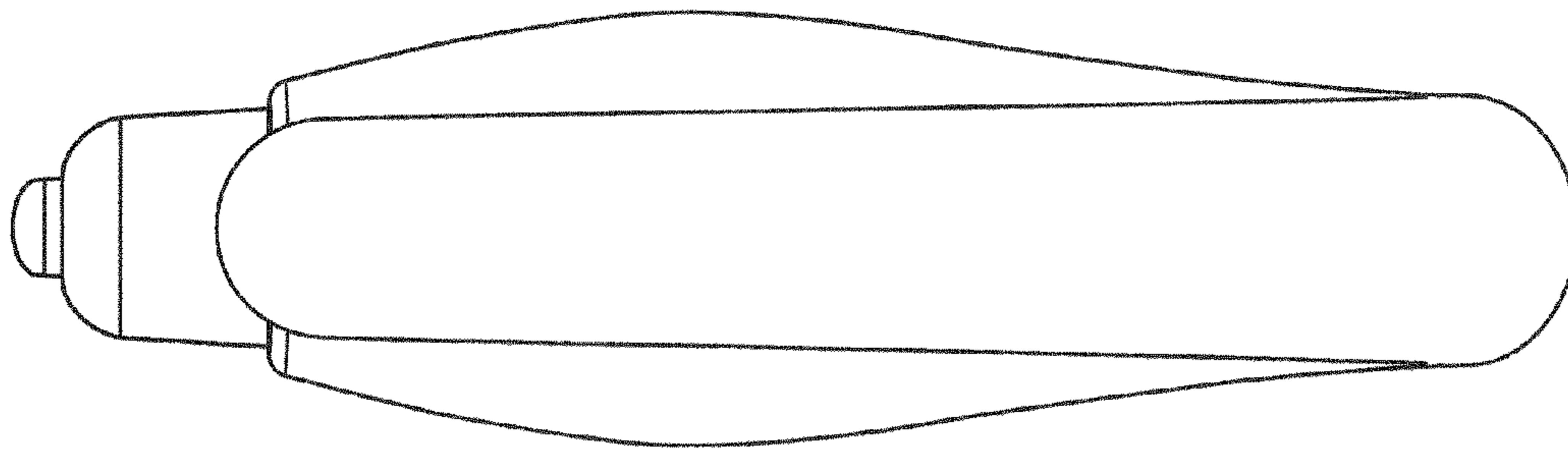

FIG. 7