



US00D697422S

(12) **United States Design Patent**
Changpan

(10) **Patent No.:** **US D697,422 S**

(45) **Date of Patent:** **** Jan. 14, 2014**

(54) **FOOD CONTAINER**

(75) **Inventor:** **Trad Changpan**, Samutsakorn (TH)

(73) **Assignee:** **The Union Frozen Products Co., Ltd.**,
Samutsakorn (TH)

(**) **Term:** **14 Years**

(21) **Appl. No.:** **29/427,329**

(22) **Filed:** **Jul. 17, 2012**

(30) **Foreign Application Priority Data**

Feb. 7, 2012 (TH) 1202000275

(51) **LOC (10) Cl.** **09-01**

(52) **U.S. Cl.**
USPC **D9/629**

(58) **Field of Classification Search**
USPC D9/600, 629, 761, 414, 424-426;
D3/270-271.1; D7/628-629;
229/116.1-116.2; 206/457-458
See application file for complete search history.

(56) **References Cited**

U.S. PATENT DOCUMENTS

3,610,510 A * 10/1971 Lowry 229/116.2
D228,772 S * 10/1973 Hicks D9/629

D296,871 S * 7/1988 Sato D9/629
D363,303 S * 10/1995 Winston D9/629
D404,912 S * 2/1999 Addi D3/238
D457,096 S * 5/2002 Rosner D11/125
D523,757 S * 6/2006 Garcia et al. D9/629
D540,691 S * 4/2007 Davies D9/629
D622,024 S * 8/2010 School D99/5
D632,971 S * 2/2011 Dudek et al. D9/629
D650,582 S * 12/2011 Jamtlid D3/271.1

* cited by examiner

Primary Examiner — Sandra Morris

(74) *Attorney, Agent, or Firm* — Ladas & Parry LLP

(57) **CLAIM**

I claim the ornamental design for a food container, as shown.

DESCRIPTION

FIG. 1 is a top plan view of a food container showing my new design;
FIG. 2 is a front elevation view thereof;
FIG. 3 is a rear elevation view thereof;
FIG. 4 is a left side elevation view thereof;
FIG. 5 is a right side elevation view thereof;
FIG. 6 is a perspective view thereof in a closed condition from one angle;
FIG. 7 is a perspective view thereof in a closed condition from a second angle; and,
FIG. 8 is a perspective view in opened condition thereof.

1 Claim, 4 Drawing Sheets

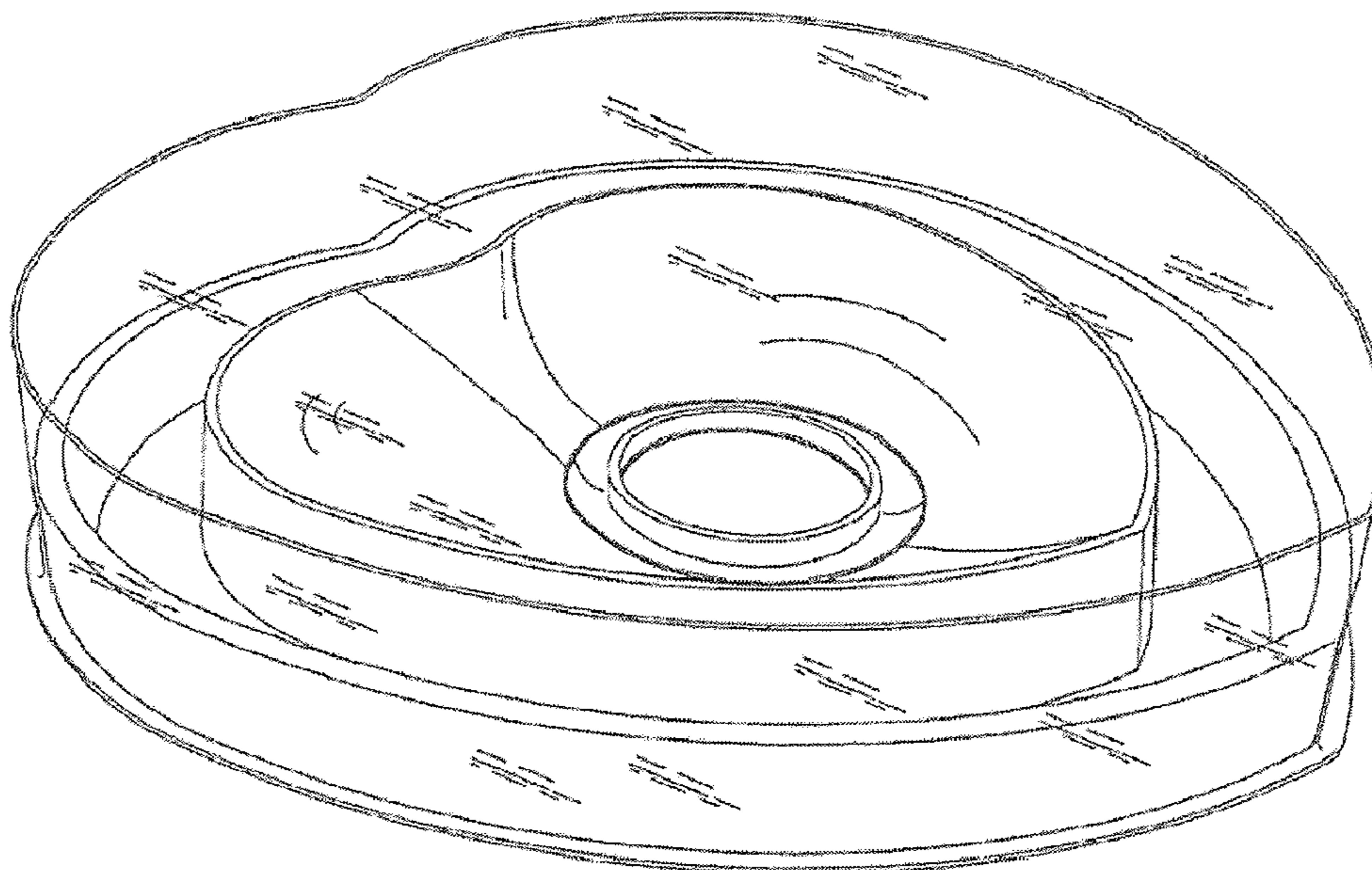

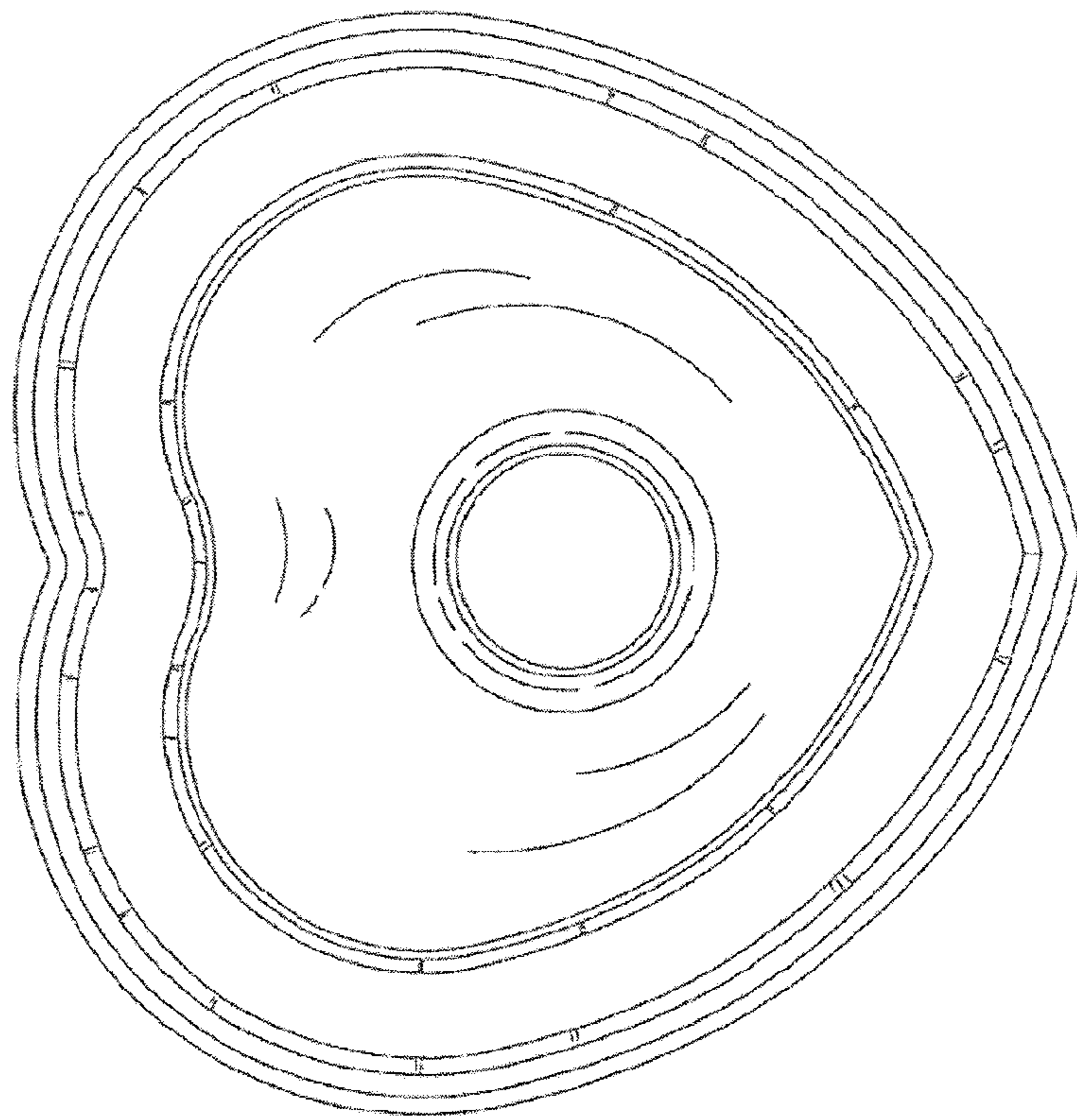

FIG. 1

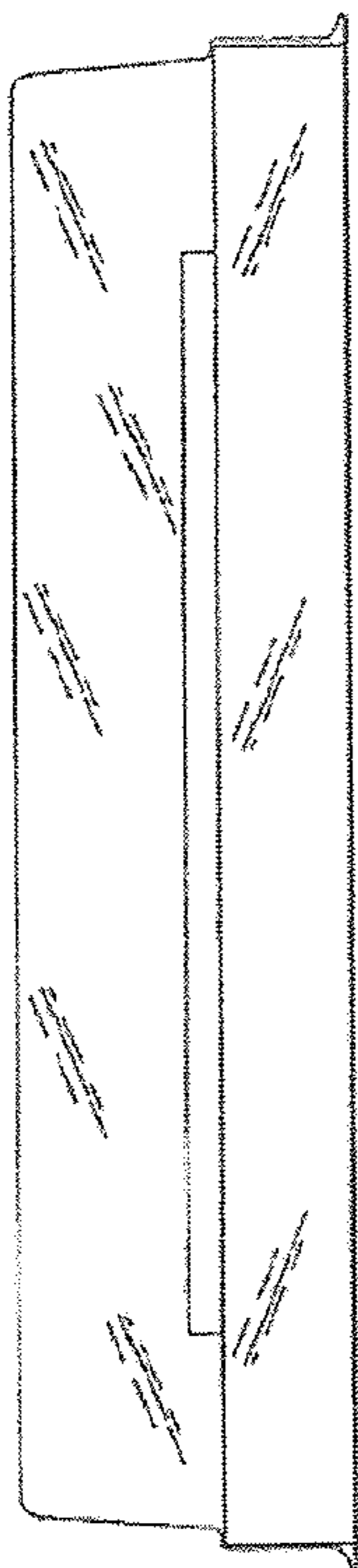

FIG. 2

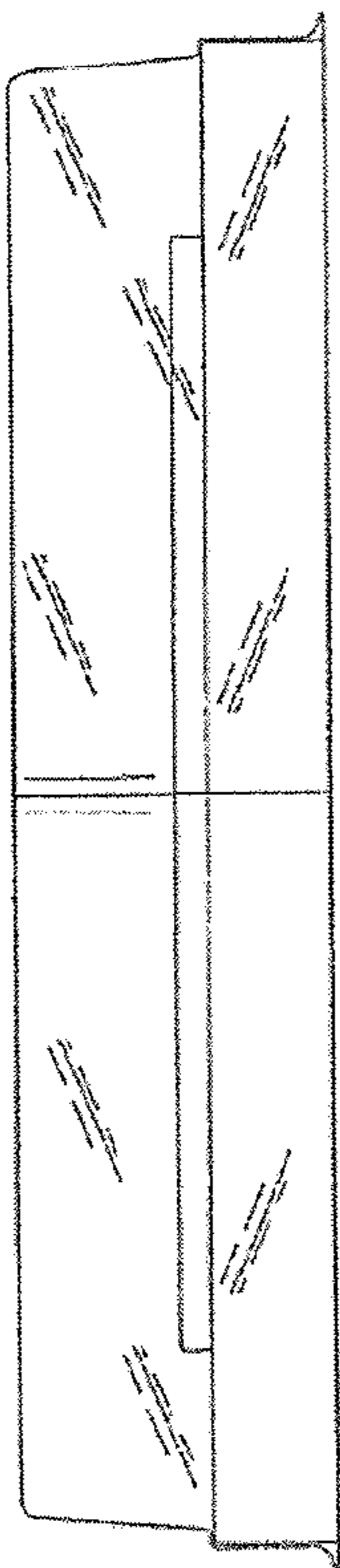

FIG. 3

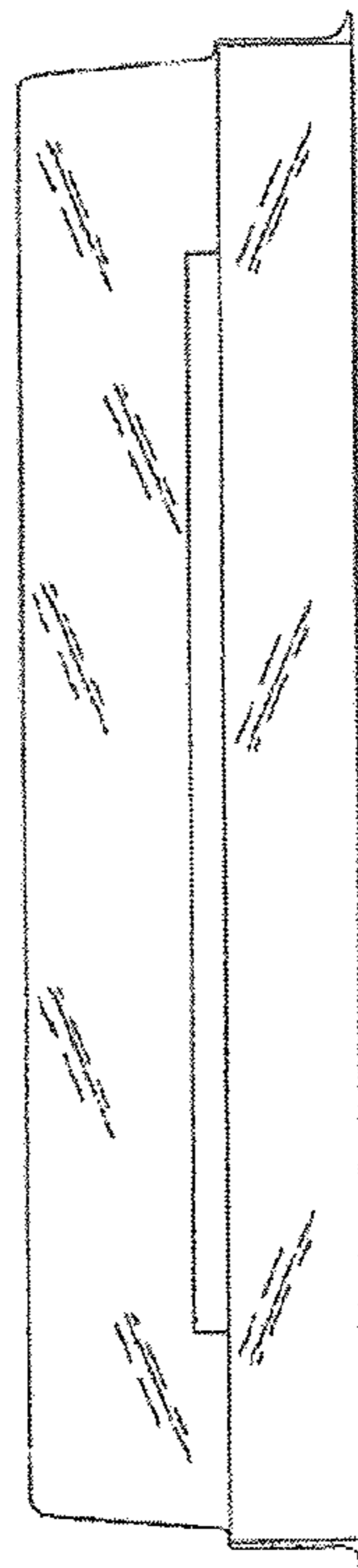

FIG. 4

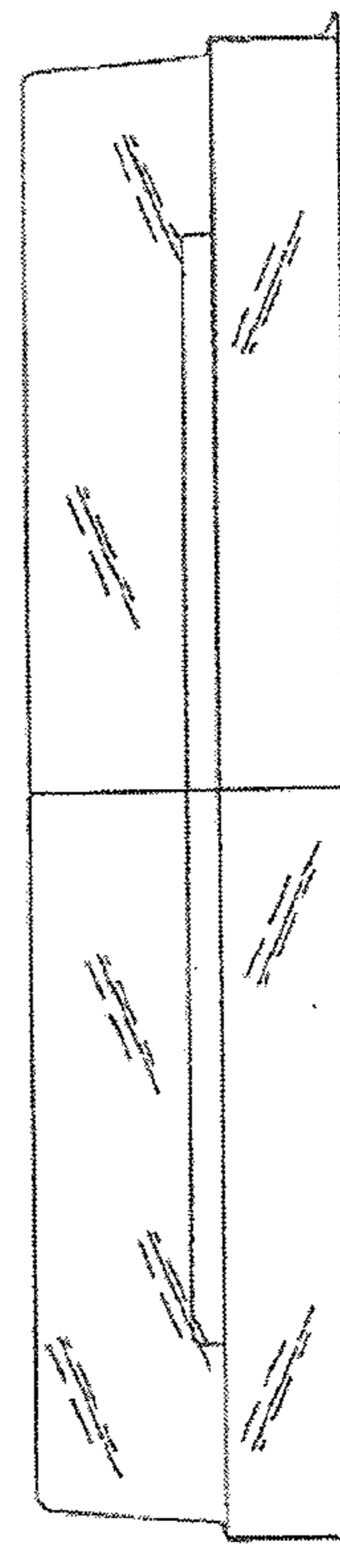

FIG. 5

FIG. 6

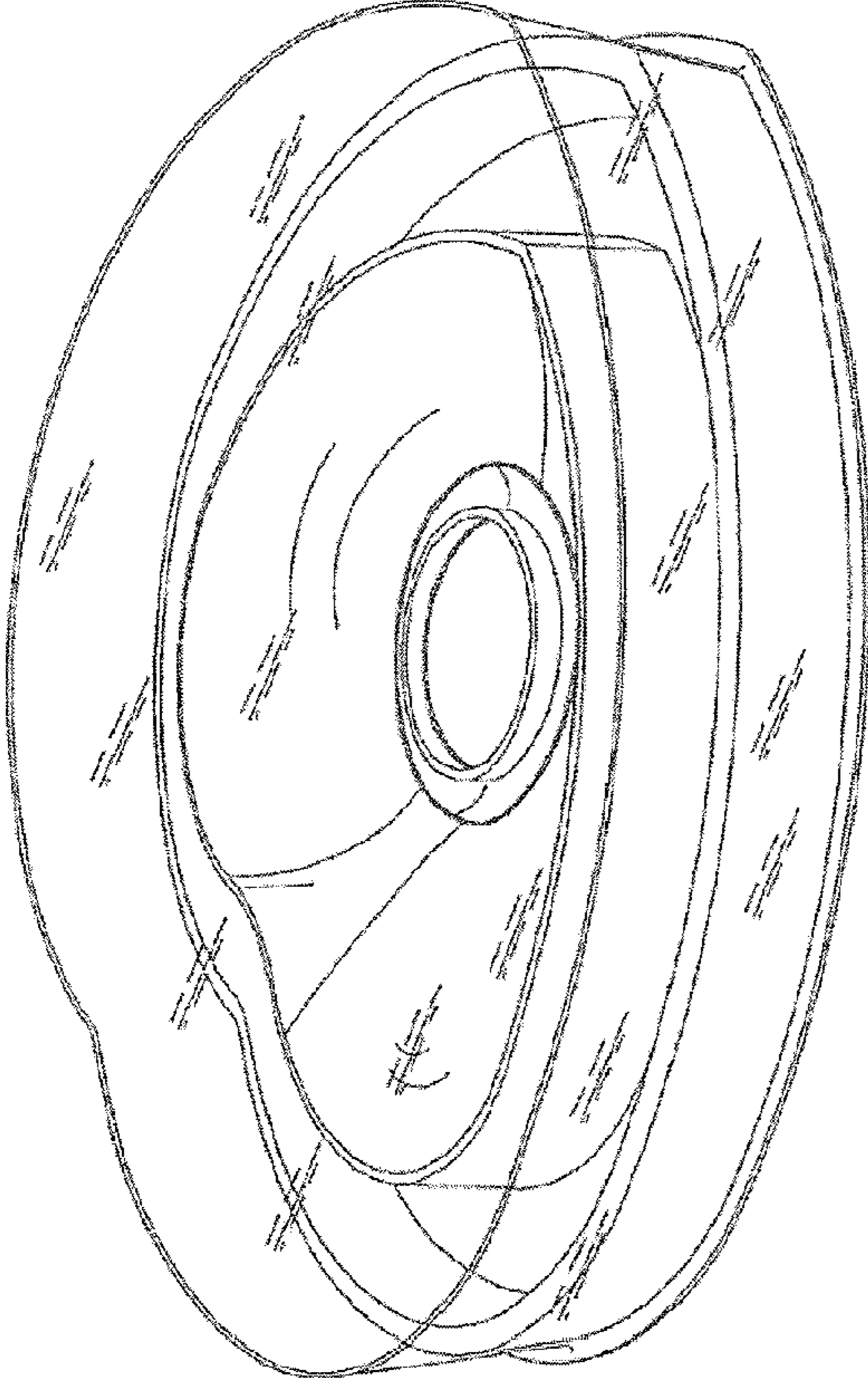

FIG. 7

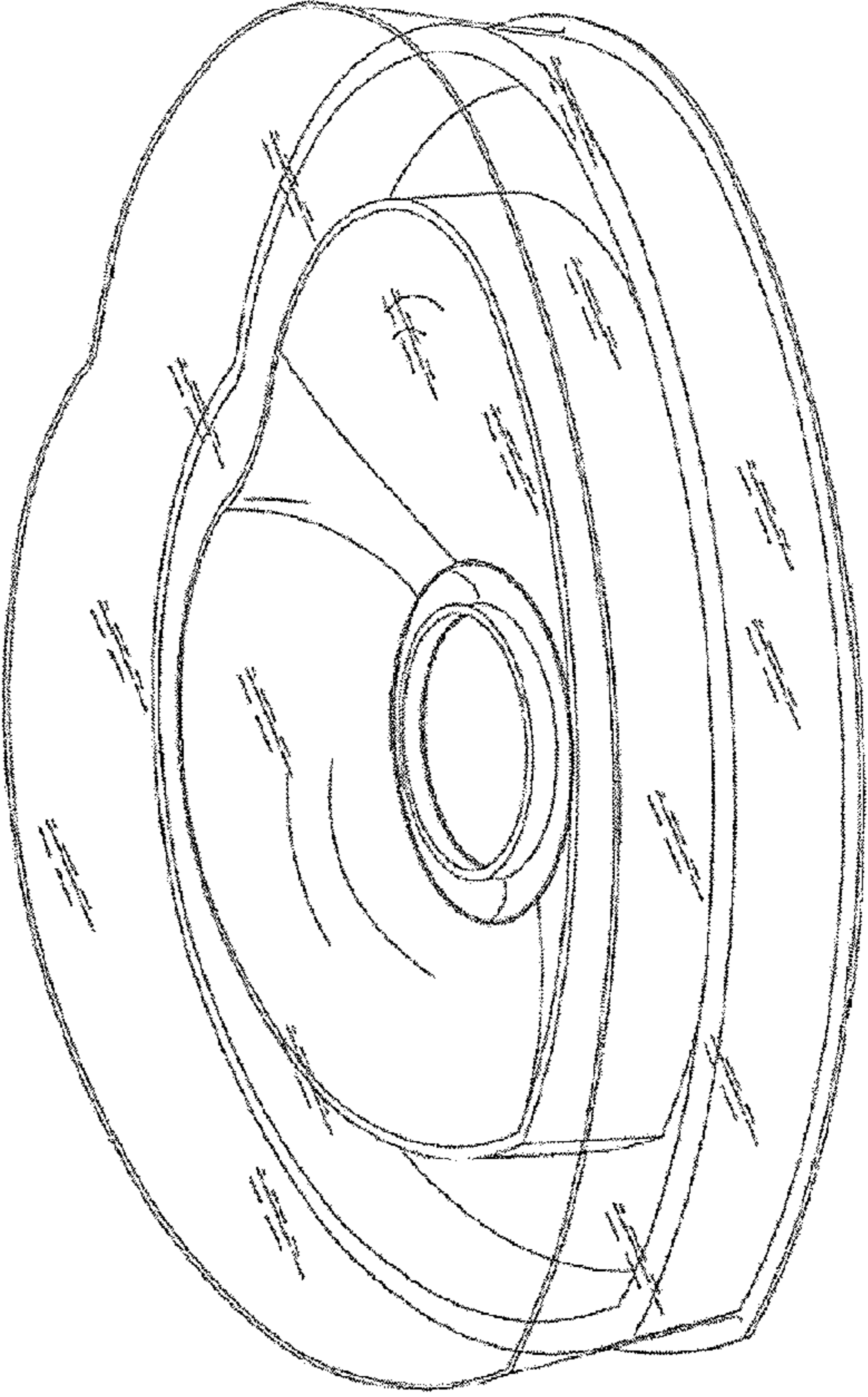

FIG. 8

