

US00D697411S

(12) **United States Design Patent**  
**Stern et al.**

(10) **Patent No.:** **US D697,411 S**  
(45) **Date of Patent:** **\*\* \*Jan. 14, 2014**

(54) **COSMETIC BOTTLE**

(75) Inventors: **Jacqueline Eisler Stern**, New York, NY (US); **Raymond Garofano**, Pelham, NY (US)

(73) Assignee: **Revlon Consumer Products Corporation**, New York, NY (US)

(\* ) Notice: This patent is subject to a terminal disclaimer.

(\*\*) Term: **14 Years**

(21) Appl. No.: **29/407,558**

(22) Filed: **Nov. 30, 2011**

**Related U.S. Application Data**

(63) Continuation-in-part of application No. 29/364,834, filed on Jun. 29, 2010, now Pat. No. Des. 651,902.

(51) **LOC (10) Cl.** ..... **09-01**

(52) **U.S. Cl.**  
USPC ..... **D9/516; D9/552**

(58) **Field of Classification Search**  
USPC ..... D9/682, 684, 686–688, 690–694, 516, D9/544–546, 549, 552, 565, 574–575; 215/379, 381–382; D28/4, 73, 76, 85, D28/88, 91.1; 220/660, 662, 665, 668–673, 220/675

See application file for complete search history.

(56) **References Cited**

**U.S. PATENT DOCUMENTS**

1,232,485 A \* 7/1917 Bloom ..... 215/382  
D66,788 S \* 3/1925 Curran ..... D9/551

(Continued)

**OTHER PUBLICATIONS**

“DNA Perfume” (1993), by Bijan, A Collector’s Handbook of Miniature Perfume Bottles: Minis, Mates, and More. by Jeri Lyn Ringblum, Schiffer Publishing Ltd., Atglen, PA, © 1996, pp. 41-42, 2 images.\*

(Continued)

*Primary Examiner* — Carol P Rademaker

(74) *Attorney, Agent, or Firm* — Revlon Consumer Products Corporation

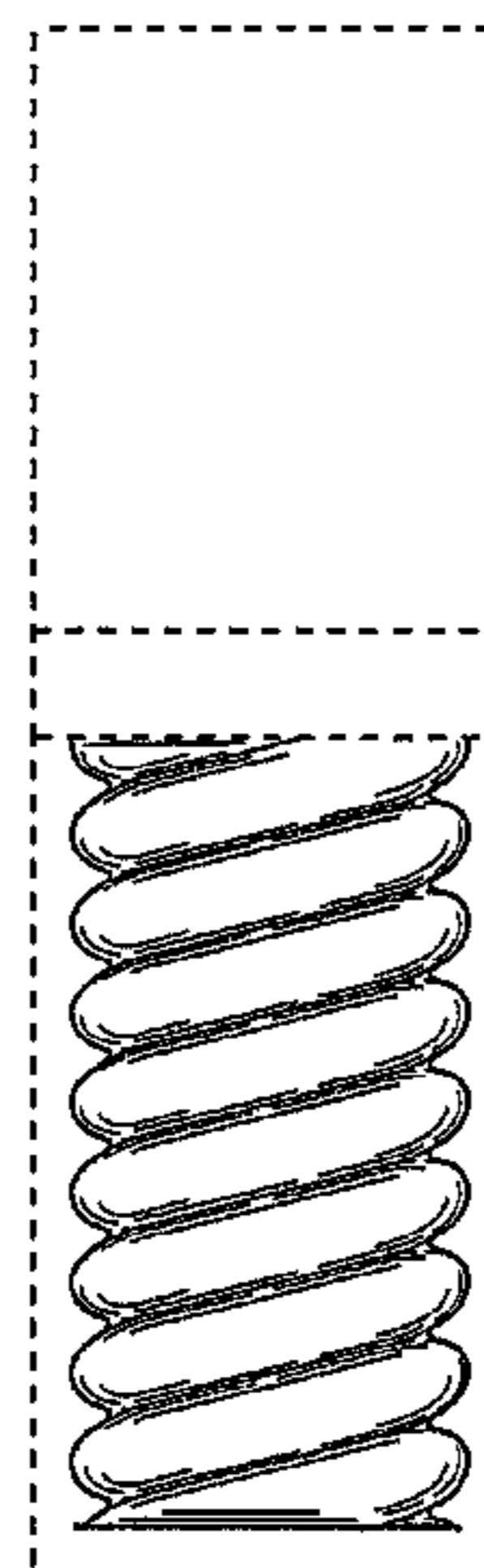
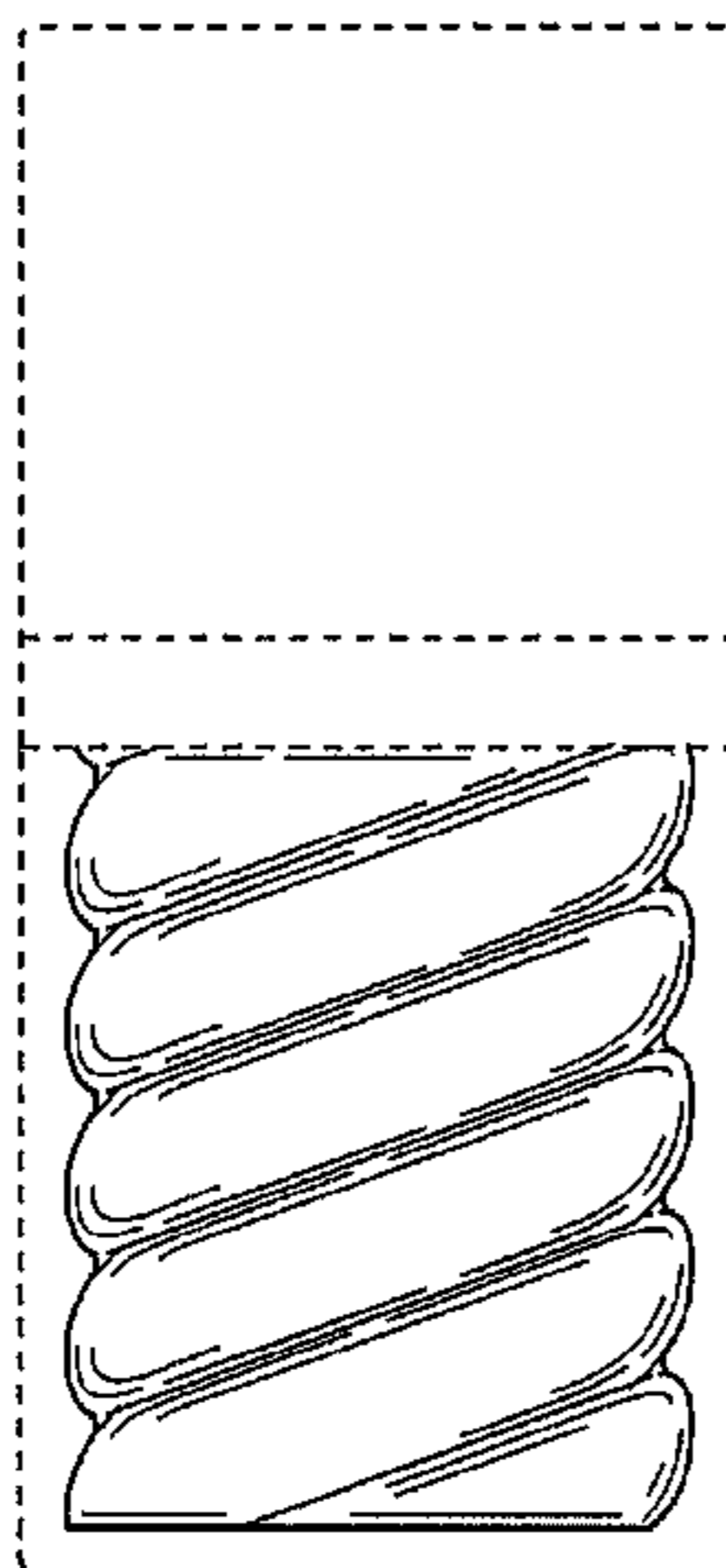
(57) **CLAIM**

The ornamental design for a cosmetic bottle, as shown and described.

**DESCRIPTION**

FIG. 1 is a front perspective view of the cosmetic bottle. FIG. 2 is a front view of the cosmetic bottle shown in FIG. 1. FIG. 3 is a right side elevation view of the cosmetic bottle shown in FIG. 1. FIG. 4 is a top view of the cosmetic bottle shown in FIG. 1. FIG. 5 is a bottom view of the cosmetic bottle shown in FIG. 1. FIG. 6 is a front perspective view of a second embodiment of a cosmetic bottle. FIG. 7 is a front view of the cosmetic bottle shown in FIG. 6. FIG. 8 is a right side elevation view of the cosmetic bottle shown in FIG. 6. FIG. 9 is a top view of the cosmetic bottle shown in FIG. 6. FIG. 10 is a bottom view of the cosmetic bottle shown in FIG. 6. FIG. 11 is a front perspective view of a third embodiment of a cosmetic bottle. FIG. 12 is a front view of the cosmetic bottle shown in FIG. 11. FIG. 13 is a right side view of the cosmetic bottle shown in FIG. 11. FIG. 14 is a top view of the cosmetic bottle shown in FIG. 11. FIG. 15 is a bottom view of the cosmetic bottle shown in FIG. 11. FIG. 16 is a front perspective view of a fourth embodiment of a cosmetic bottle. FIG. 17 is a front view of the cosmetic bottle shown in FIG. 16. FIG. 18 is a right side view of the cosmetic bottle shown in FIG. 16. FIG. 19 is a top view of the cosmetic bottle shown in FIG. 16; and, FIG. 20 is a bottom view of the cosmetic bottle shown in FIG. 16.

**1 Claim, 8 Drawing Sheets**



(56)

**References Cited**

U.S. PATENT DOCUMENTS

D116,017 S \* 8/1939 Buckingham ..... D9/552  
 D135,569 S \* 4/1943 Buckingham ..... D9/544  
 D140,741 S \* 4/1945 Serra ..... D9/552 X  
 D183,294 S \* 7/1958 Van-Zeller ..... D9/552  
 D187,345 S \* 3/1960 Fuerst ..... D9/552  
 D250,574 S \* 12/1978 Boyle ..... D9/537  
 D265,971 S \* 8/1982 Kaufmann ..... D9/552  
 D306,261 S \* 2/1990 Rader ..... D9/552  
 D319,183 S \* 8/1991 Halm ..... D9/552  
 D320,671 S \* 10/1991 Hoenig ..... D28/7  
 D336,821 S \* 6/1993 Ancona et al. .... D7/596  
 D369,069 S \* 4/1996 Husted ..... D7/679  
 D376,035 S \* 11/1996 Boucheron ..... D28/91.1  
 D403,244 S \* 12/1998 Van Dyk et al. .... D9/538 X  
 D420,284 S \* 2/2000 Sagel ..... D9/552 X  
 D423,722 S \* 4/2000 Lang ..... D28/76  
 D430,493 S \* 9/2000 Weick ..... D9/537  
 D447,422 S \* 9/2001 Peek ..... D9/574 X

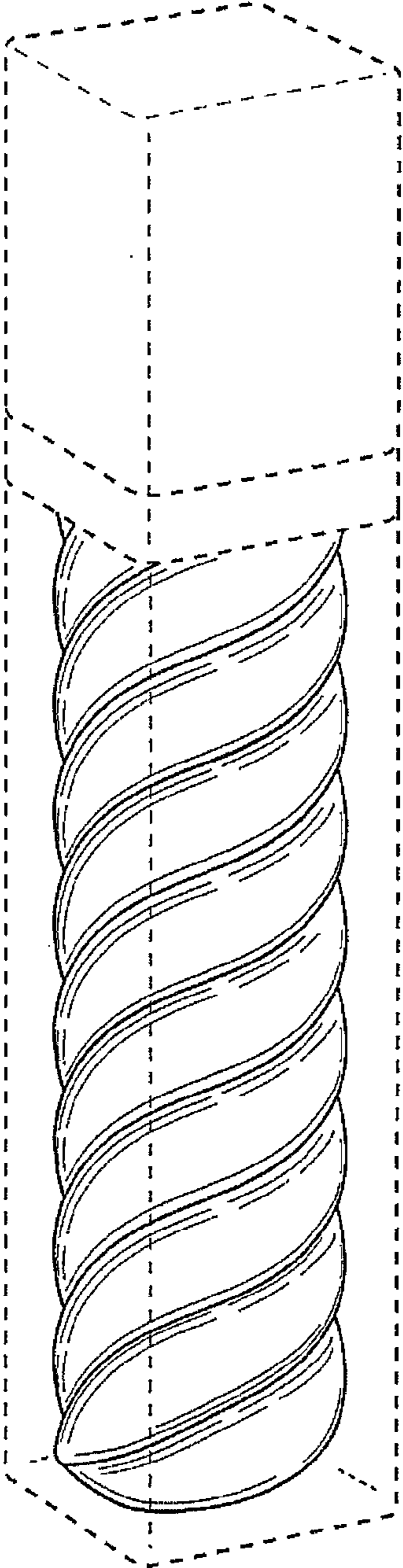
D448,281 S \* 9/2001 Thibiant et al. .... D9/688  
 D450,590 S \* 11/2001 Van Dyk et al. .... D9/552 X  
 D457,066 S \* 5/2002 Weick ..... D9/538 X  
 D486,036 S \* 2/2004 Chuang ..... D7/529  
 D536,582 S \* 2/2007 Roth et al. .... D7/629  
 D573,883 S \* 7/2008 Zboch et al. .... D9/565 X  
 D614,963 S \* 5/2010 Arnell ..... D9/537  
 D618,110 S \* 6/2010 Arnell ..... D9/538 X  
 D619,897 S \* 7/2010 Arnell ..... D9/516  
 D620,367 S \* 7/2010 Leslie et al. .... D9/549 X  
 D626,852 S \* 11/2010 Kruetzkamp et al. .... D9/553  
 D634,212 S \* 3/2011 Kruetzkamp et al. .... D9/690

OTHER PUBLICATIONS

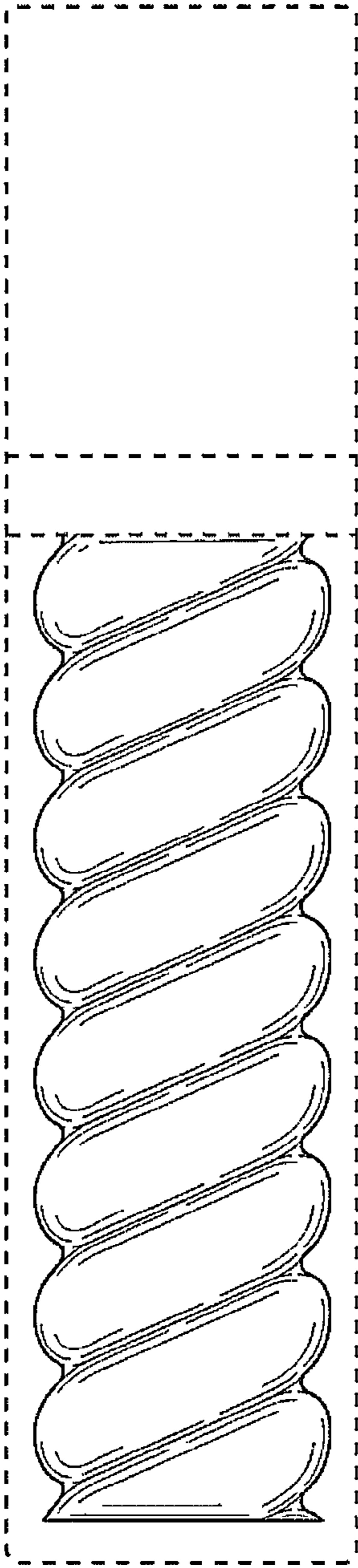
World Wide Packaging LLC Advertisement. Keeping You a Step Ahead. Beauty Packaging. Apr./May 2010 Issue. p. 31.  
 FragranceNetcom. DNA by Bijan, Circa 1993. [http://www.fragrancenet.com/f/net/product\\_pop.html?sku=134292](http://www.fragrancenet.com/f/net/product_pop.html?sku=134292). Last visited: Jun. 29, 2010.

\* cited by examiner

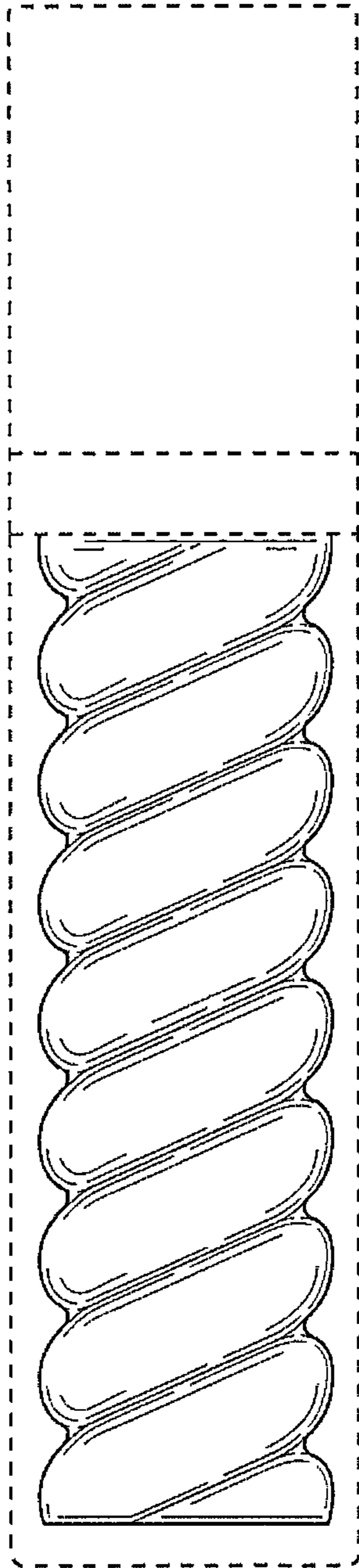
**FIG. 1**



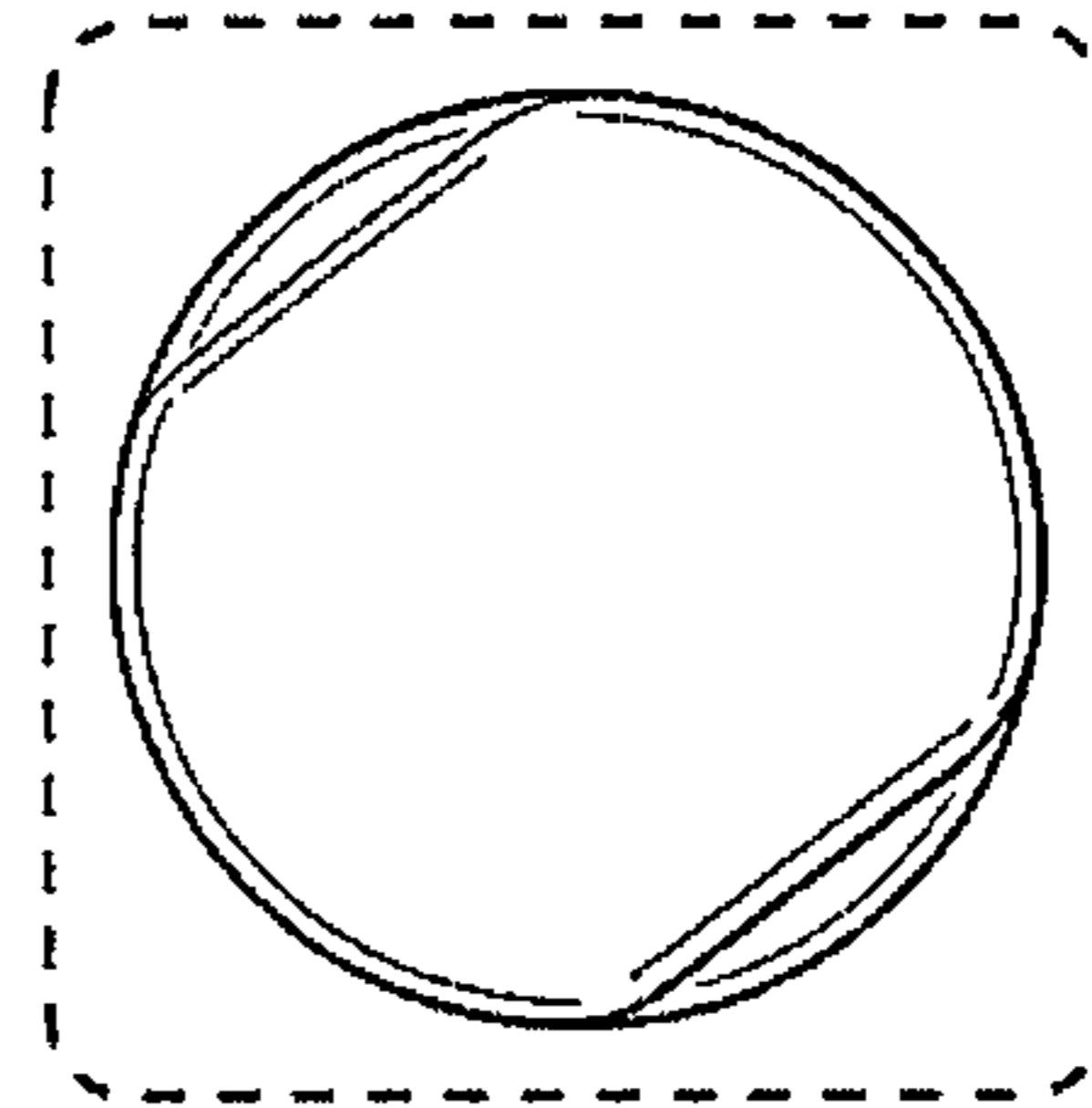
**FIG. 2**



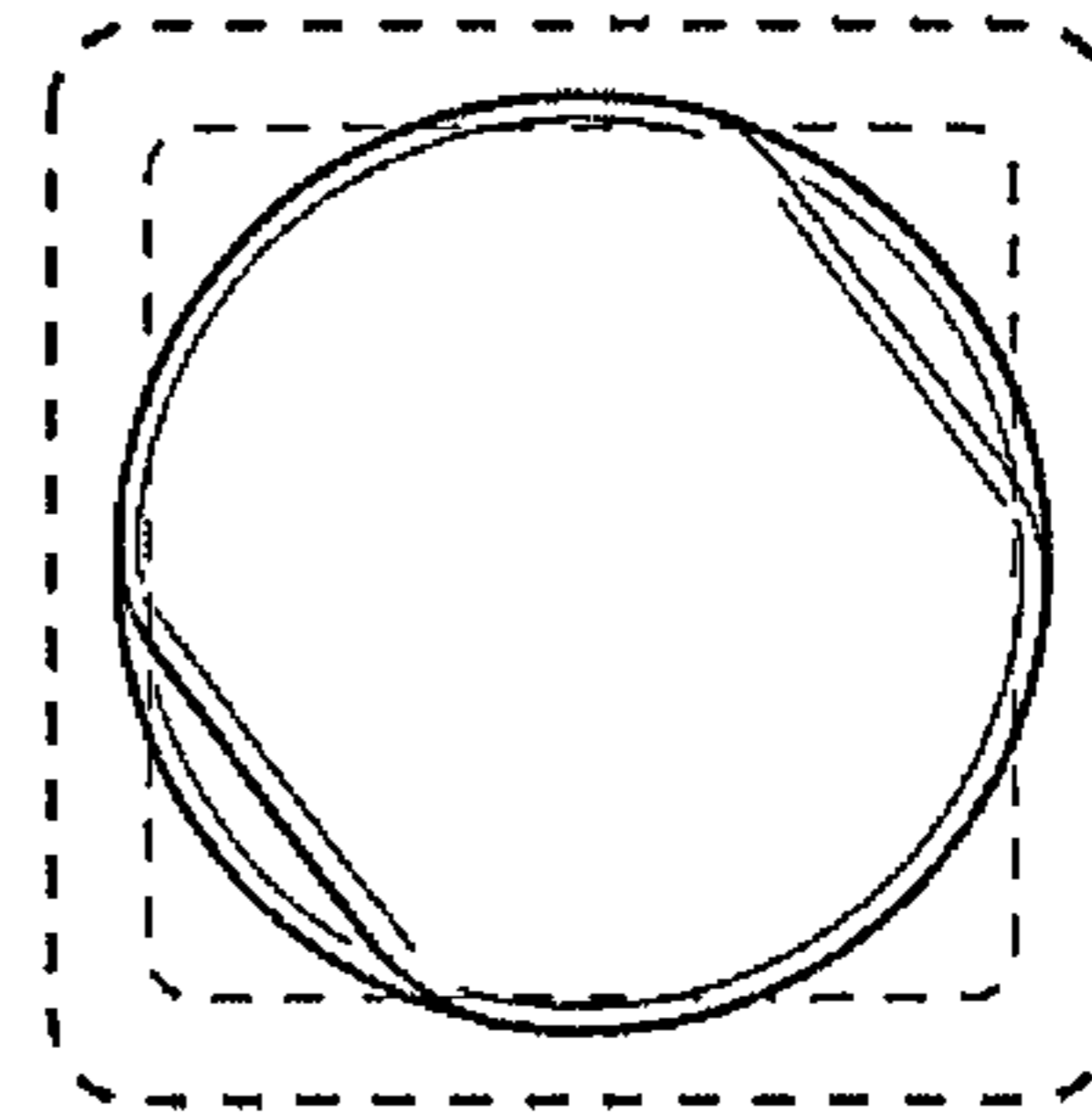
**FIG. 3**



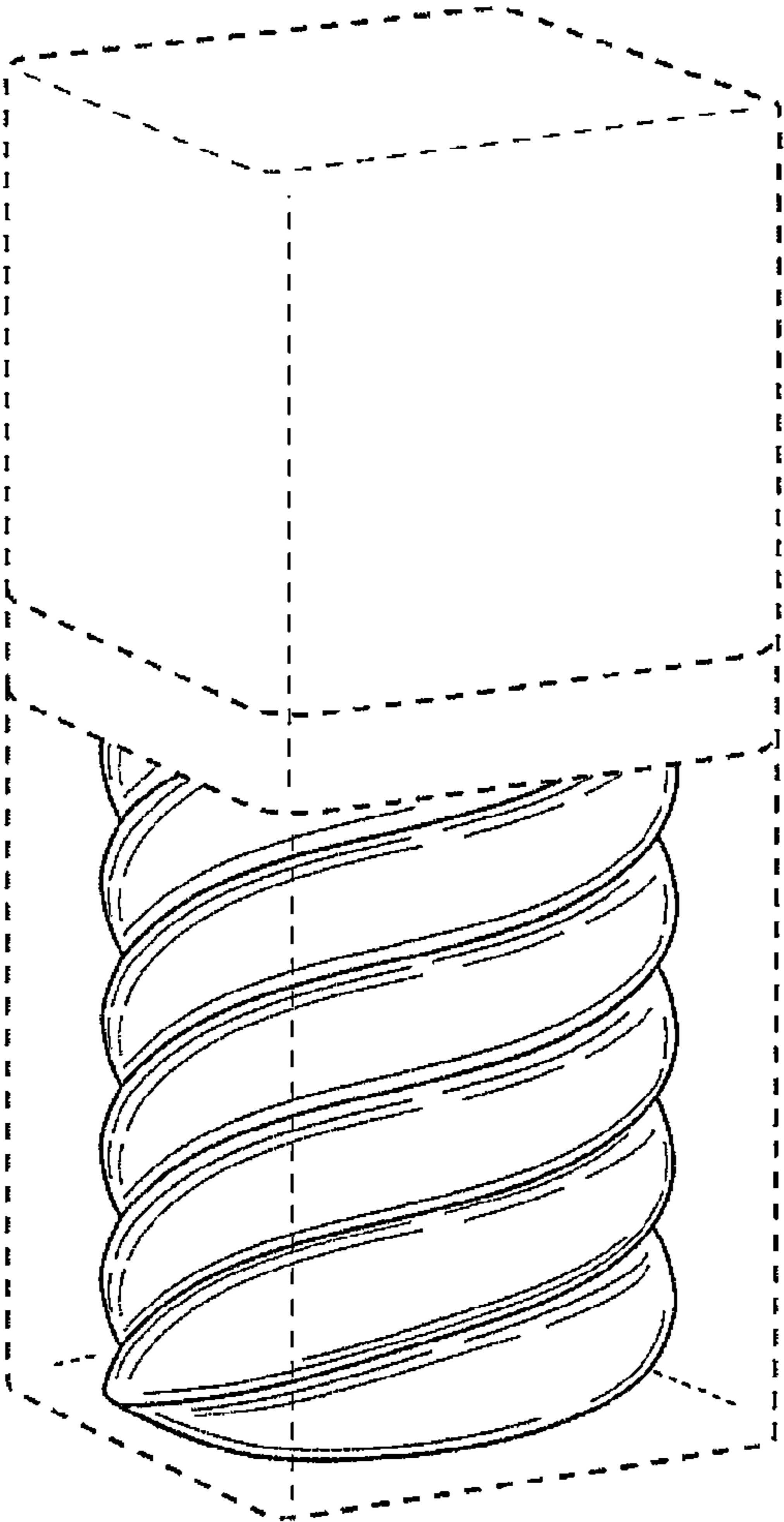
**FIG. 4**



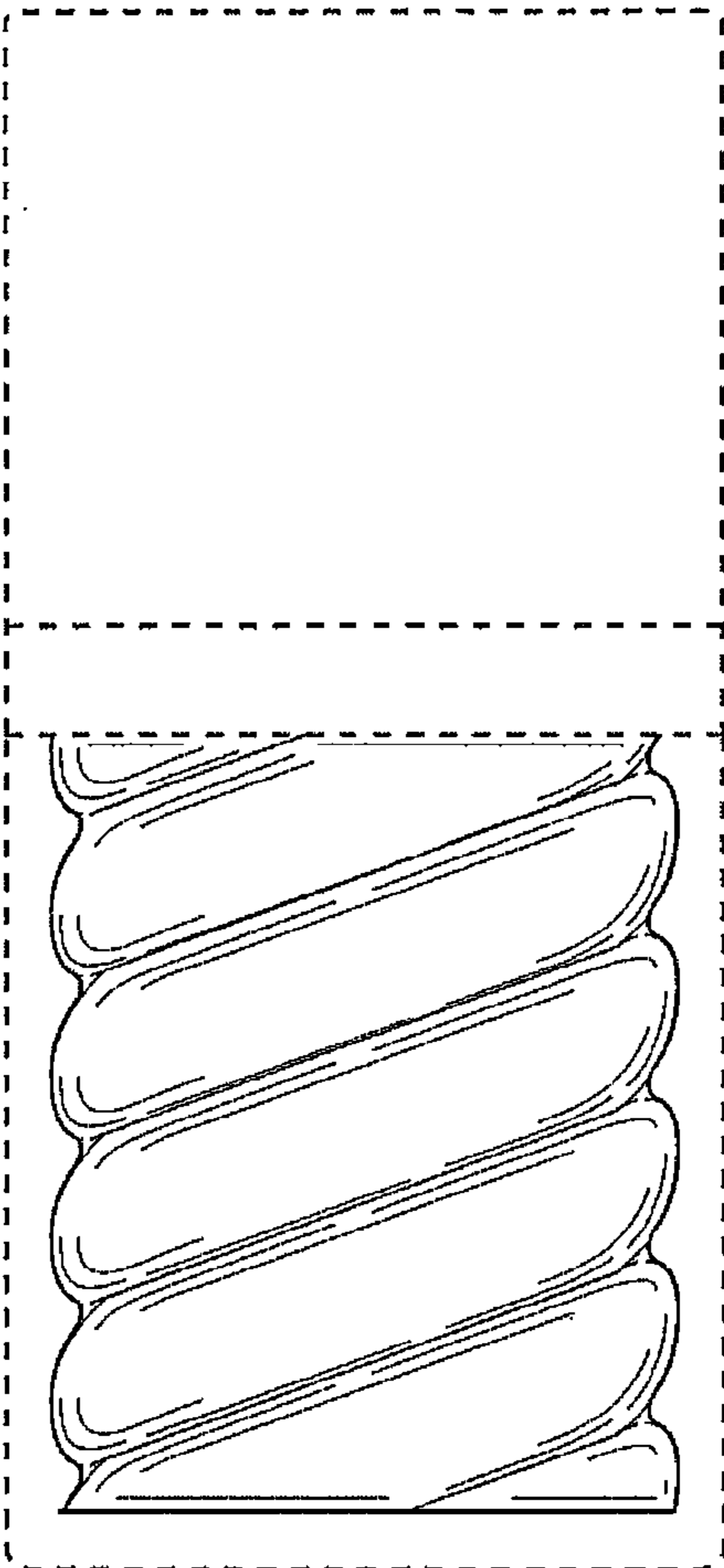
**FIG. 5**



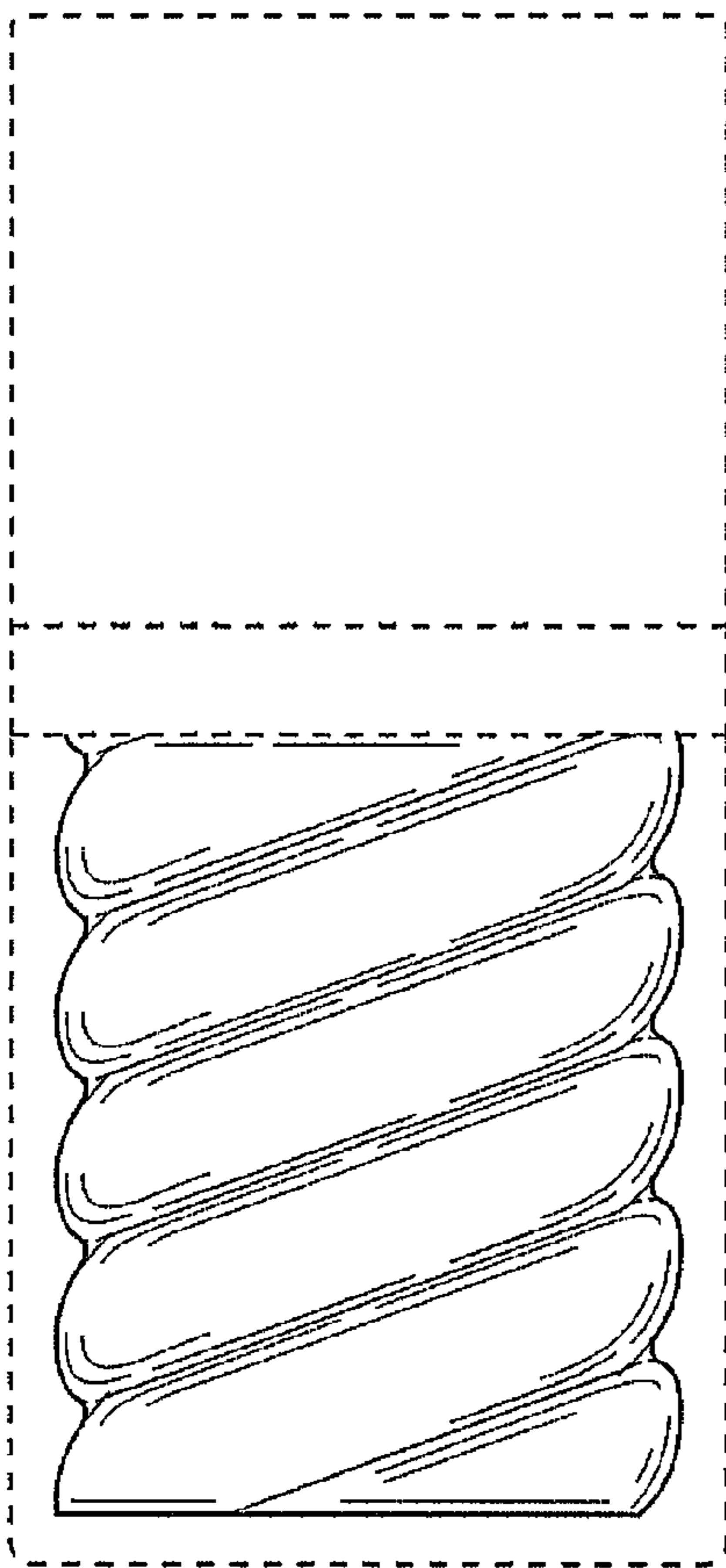
**FIG. 6**



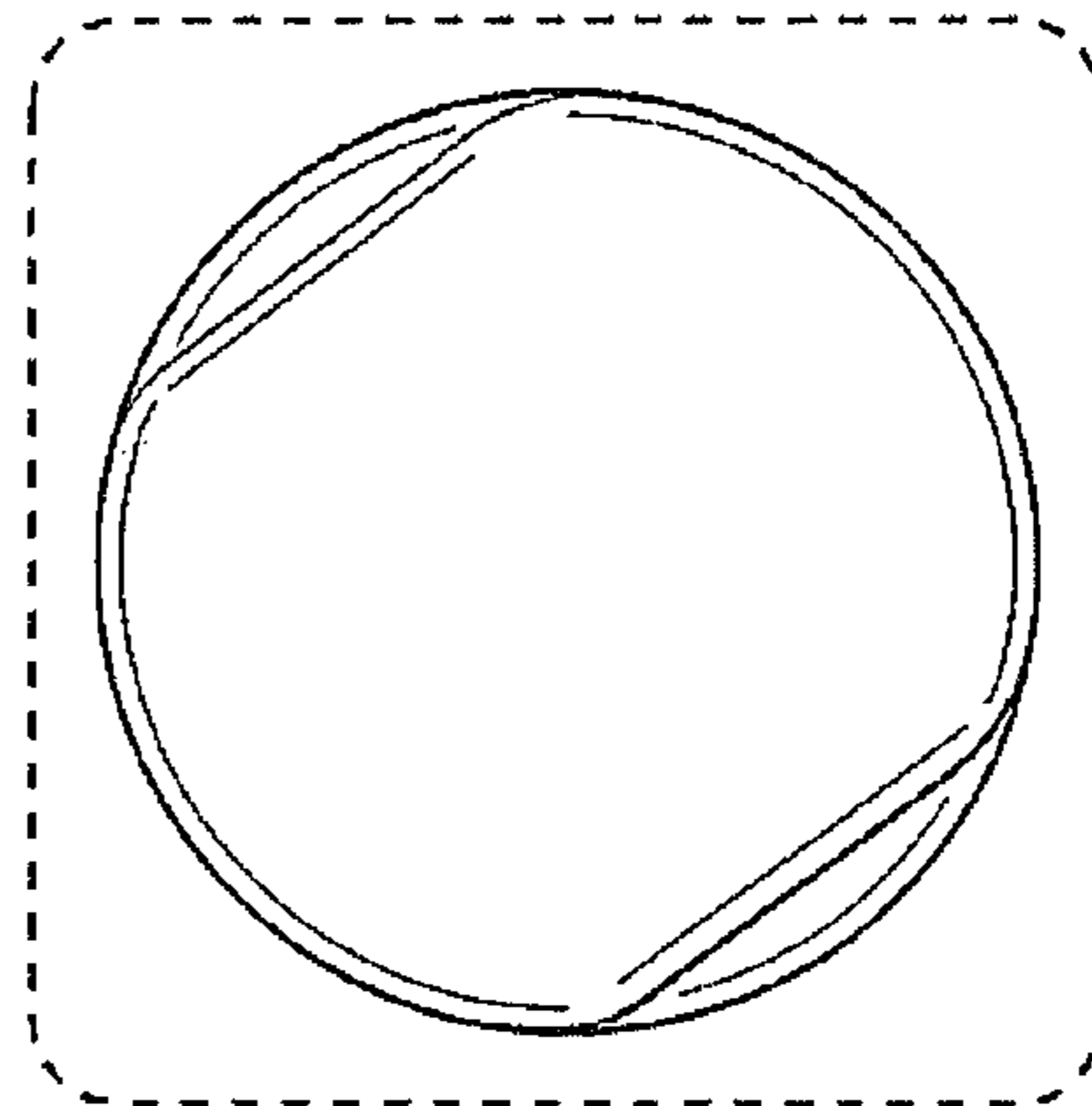
**FIG. 7**



**FIG. 8**



**FIG. 9**



**FIG. 10**

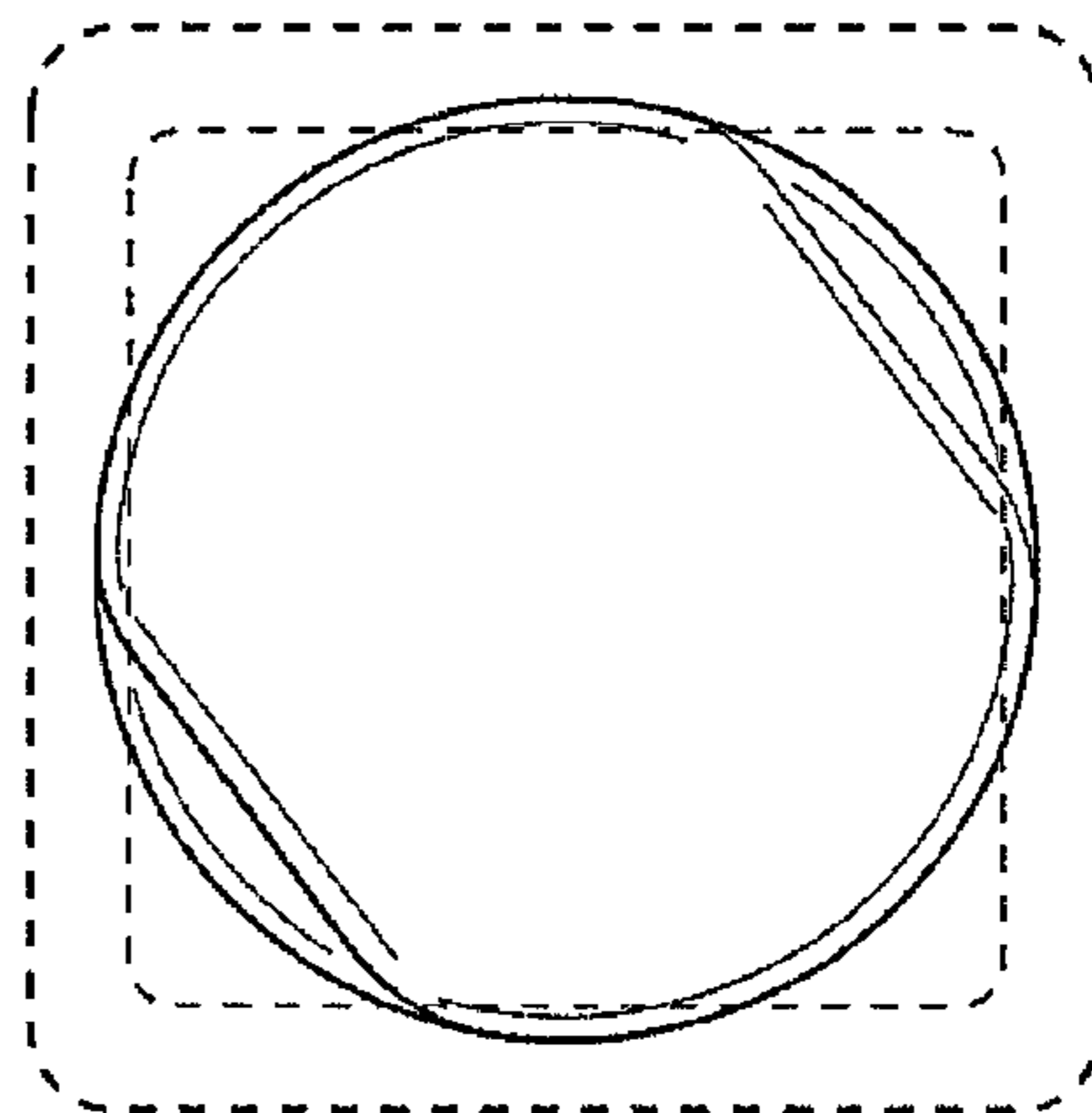


FIG. 11

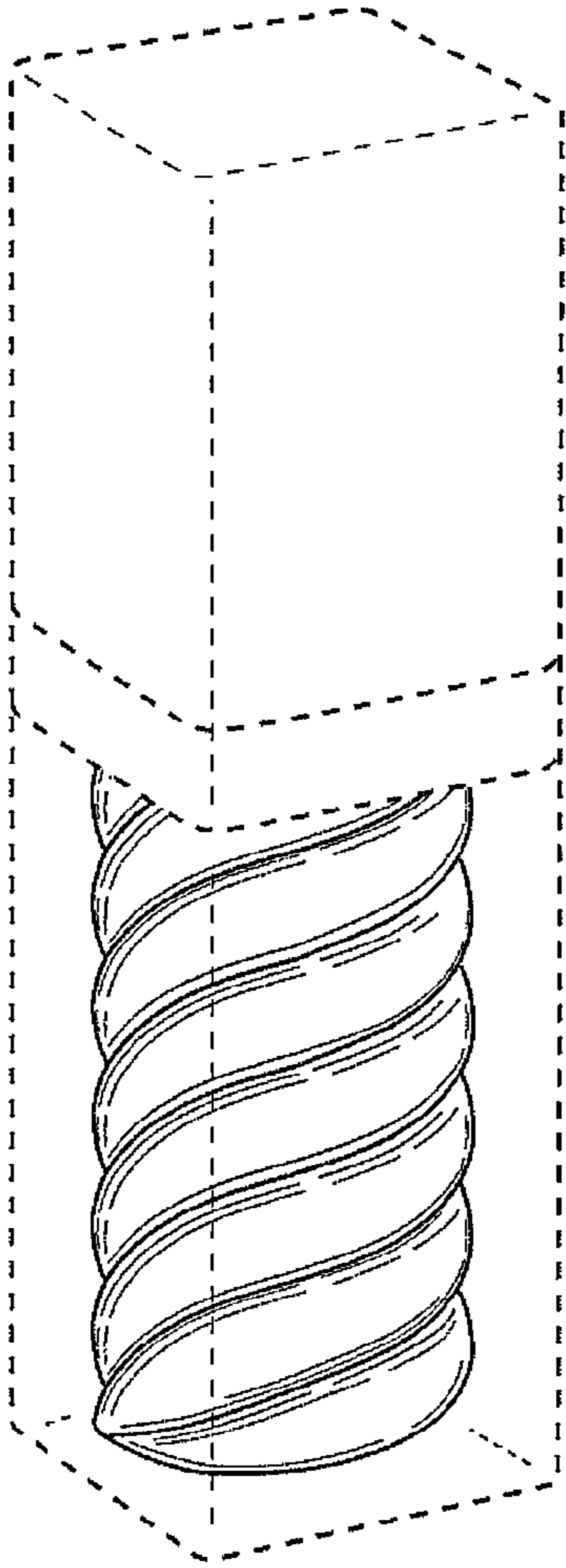
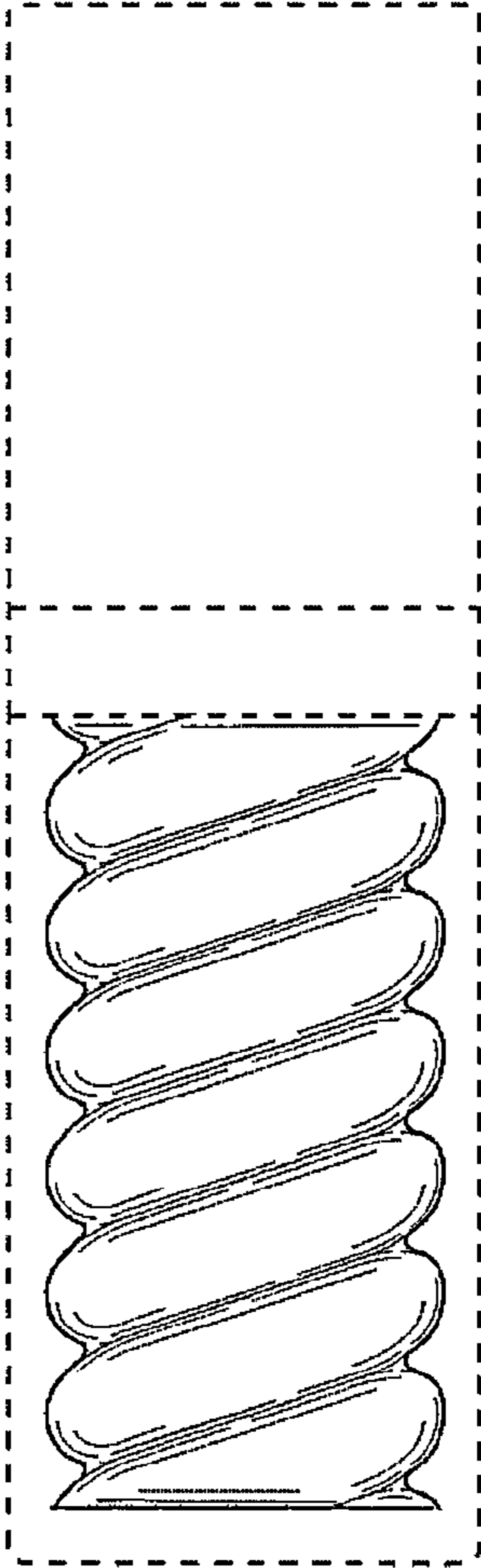
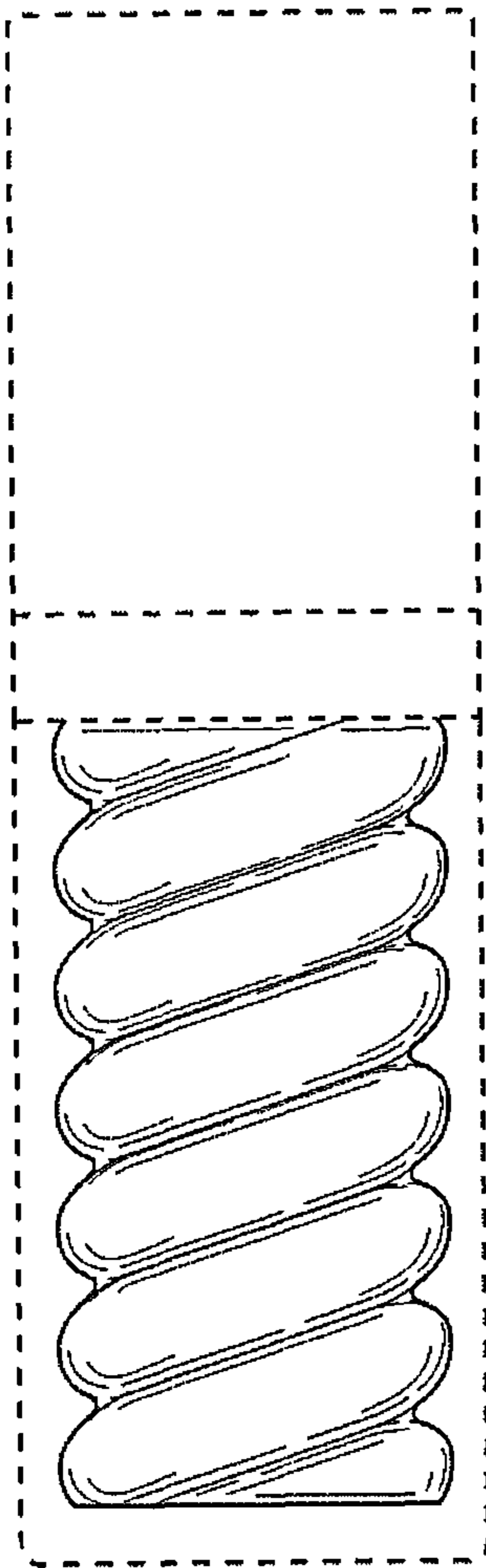


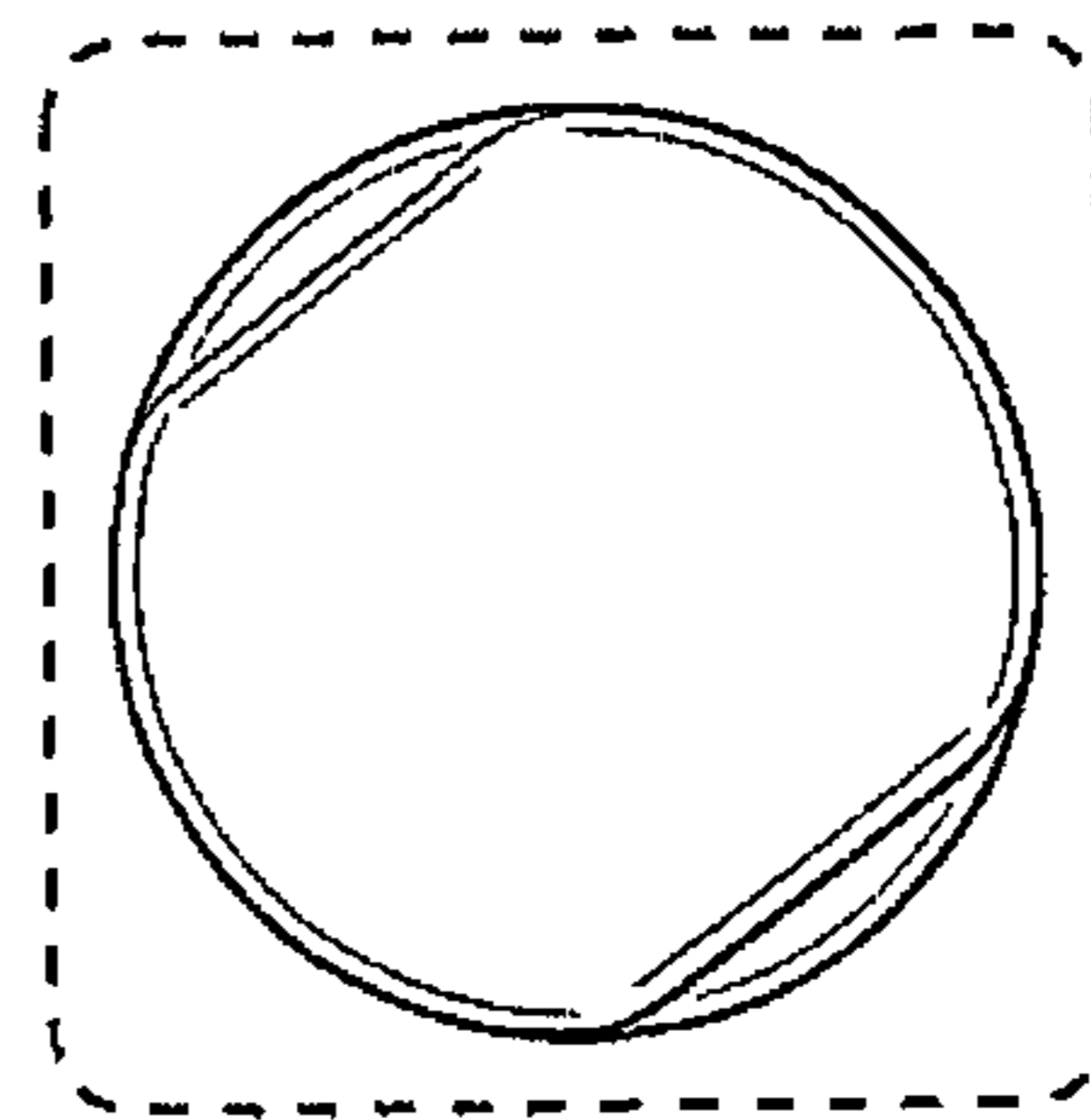
FIG. 12



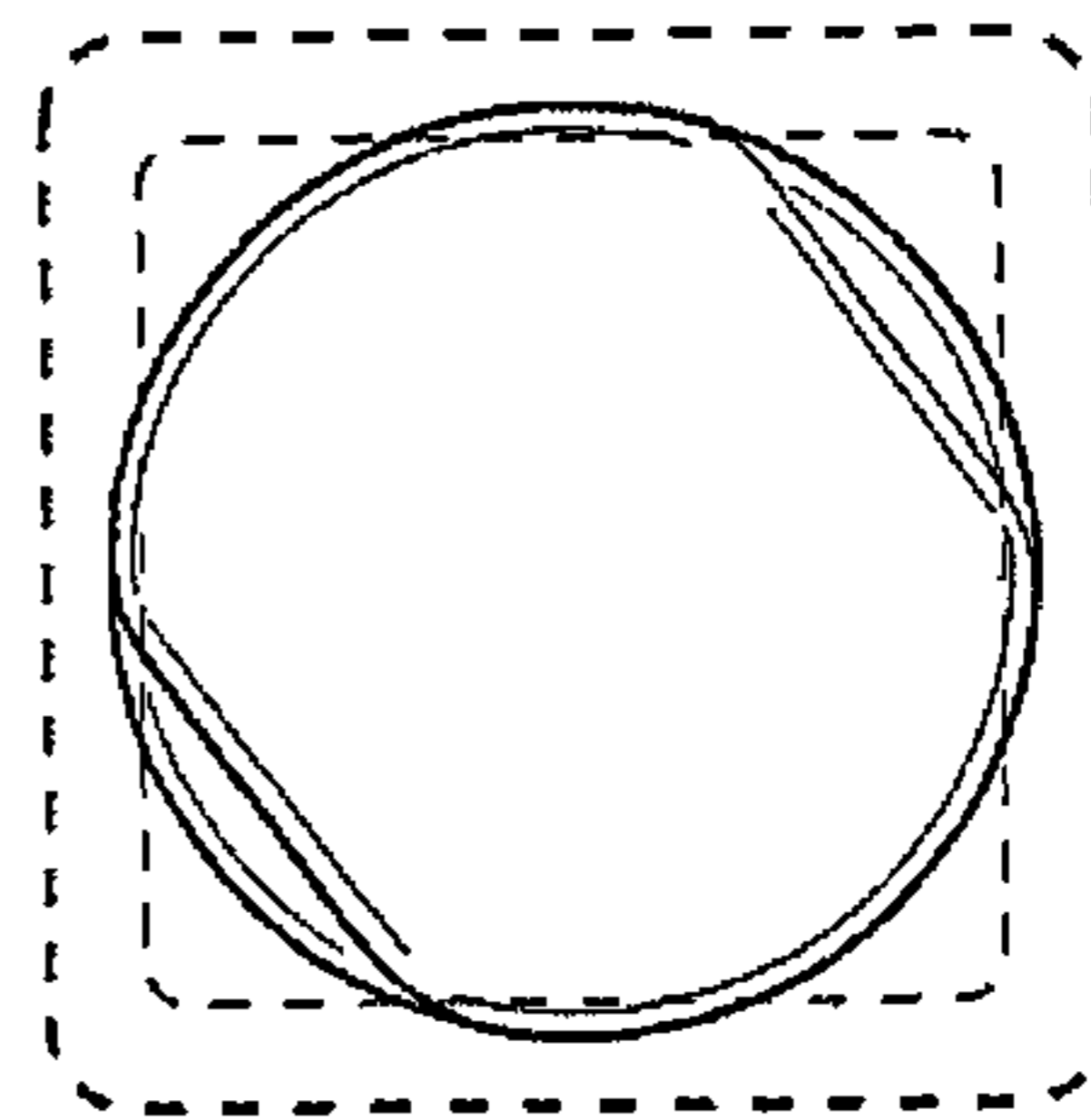
**FIG. 13**



**FIG. 14**

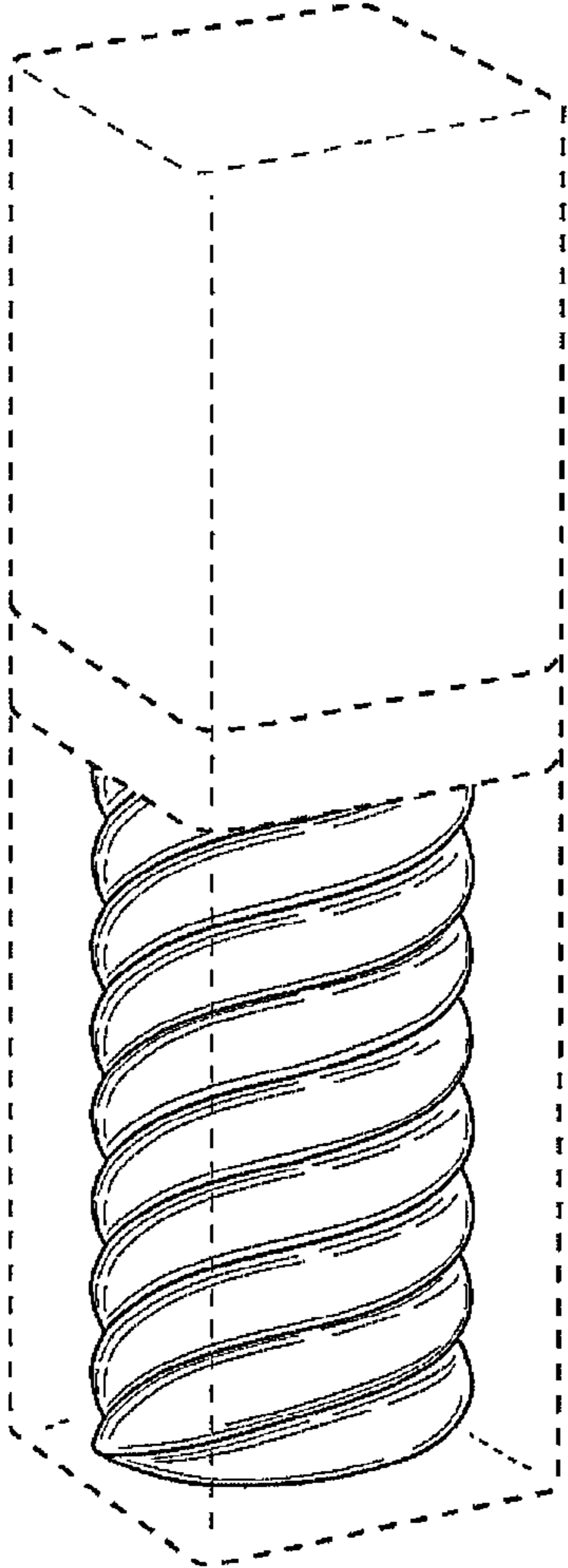


**FIG. 15**

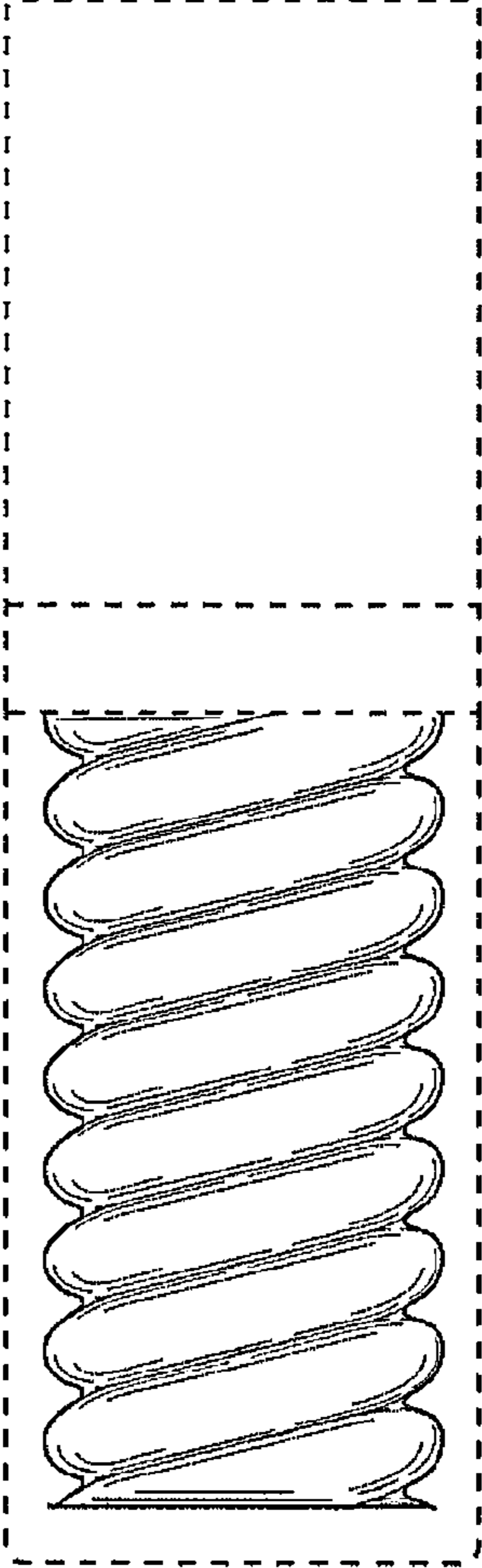




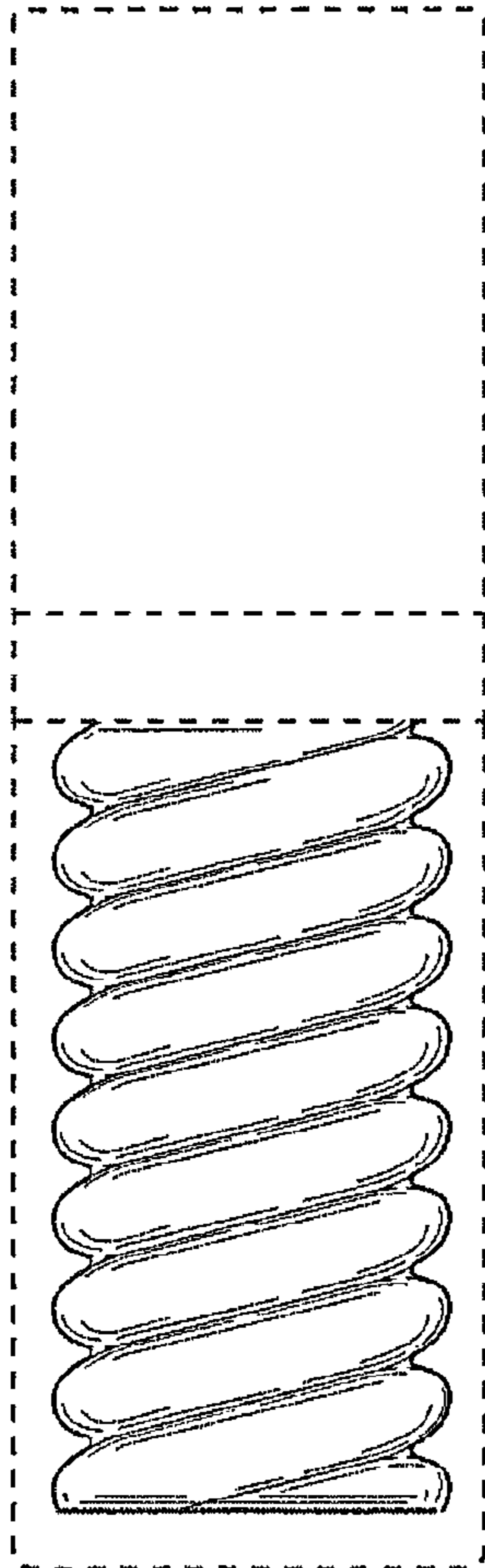
**FIG. 16**



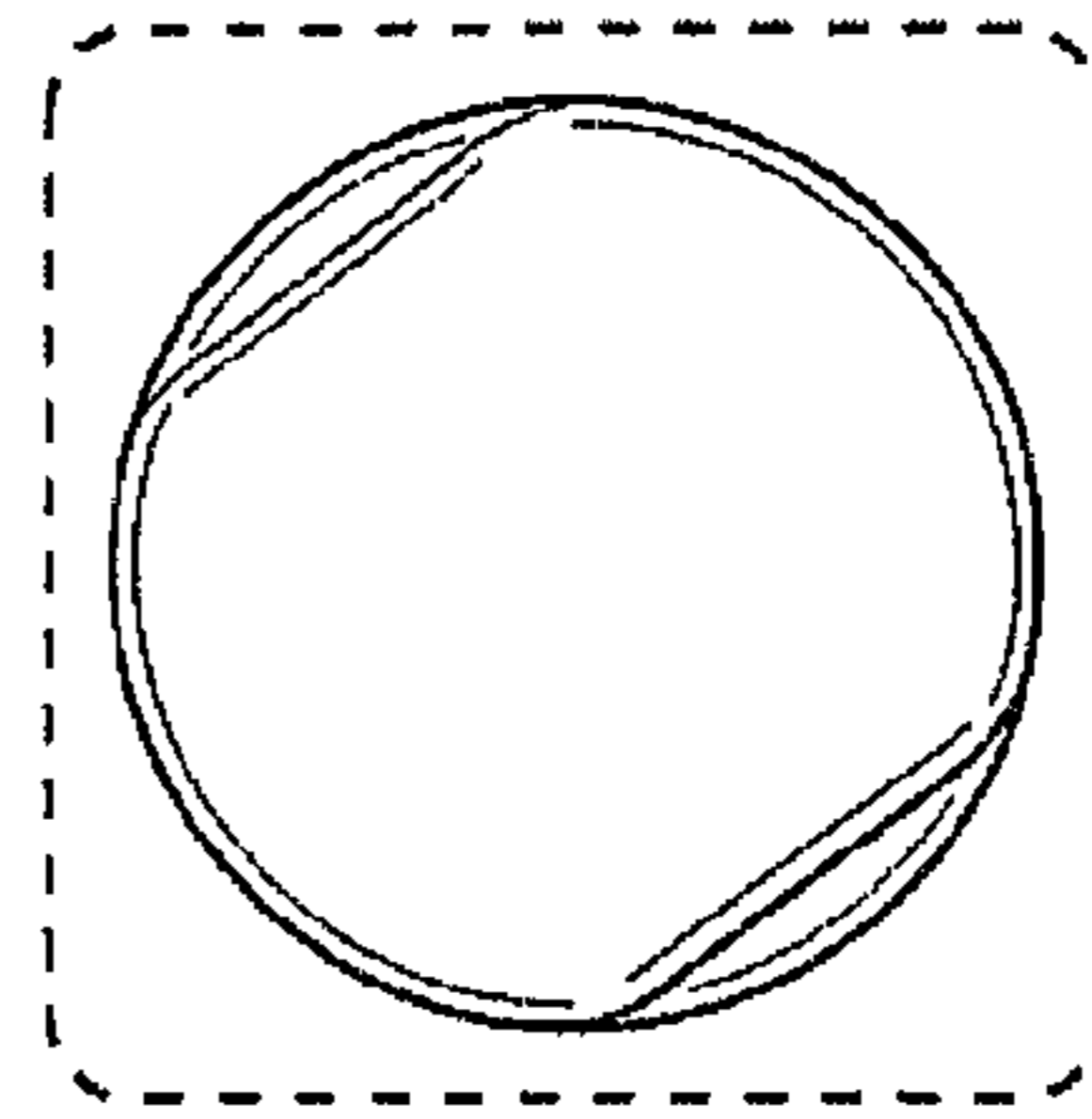
**FIG. 17**



**FIG. 18**



**FIG. 19**



**FIG. 20**

