



US00D697397S

(12) **United States Design Patent**
Goodman et al.

(10) **Patent No.:** **US D697,397 S**
(45) **Date of Patent:** **** Jan. 14, 2014**

(54) **MAGNET CLIP**
(75) Inventors: **Sheldon H. Goodman**, Solon, OH (US);
Phaysouk Xayoiphonh, Akron, OH
(US); **Grace Lee**, Mayfield, OH (US)
(73) Assignee: **Spectrum Diversified Designs, Inc.**,
Streetsboro, OH (US)
(**) Term: **14 Years**

D387,381 S	12/1997	Littmann	
D404,071 S	1/1999	Shyu	
D409,881 S	5/1999	Lai	
D411,085 S	6/1999	Biber	
D497,637 S	10/2004	Cetera	
D550,551 S	9/2007	Howard	
7,391,365 B2 *	6/2008	Wang et al.	342/357.46
D608,630 S	1/2010	Goodman et al.	
D634,794 S *	3/2011	Rappaport-Rowan	D21/606
D648,618 S *	11/2011	Goodman et al.	D8/367
D672,935 S *	12/2012	Khan	D99/5

* cited by examiner

(21) Appl. No.: **29/417,544**

Primary Examiner — John Windmuller

(22) Filed: **Apr. 5, 2012**

(74) *Attorney, Agent, or Firm* — Pearne & Gordon LLP

(51) **LOC (10) Cl.** **08-08**

(57) **CLAIM**

(52) **U.S. Cl.**

The ornamental design for a magnet clip, as shown and described.

USPC **D8/395**

(58) **Field of Classification Search**

DESCRIPTION

USPC D8/394–396, 72, 367, 373; D19/56, 65,
D19/86; 24/67.3; D32/60–64; D28/40
See application file for complete search history.

FIG. 1 is a perspective view of a magnet clip showing our new design;

(56) **References Cited**

U.S. PATENT DOCUMENTS

D19,504 S	12/1889	Cox et al.
D140,240 S	2/1945	Martinelli
D246,356 S	11/1977	Fox
5,027,439 A	7/1991	Spector
D321,008 S	10/1991	Cheng
5,322,718 A	6/1994	Low

FIG. 2 is a top plan view thereof;

FIG. 3 is a front elevational view thereof;

FIG. 4 is a side elevational view thereof;

FIG. 5 is a rear elevational view thereof; and,

FIG. 6 is a bottom plan view thereof.

The dotted line showing in the drawings, illustrates environmental matter and forms no part of the claimed design.

1 Claim, 3 Drawing Sheets

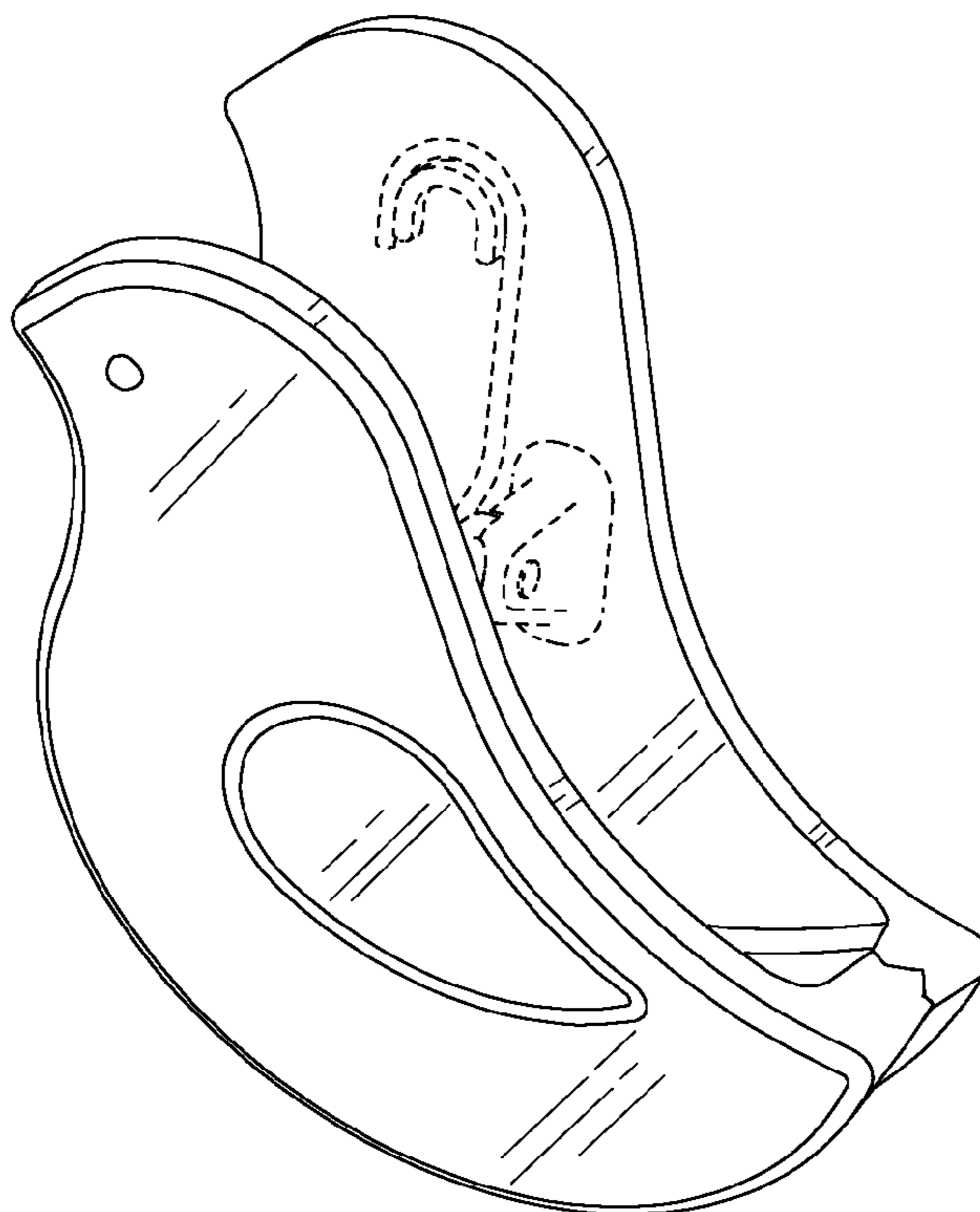

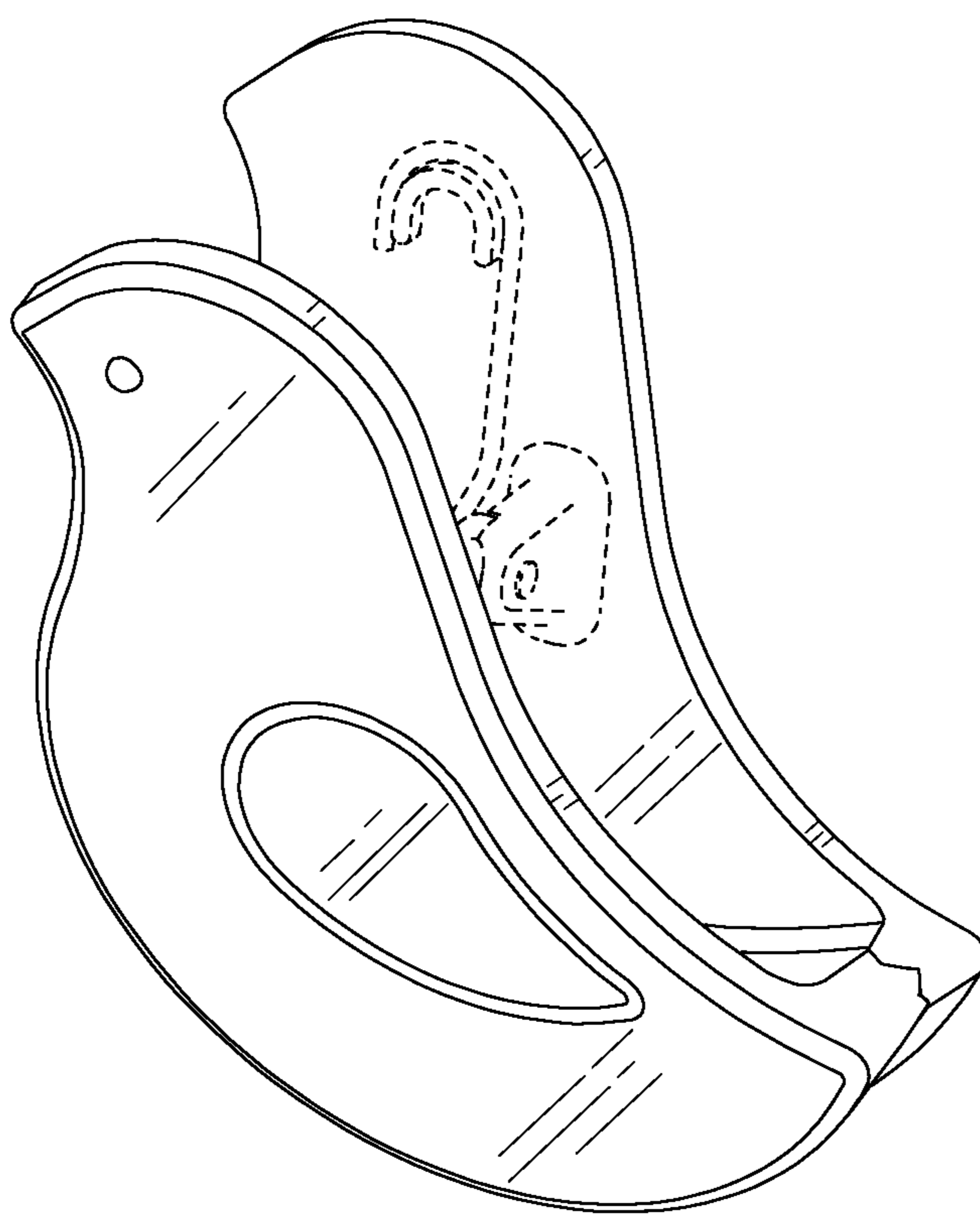

FIG. 1

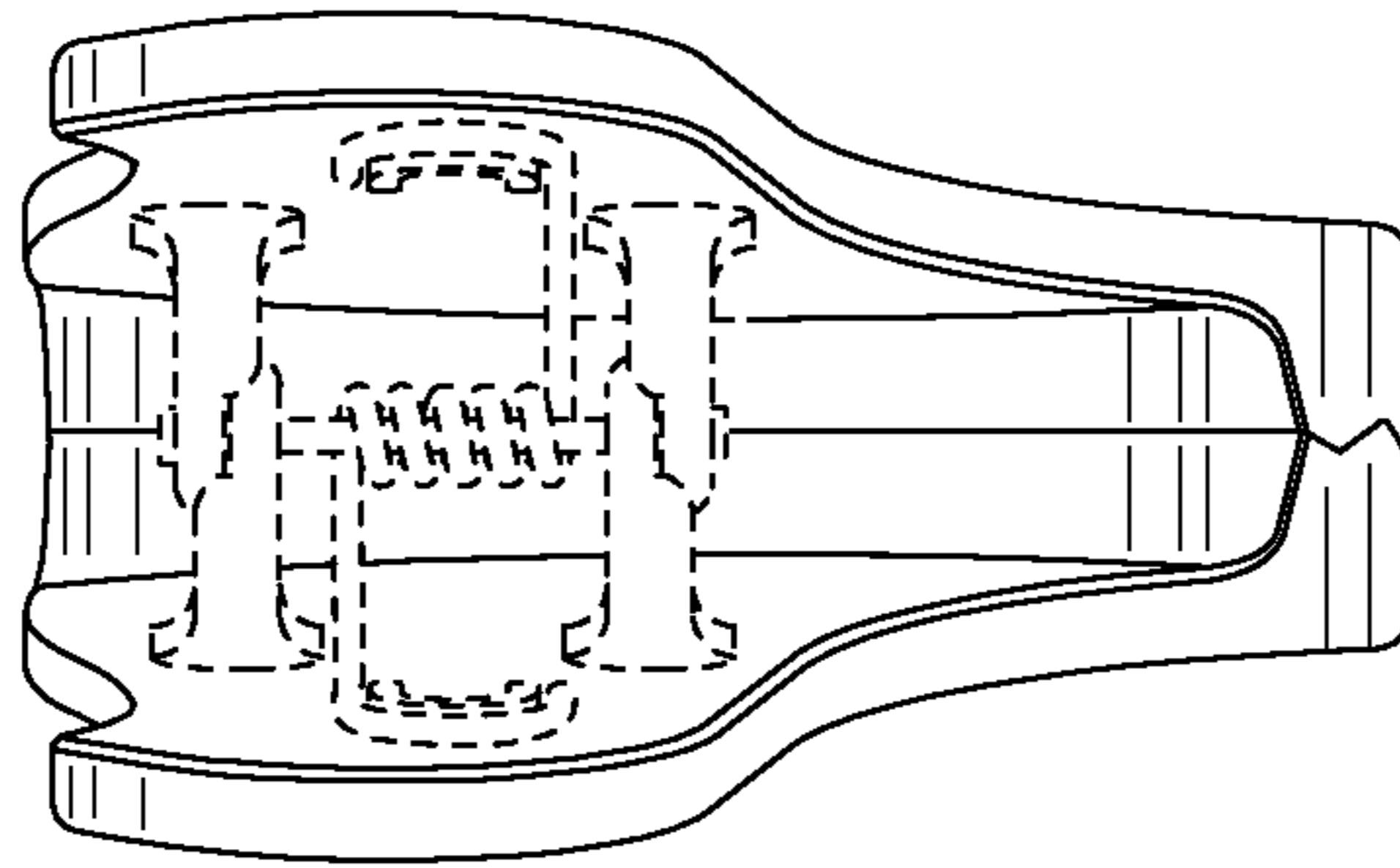

FIG. 2

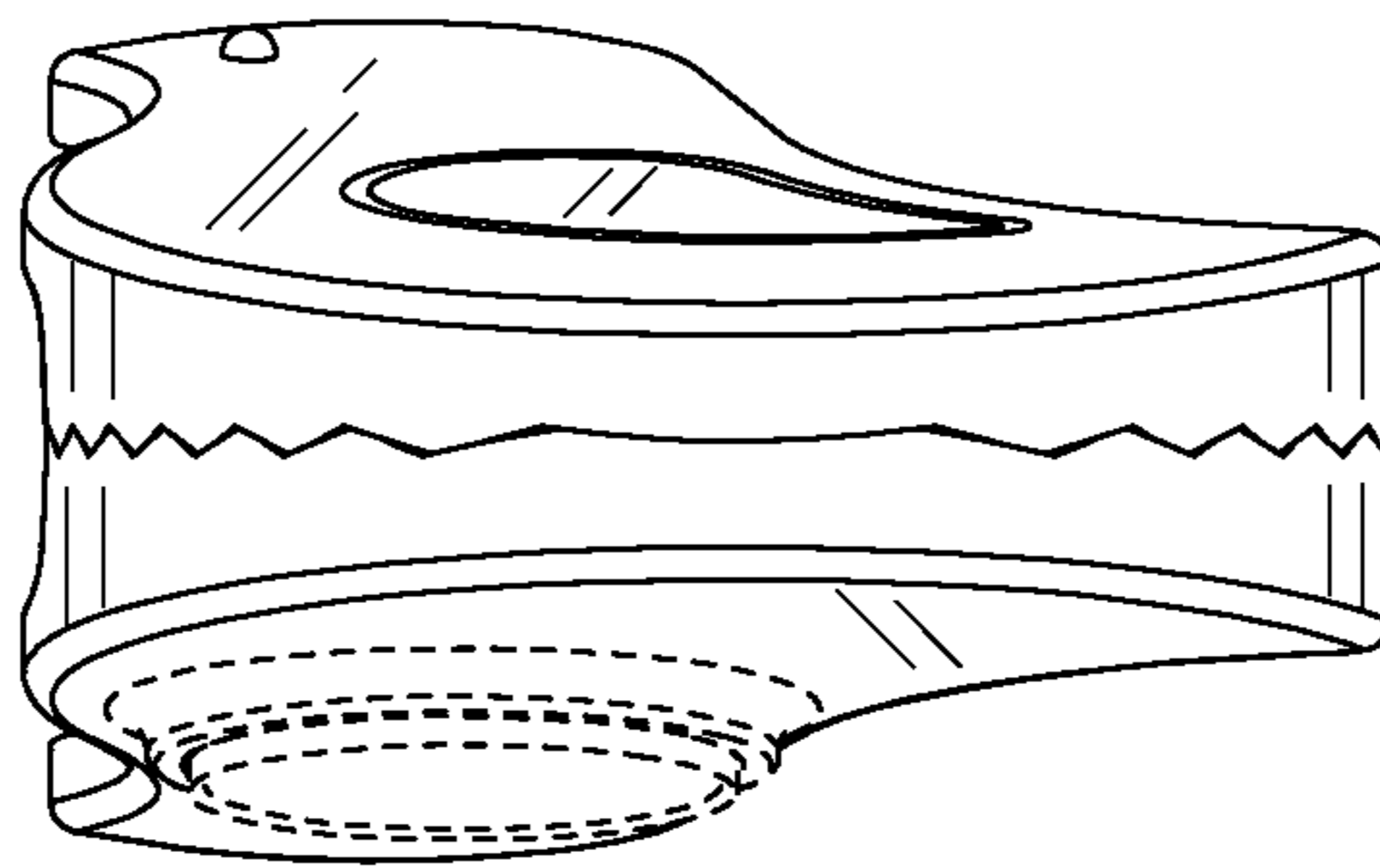

FIG. 6

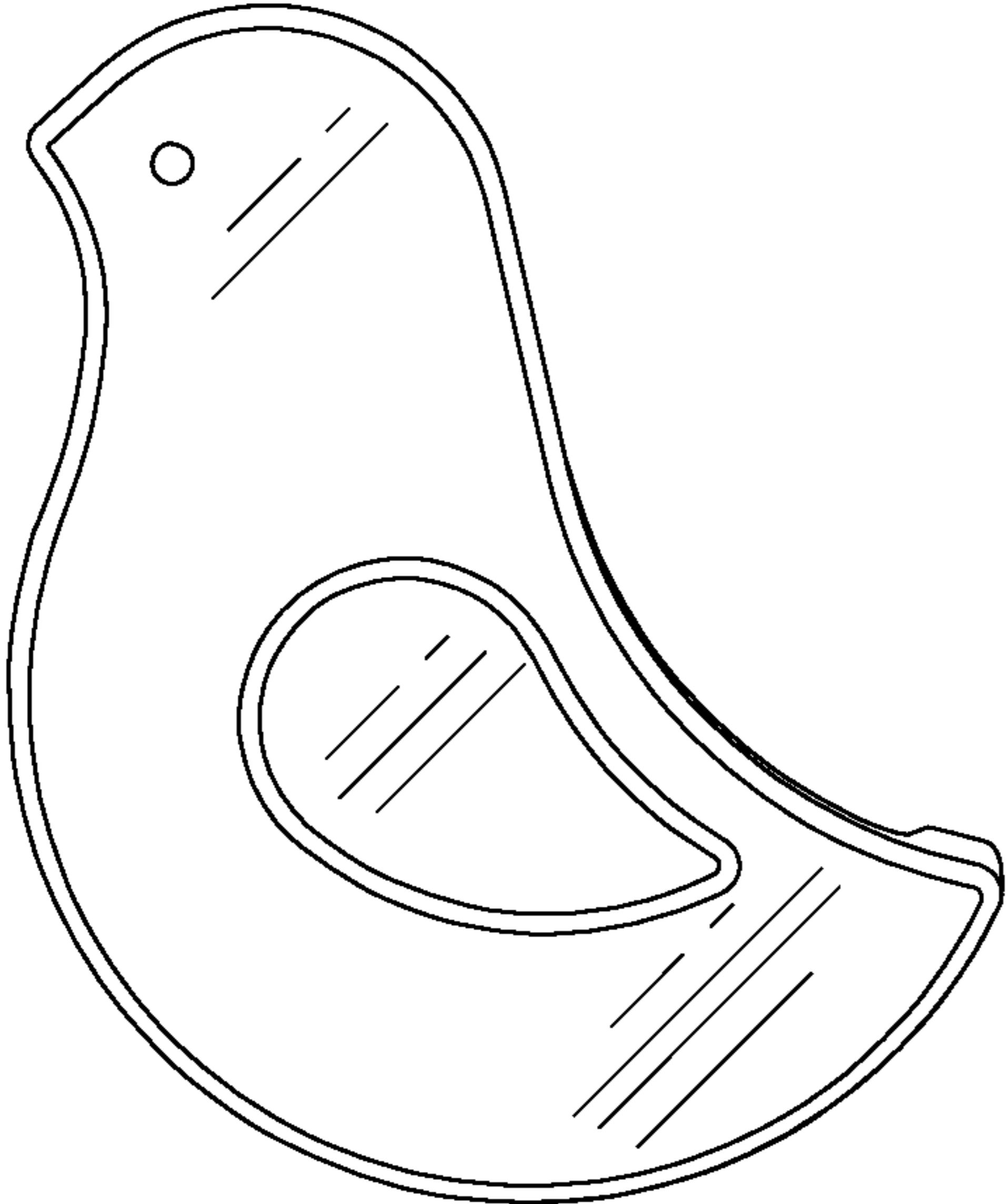

FIG. 3

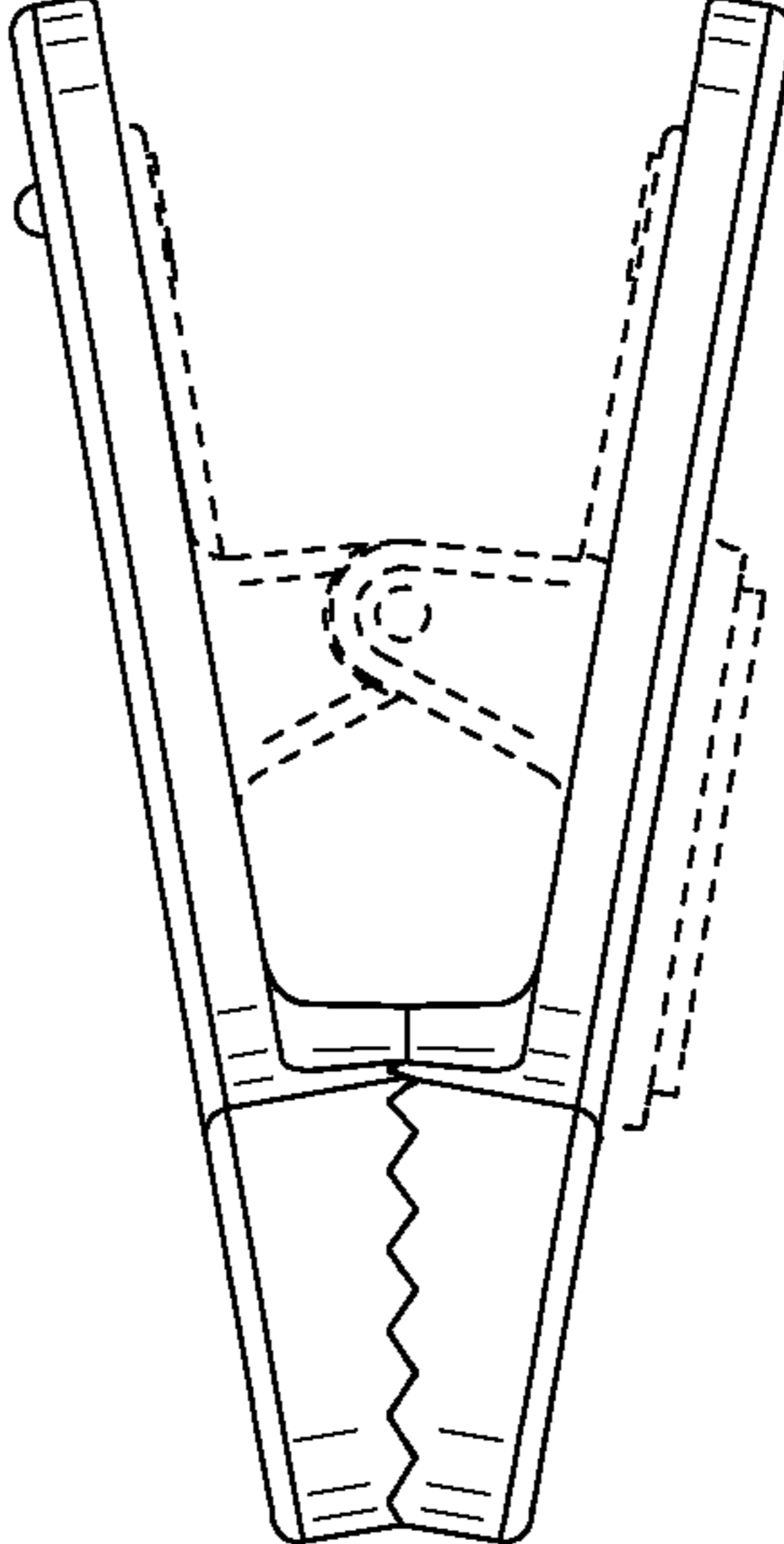

FIG. 4

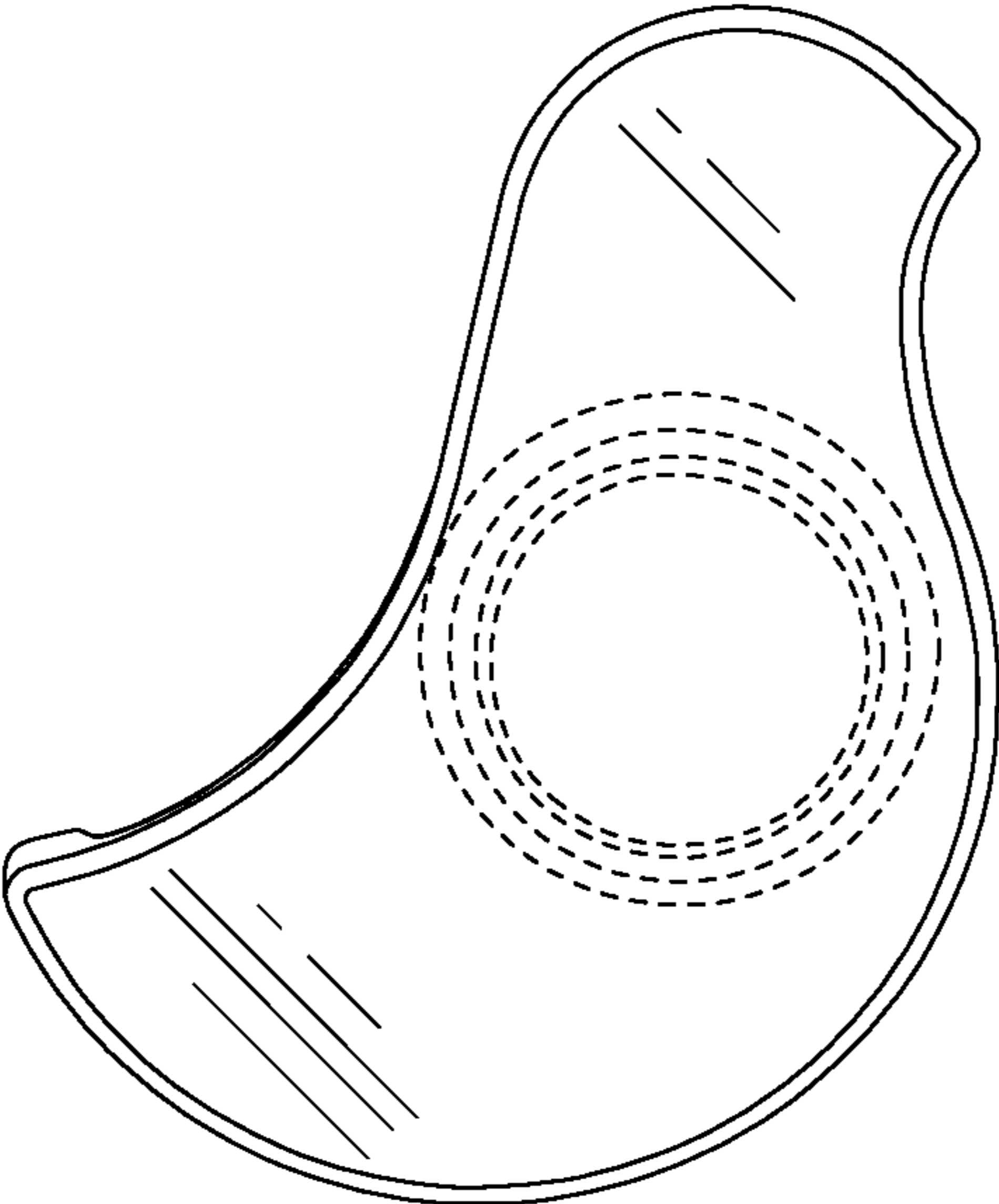

FIG. 5