

US00D697396S

(12) **United States Design Patent**
Goodman et al.

(10) **Patent No.:** **US D697,396 S**
(45) **Date of Patent:** **** Jan. 14, 2014**

(54) **MAGNET CLIP**

(75) Inventors: **Sheldon H. Goodman**, Solon, OH (US);
Phaysouk Xayoiphonh, Akron, OH
(US); **Grace Lee**, Mayfield, OH (US)

(73) Assignee: **Spectrum Diversified Designs, Inc.**,
Streetsboro, NC (US)

(**) Term: **14 Years**

(21) Appl. No.: **29/417,543**

(22) Filed: **Apr. 5, 2012**

(51) **LOC (10) Cl.** **08-08**

(52) **U.S. Cl.**
USPC **D8/395**

(58) **Field of Classification Search**
USPC D14/218, 455; D13/168; D21/566;
D10/104, 106; 345/169; 348/14.05,
348/114, 211.99, 734; 340/825.24; 341/22;
455/92, 95, 128, 151.1-151.4, 352,
455/355, FOR. 121; 700/65

See application file for complete search history.

(56) **References Cited**

U.S. PATENT DOCUMENTS

D19,504 S 12/1889 Cox et al.
D140,240 S 2/1945 Martinelli
D246,356 S 11/1977 Fox

5,027,439 A 7/1991 Spector
D321,008 S 10/1991 Cheng
5,322,718 A 6/1994 Low
D387,381 S 12/1997 Littmann
D409,881 S 5/1999 Lai
D411,085 S 6/1999 Biber
D497,637 S 10/2004 Cetera
D550,551 S 9/2007 Howard
D608,630 S 1/2010 Goodman et al.

Primary Examiner — John Windmuller

(74) *Attorney, Agent, or Firm* — Pearne & Gordon LLP

(57) **CLAIM**

The ornamental design for a magnet clip, as shown and described.

DESCRIPTION

FIG. 1 is a perspective view of a magnet clip showing our new design;
FIG. 2 is a top plan view thereof;
FIG. 3 is a front elevational view thereof;
FIG. 4 is a side elevational view thereof;
FIG. 5 is a rear elevational view thereof; and,
FIG. 6 is a bottom plan view thereof.
The dotted line showing in the drawings, illustrates environmental matter and forms no part of the claimed design.

1 Claim, 3 Drawing Sheets

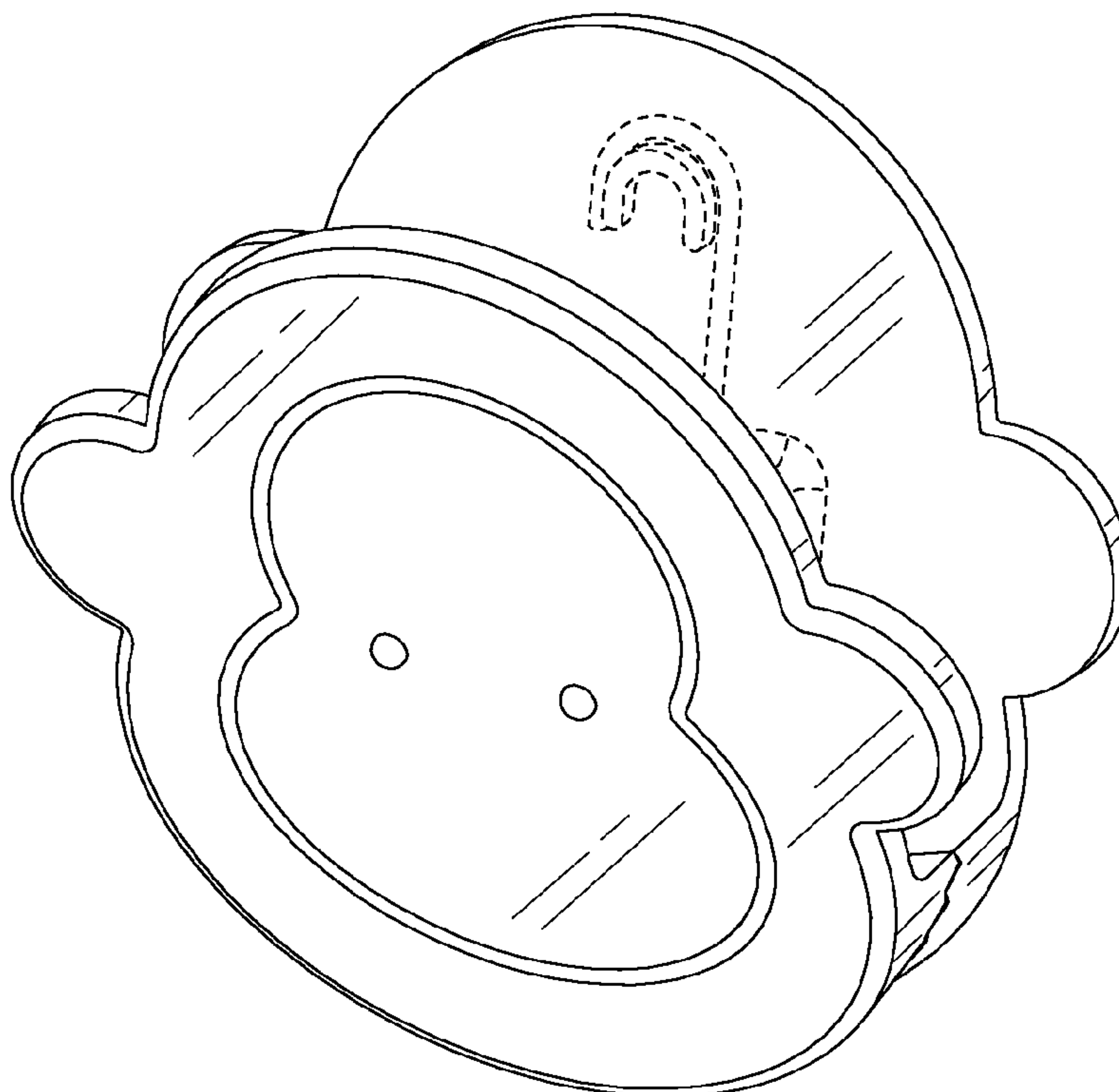

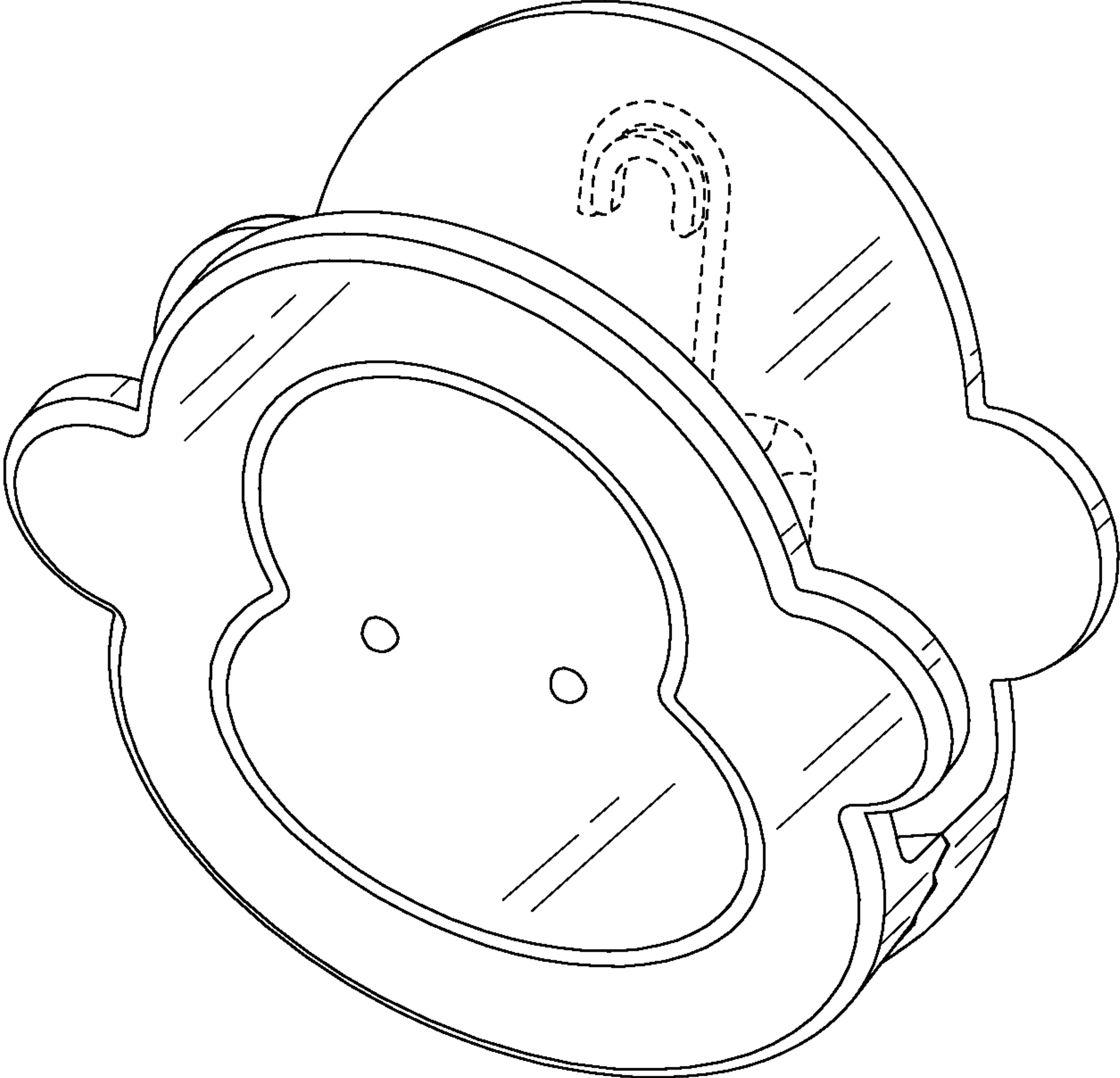

FIG. 1

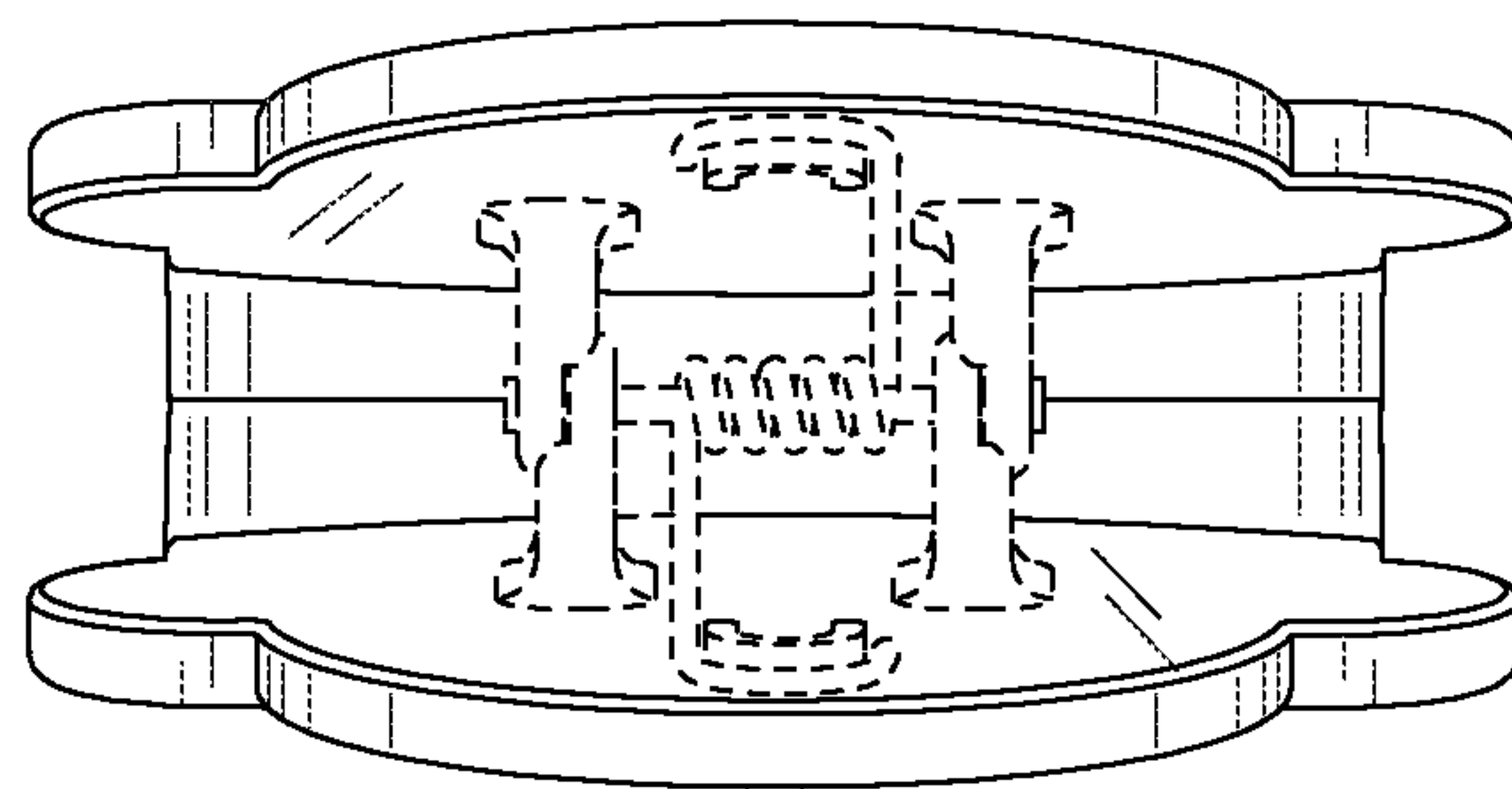

FIG. 2

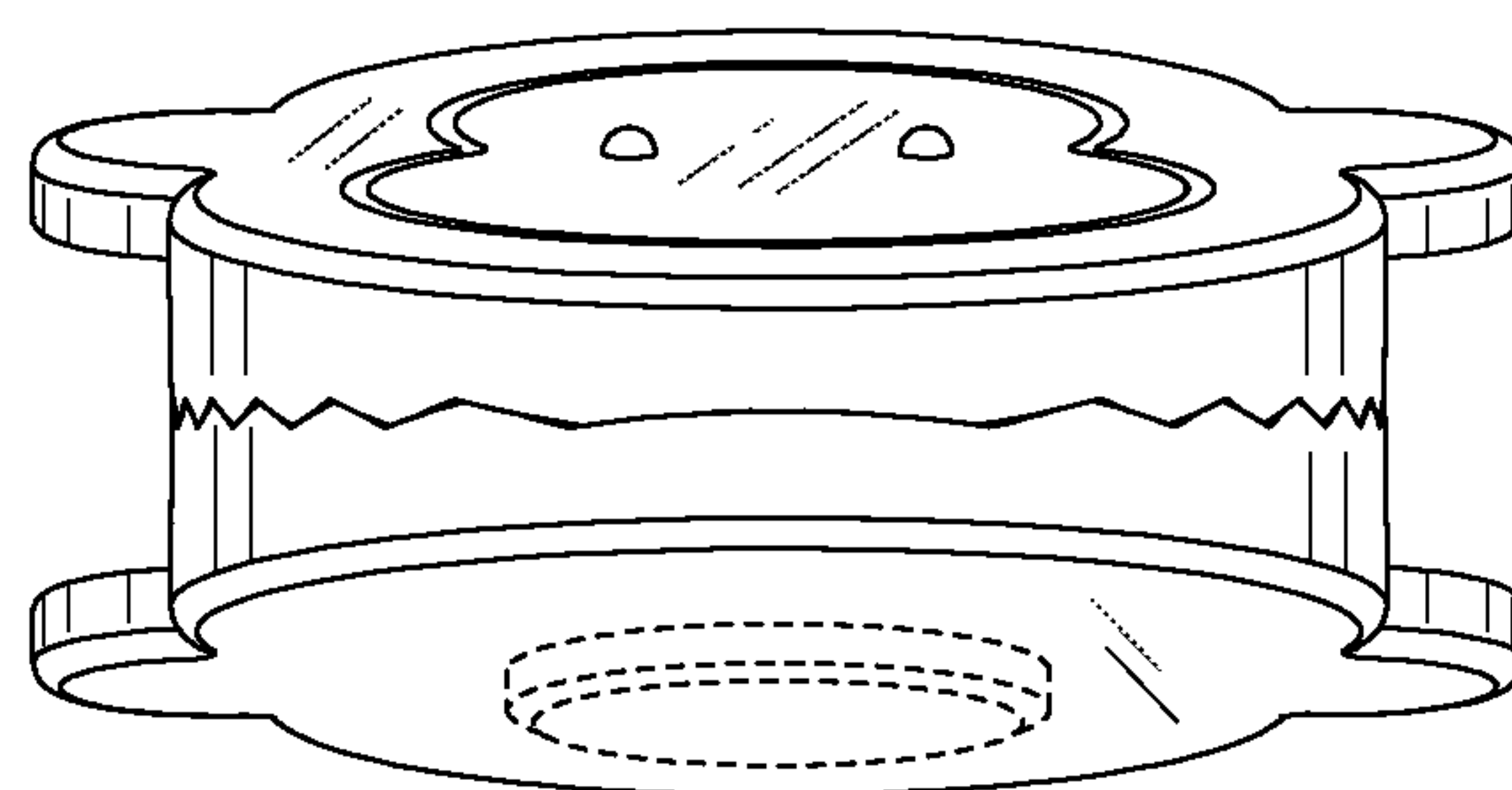

FIG. 6

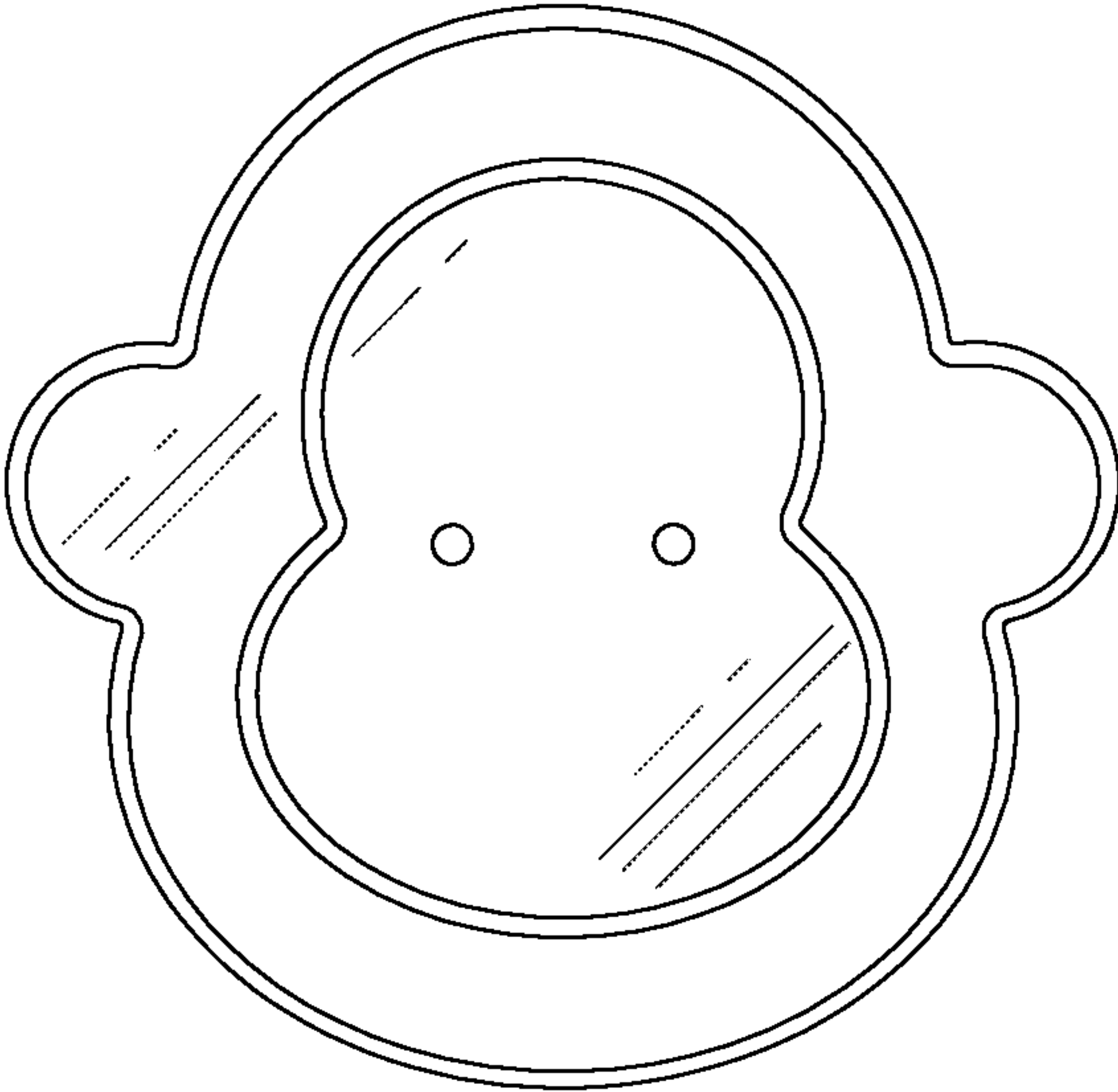

FIG. 3

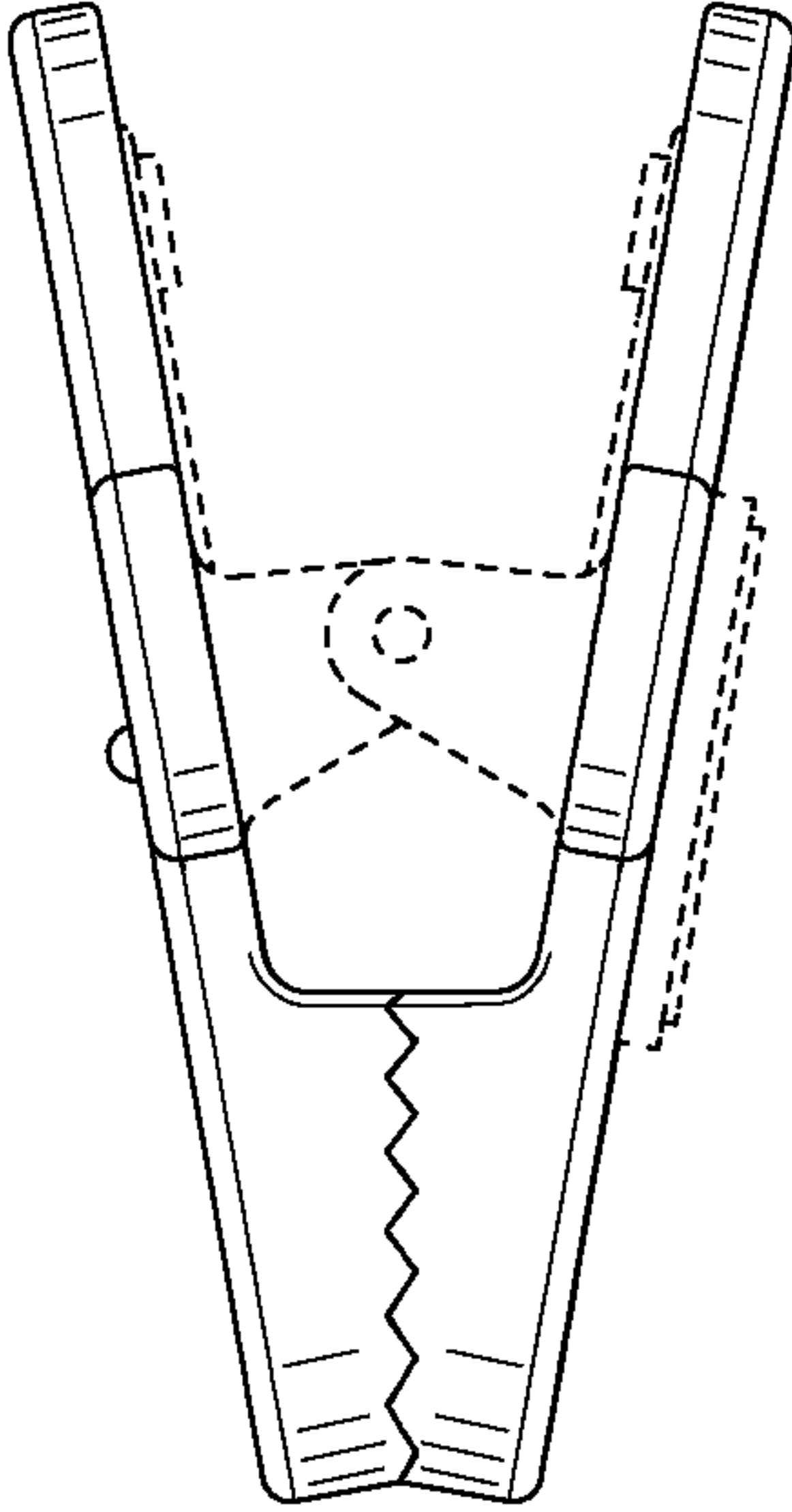

FIG. 4

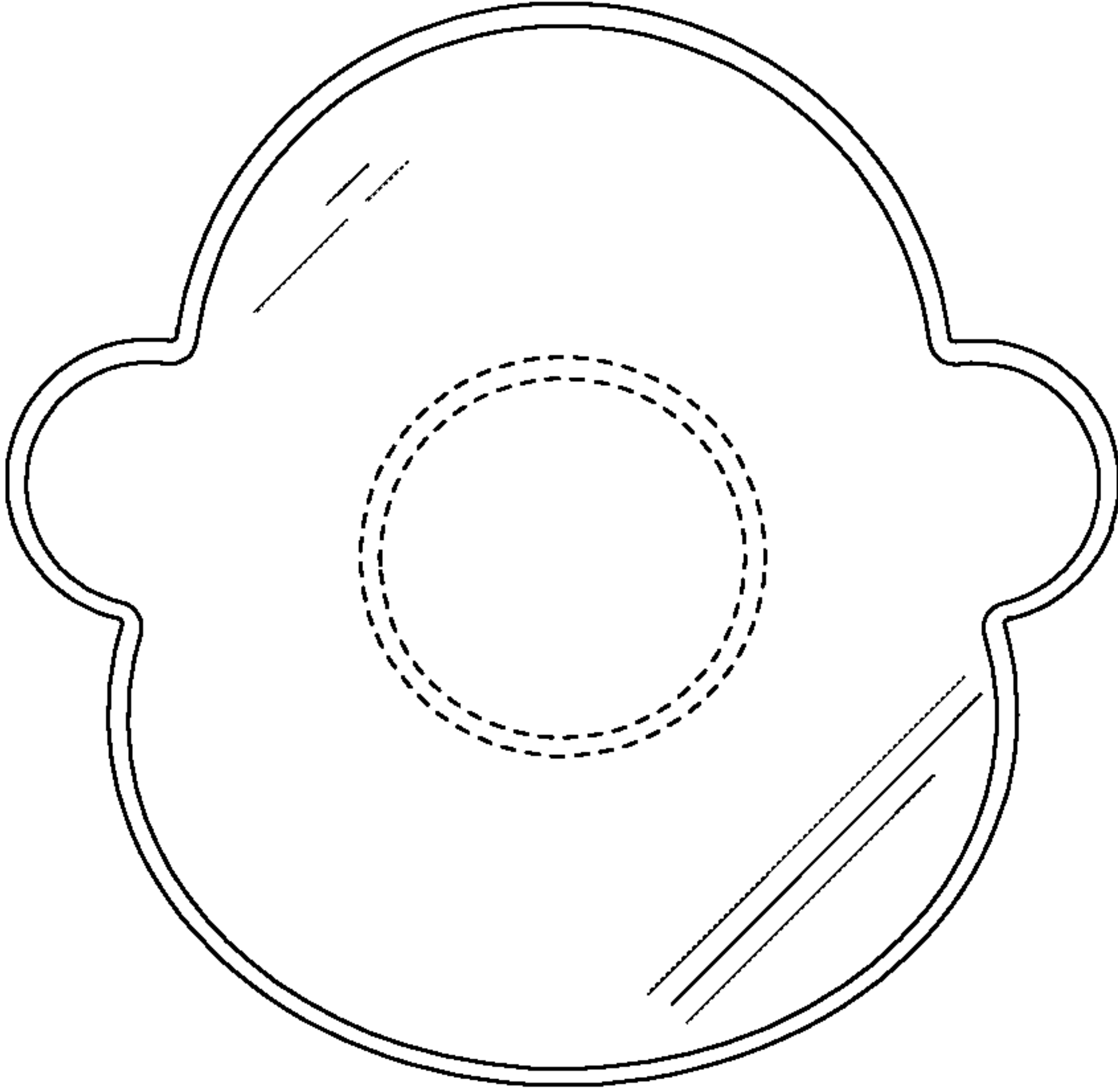

FIG. 5