

US00D697283S

(12) **United States Design Patent**
Tucker

(10) **Patent No.:** **US D697,283 S**
(45) **Date of Patent:** **** Jan. 7, 2014**

(54) **RIBBED FRAME**
(75) Inventor: **William C. Tucker**, Duncan (CA)
(73) Assignee: **Adaptive Vacuum Systems Ltd.**,
Duncan, BC (CA)

5,533,643 A * 7/1996 Kruzick 220/812
5,819,974 A * 10/1998 Caldwell 220/326
6,382,451 B1 * 5/2002 Di Filippo et al. 220/324
D547,918 S * 7/2007 Denbeste D34/11
D569,069 S * 5/2008 Ireland D34/11
D583,121 S * 12/2008 Self D34/11
8,210,383 B1 * 7/2012 Devita 220/315

(**) Term: **14 Years**
(21) Appl. No.: **29/417,082**
(22) Filed: **Mar. 29, 2012**

* cited by examiner
Primary Examiner — Cynthia Ramirez
(74) *Attorney, Agent, or Firm* — Schwabe, Williamson &
Wyatt

(30) **Foreign Application Priority Data**
Sep. 29, 2011 (CA) 142564
(51) **LOC (10) CL.** **09-09**
(52) **U.S. Cl.**
USPC **D34/10**
(58) **Field of Classification Search**
USPC D34/1, 7, 10, 11; 220/200, 908, 908.1,
220/910, 315, 326, 324
See application file for complete search history.

(57) **CLAIM**
The ornamental design for a ribbed frame, as shown and
described.

(56) **References Cited**
U.S. PATENT DOCUMENTS
4,502,610 A * 3/1985 Todd 220/315
D326,943 S * 6/1992 Taylor D34/11

DESCRIPTION
FIG. 1 is a perspective view of a ribbed frame;
FIG. 2 is top view of the ribbed frame illustrated in FIG. 1;
FIG. 3 is a right side view of the ribbed frame illustrated in
FIG. 1;
FIG. 4 is a left side view of the ribbed frame illustrated in FIG.
1;
FIG. 5 is a bottom view of the ribbed frame illustrated in FIG.
1; and,
FIG. 6 is a front view of the ribbed frame illustrated in FIG. 1.

1 Claim, 6 Drawing Sheets

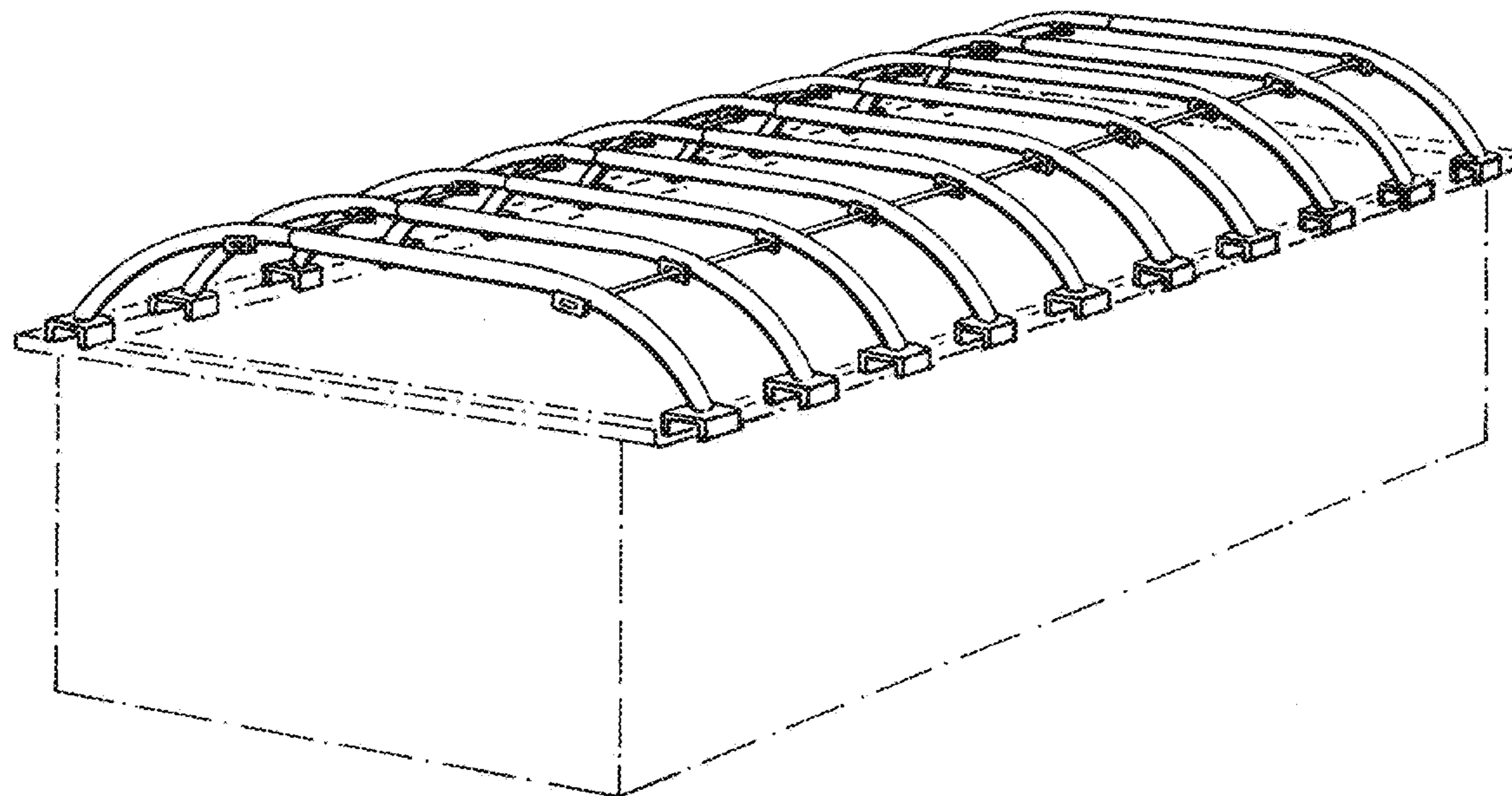

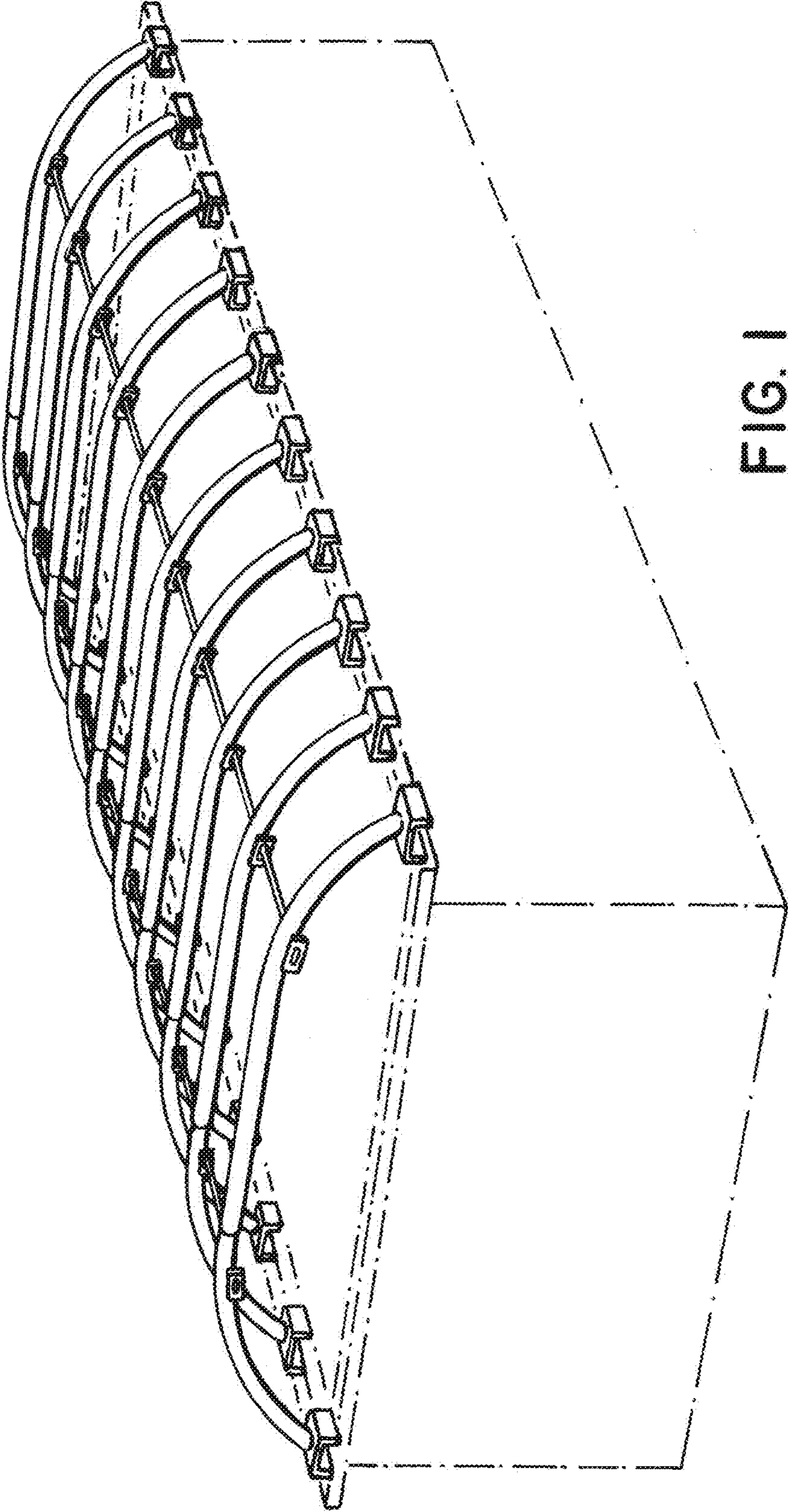

FIG. 1

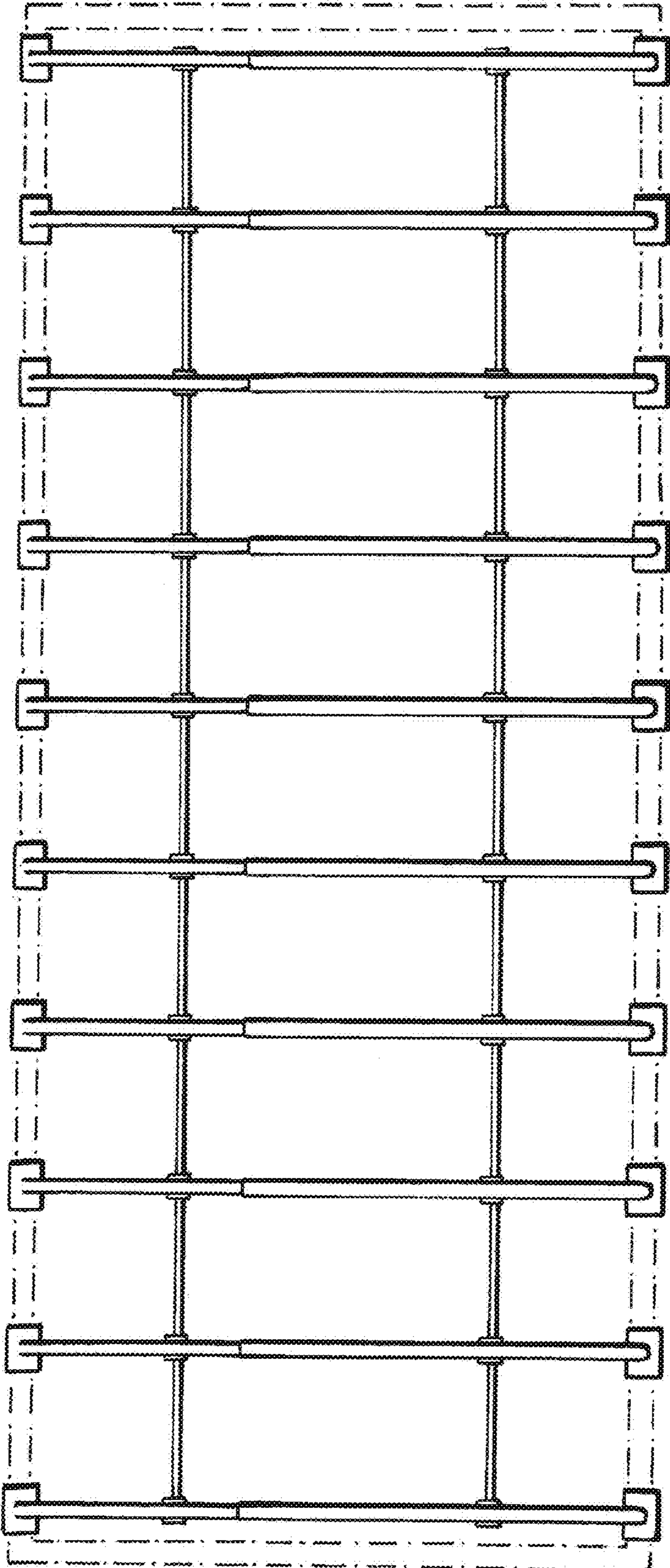

FIG. 2

Attorney Docket No.: Adaptive D001
First Named Inventor: Tucker
Title: RIBBED FRAME

Page 3 of 6
Application No.: Not Yet Assigned
Date of Transmission: March 29, 2012

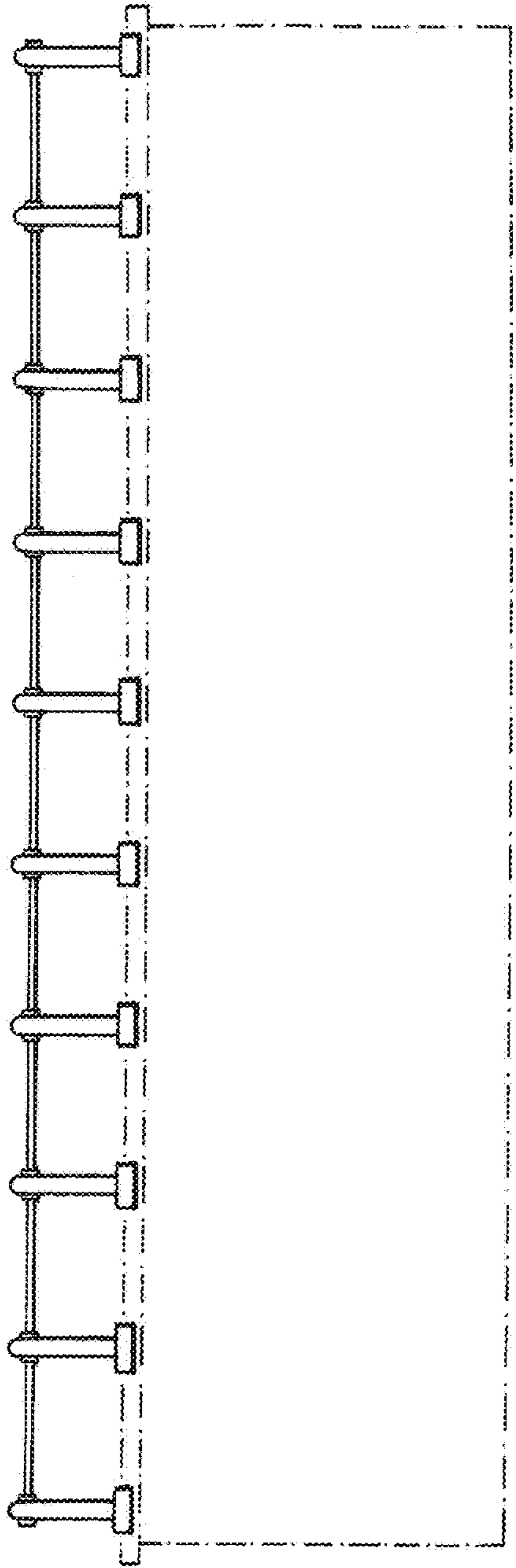

FIG. 3

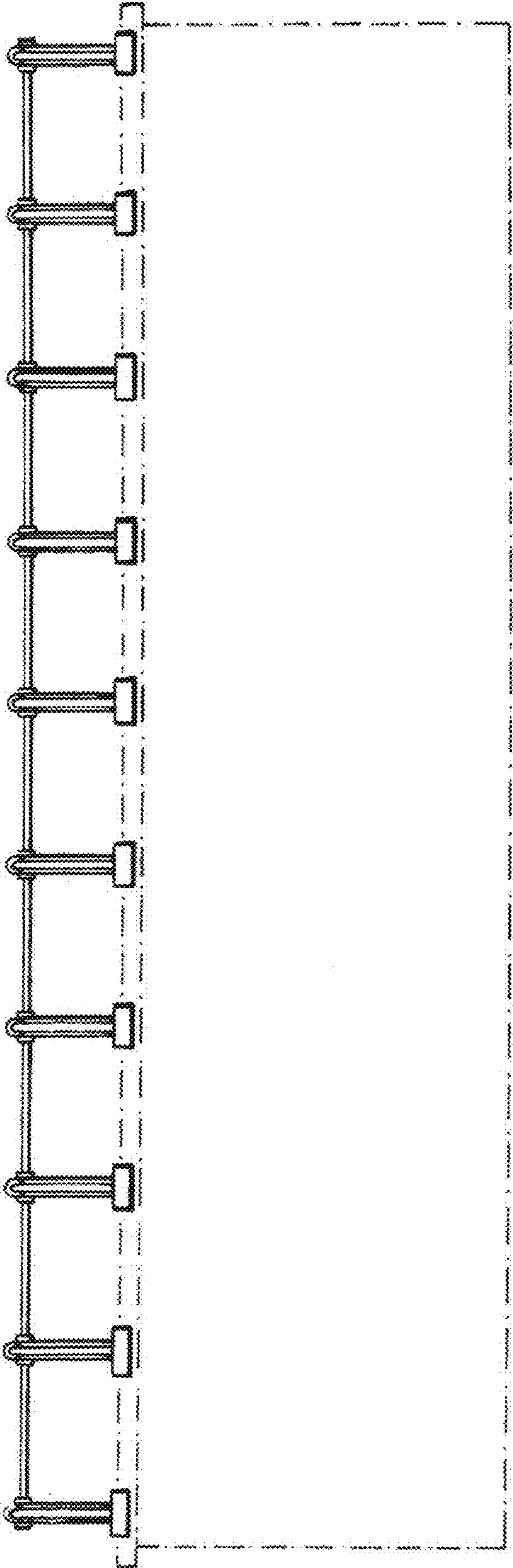

FIG. 4

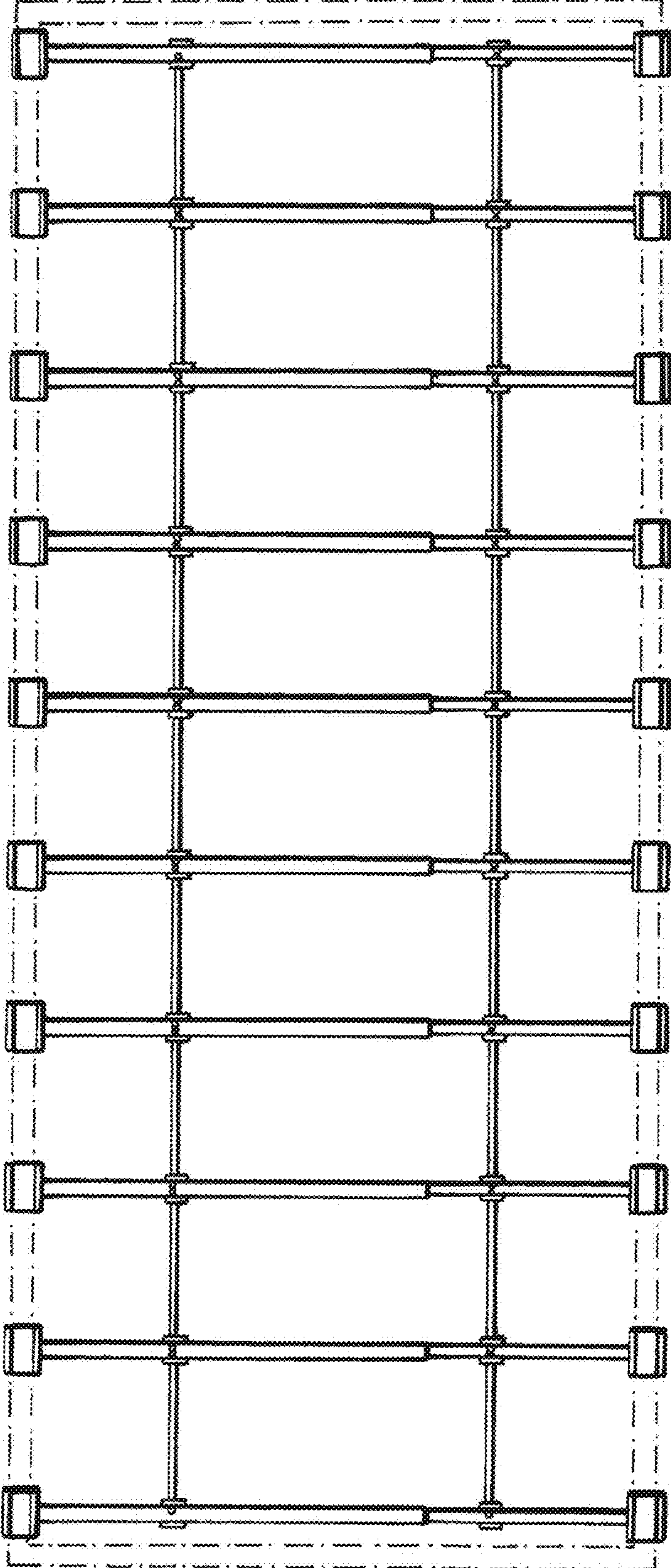

FIG. 5

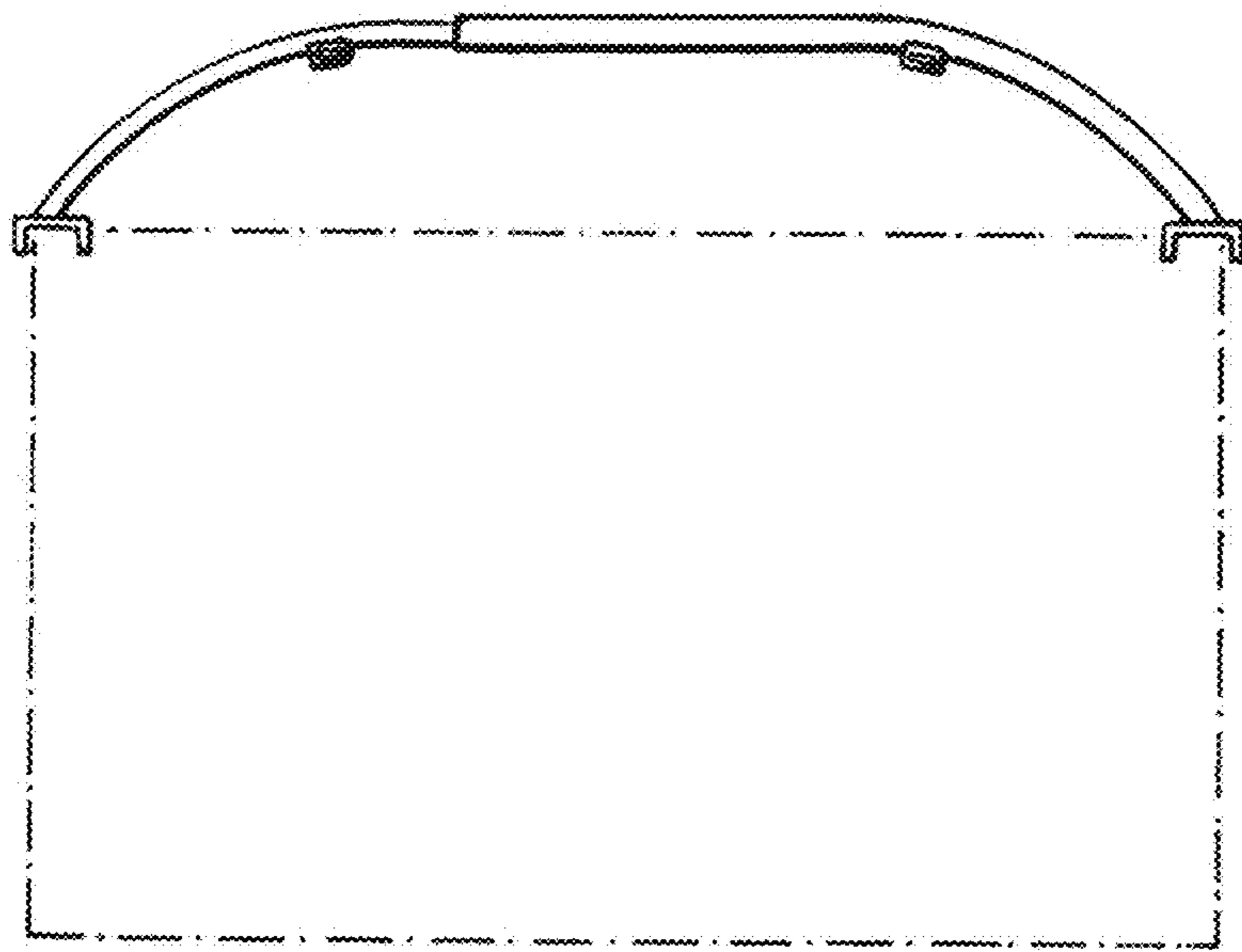

FIG. 6