



US00D697222S

(12) **United States Design Patent**
Imboden et al.

(10) **Patent No.:** **US D697,222 S**
(45) **Date of Patent:** **** Jan. 7, 2014**

(54) **PERSONAL MASSAGER**

(71) Applicant: **Jimmy Jane, Inc.**, San Francisco, CA
(US)

(72) Inventors: **Ethan F. Imboden**, San Francisco, CA
(US); **Jeff Wyatt**, Bozeman, MT (US)

(73) Assignee: **Jimmy Jane, Inc.**, San Francisco, CA
(US)

(**) Term: **14 Years**

(21) Appl. No.: **29/433,660**

(22) Filed: **Oct. 2, 2012**

(51) **LOC (10) Cl.** **28-03**

(52) **U.S. Cl.**
USPC **D24/215**

(58) **Field of Classification Search**
USPC D24/200, 211, 212, 213, 214, 215;
601/114, 120, 121, 124, 125, 130, 131,
601/134, 135, 136, 137
See application file for complete search history.

(56) **References Cited**

U.S. PATENT DOCUMENTS

3,461,859	A *	8/1969	Fortnam	601/74
4,461,285	A *	7/1984	Courtin	601/137
D345,801	S *	4/1994	Bosch	D24/200
D378,135	S *	2/1997	Sirois et al.	D24/215
5,601,529	A *	2/1997	Wollman	601/74
D415,569	S *	10/1999	Wyrwa et al.	D24/211
5,986,643	A *	11/1999	Harvill et al.	345/156
6,203,509	B1 *	3/2001	Duboff	601/70
D459,478	S *	6/2002	Perricone	D24/200
6,748,604	B2 *	6/2004	Duboff et al.	2/160

6,966,883	B2 *	11/2005	Pidcock	601/123
D514,226	S *	1/2006	Nan	D24/215
6,991,598	B2 *	1/2006	Klein	600/38
D519,641	S *	4/2006	Lansohn	D24/209
D560,810	S *	1/2008	Hennessy	D24/215
D597,211	S *	7/2009	Ewing et al.	D24/187
D626,656	S *	11/2010	Jarry	D24/215
D636,887	S *	4/2011	Nan	D24/215

(Continued)

Primary Examiner — Sandra Snapp

(57) **CLAIM**

The ornamental design for a personal massager, as shown described.

DESCRIPTION

FIG. 1 is a front perspective view of a personal massager having at least one massaging sleeve and a dock element; FIG. 2 is a front view of the personal massager of FIG. 1; FIG. 3 is a rear view of the personal massager of FIG. 1; FIG. 4 is a left side view of the personal massager of FIG. 1; FIG. 5 is a right side view of the personal massager of FIG. 1; FIG. 6 is a top view of the personal massager of FIG. 1; FIG. 7 is a bottom view of the personal massager of FIG. 1; FIG. 8 is a front perspective view of the dock element removed for ease of illustration; FIG. 9 is a front view of the dock of FIG. 8; FIG. 10 is a rear view of the dock of FIG. 8; FIG. 11 is a left side view of the dock of FIG. 8; FIG. 12 is a right side view of the dock of FIG. 8; FIG. 13 is a top view of the dock of FIG. 8; and, FIG. 14 is a bottom view of the dock of FIG. 8. Elements shown in broken lines are for illustrative purposes only and form no part of our claimed design.

1 Claim, 8 Drawing Sheets

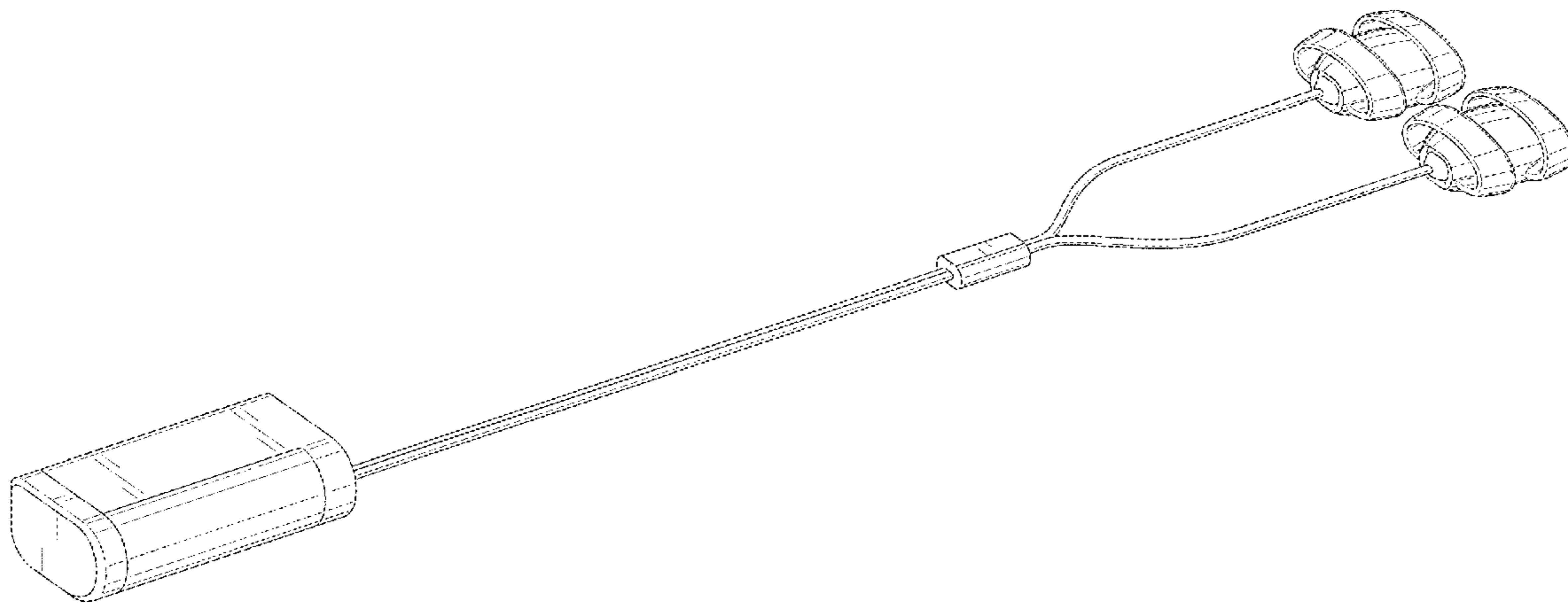

US D697,222 S

Page 2

(56)

References Cited

U.S. PATENT DOCUMENTS

D637,306 S * 5/2011 Feuerabend et al. D24/215
D649,258 S * 11/2011 Lev-Ran D24/215
D657,885 S * 4/2012 Imboden et al. D24/215

D664,665 S * 7/2012 Wahng et al. D24/214
D665,093 S * 8/2012 Sedic D24/215
D669,996 S * 10/2012 Chen D24/214
D674,108 S * 1/2013 York D24/215
2004/0267341 A1* 12/2004 Harrison 607/108

* cited by examiner

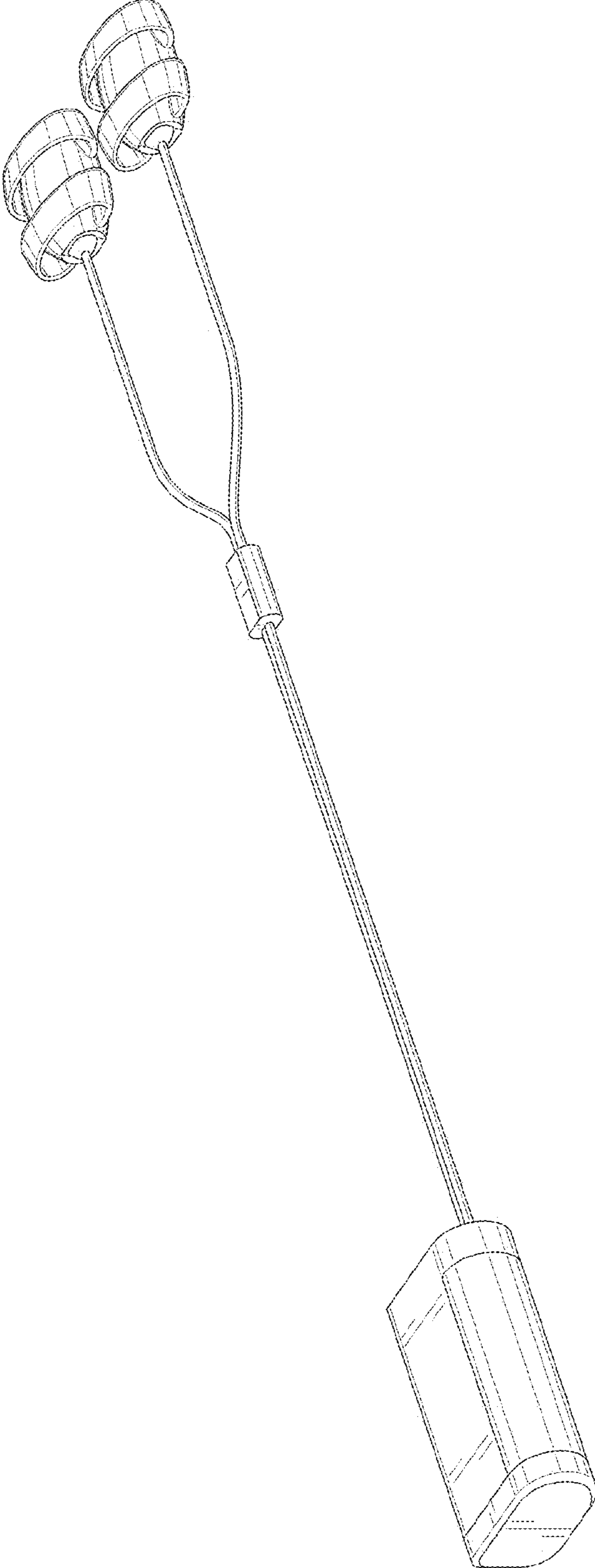

FIG. 1

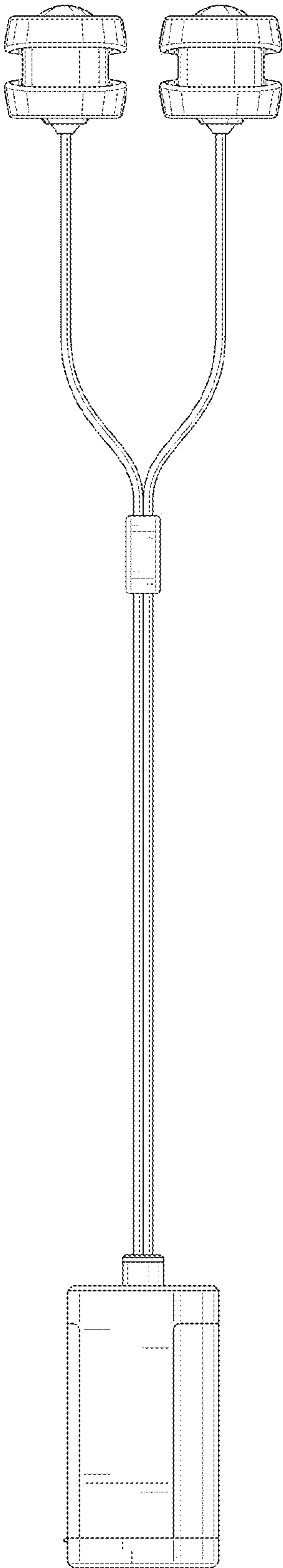

FIG. 2

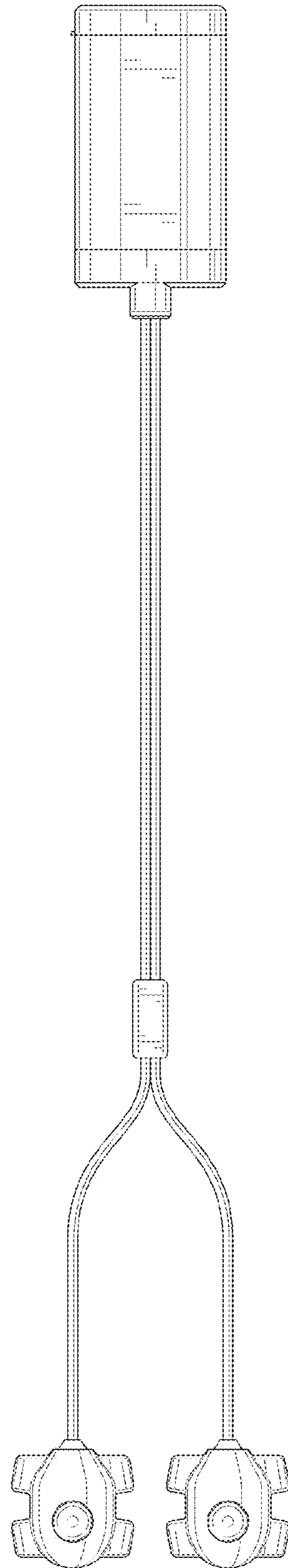

FIG. 3

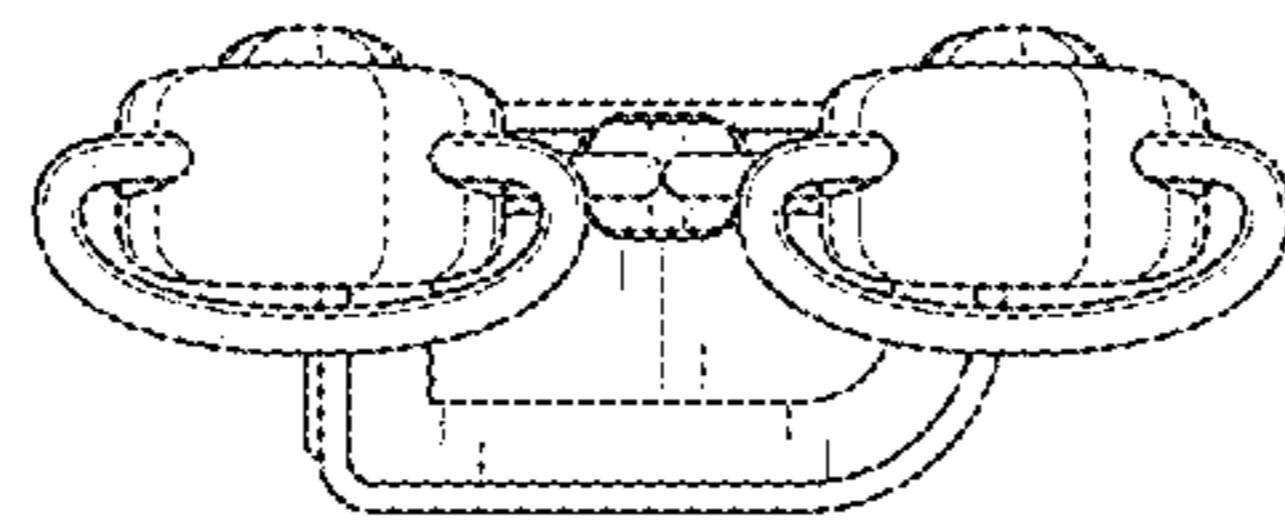

FIG. 5

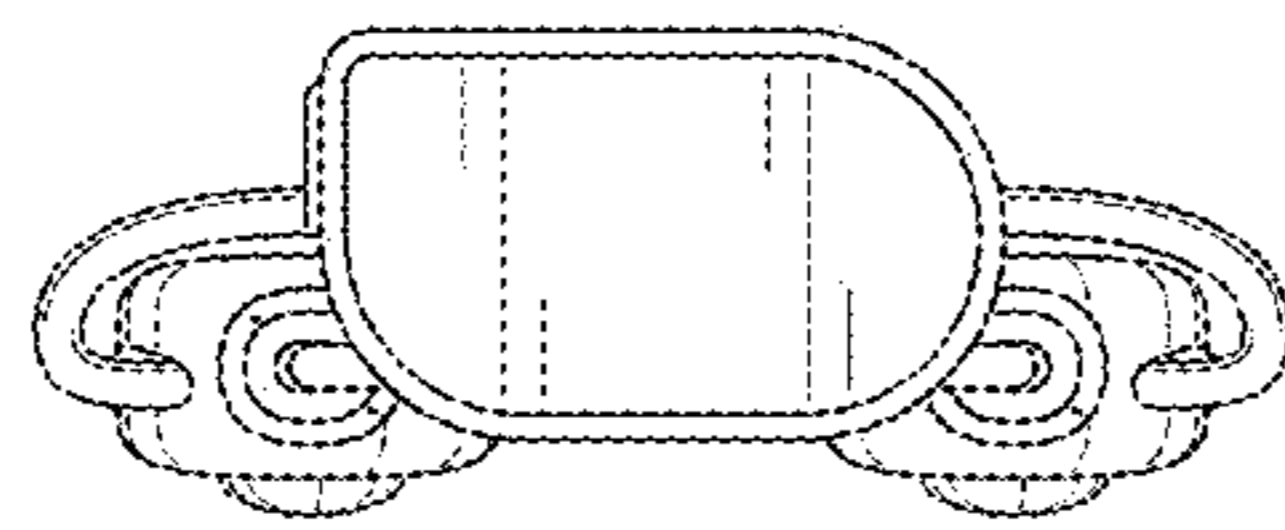

FIG. 4

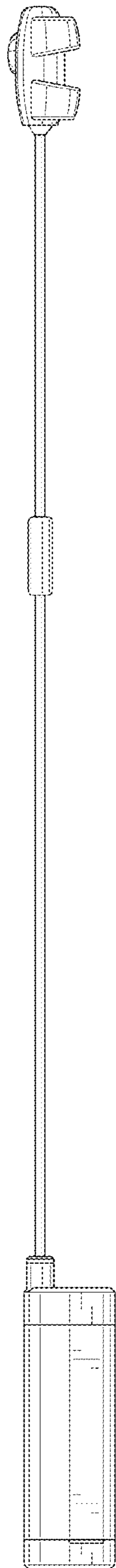

FIG. 6

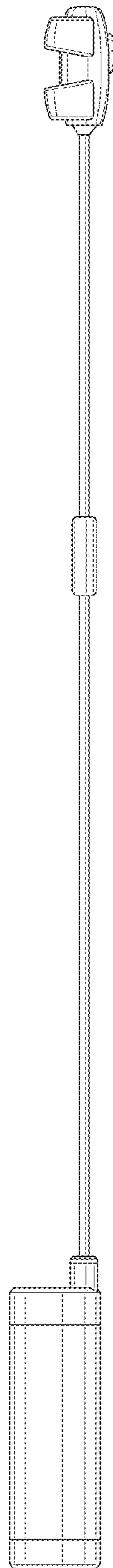

FIG. 7

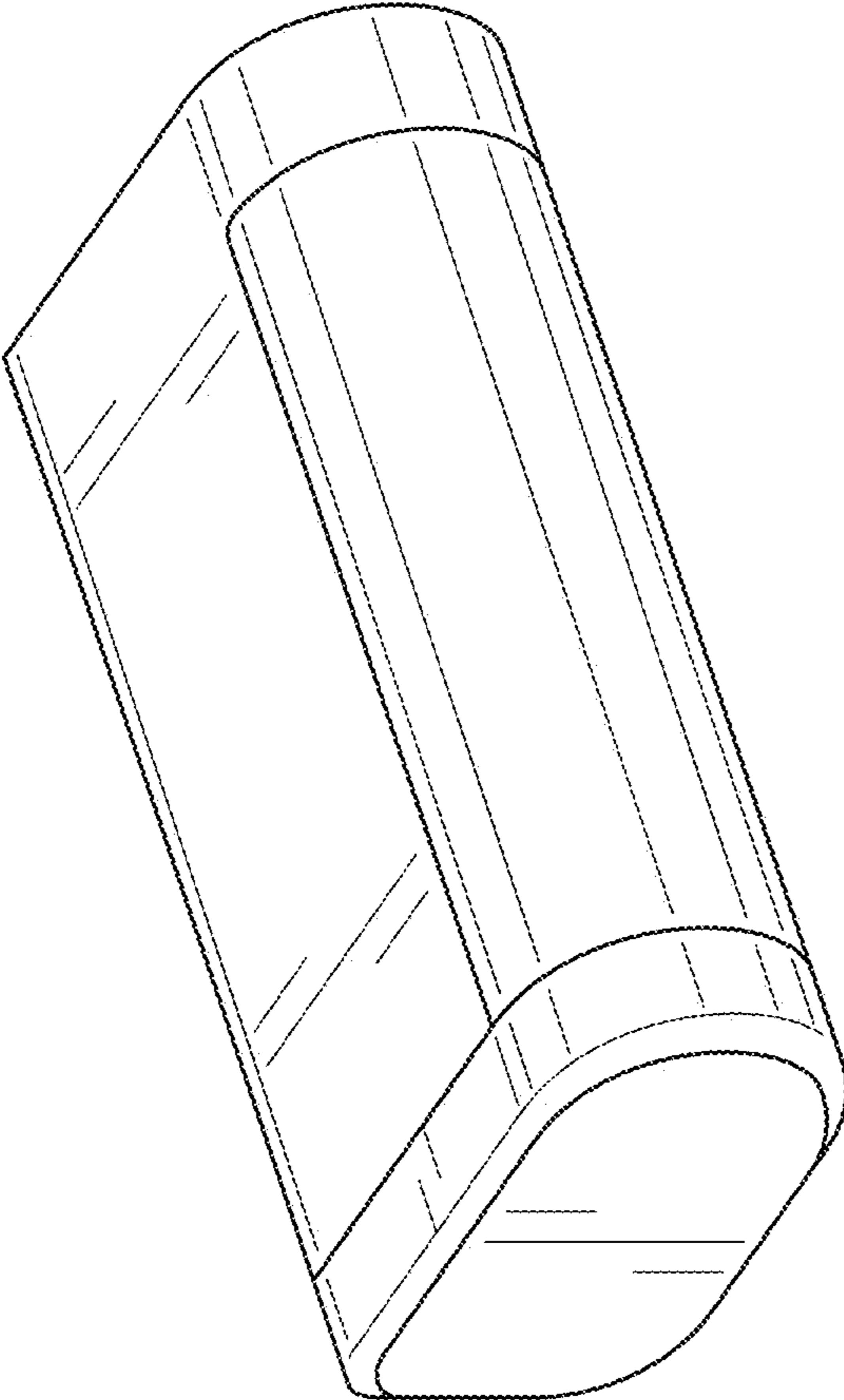

FIG. 8

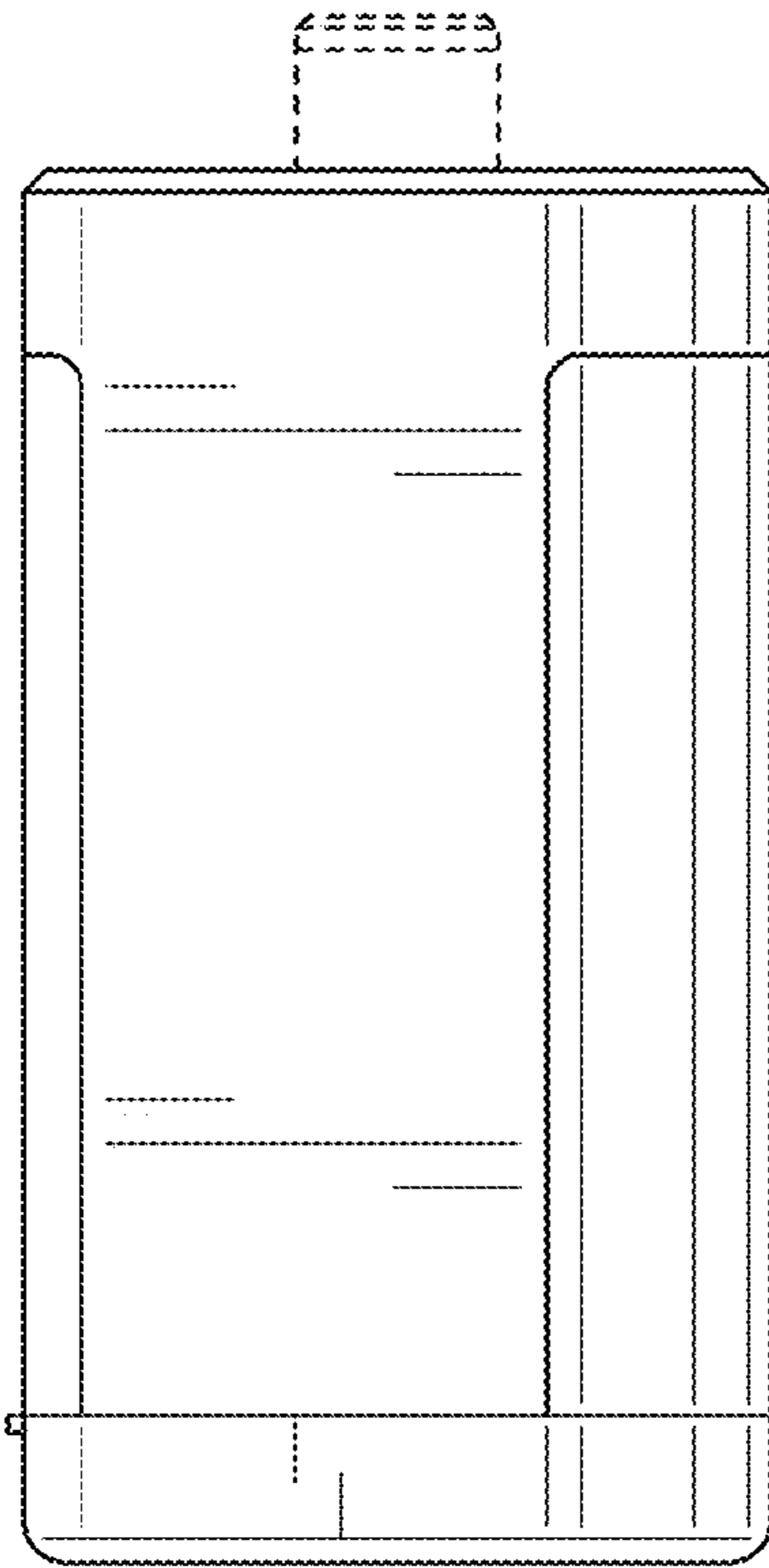

FIG. 9

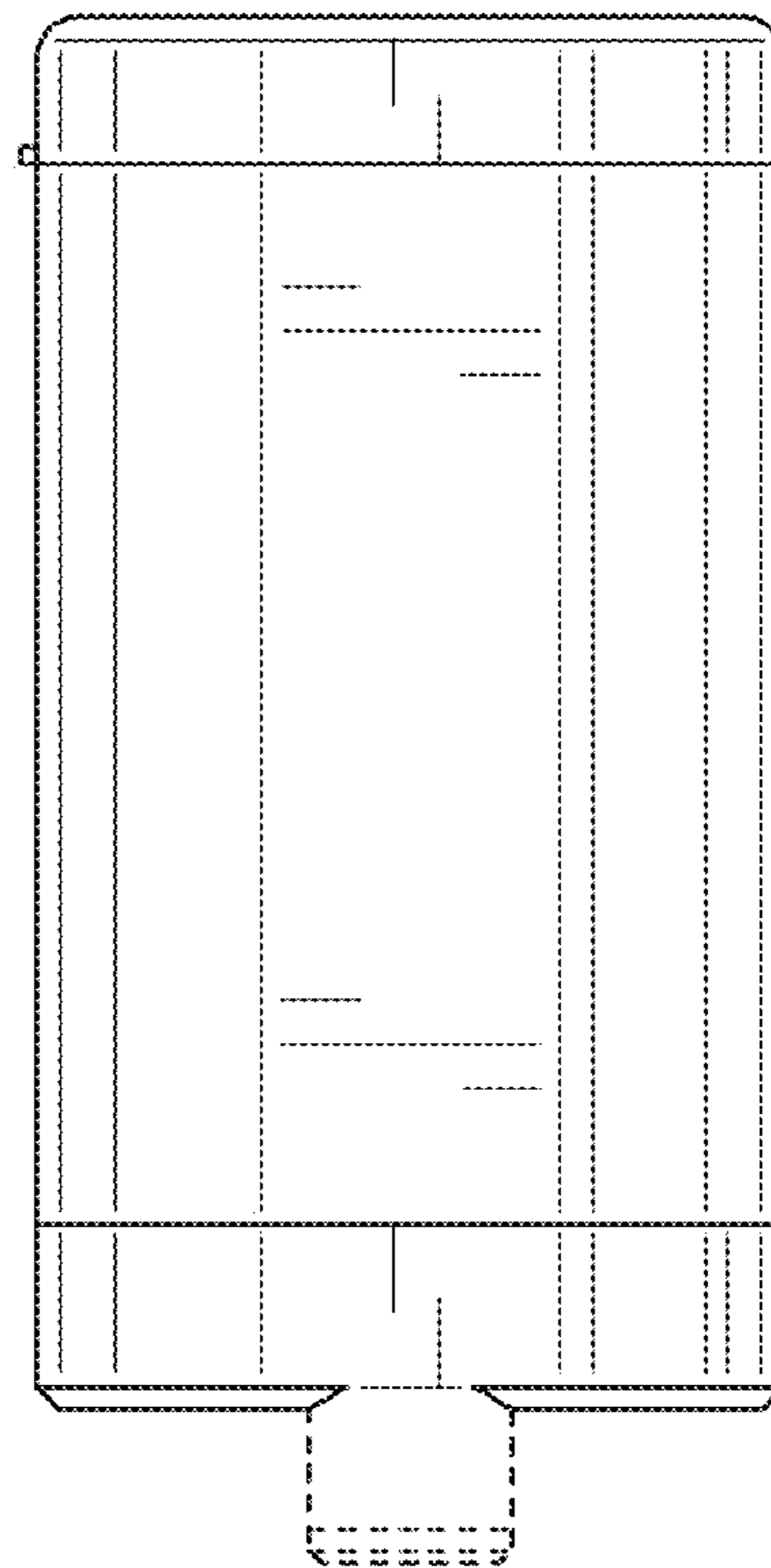

FIG. 10

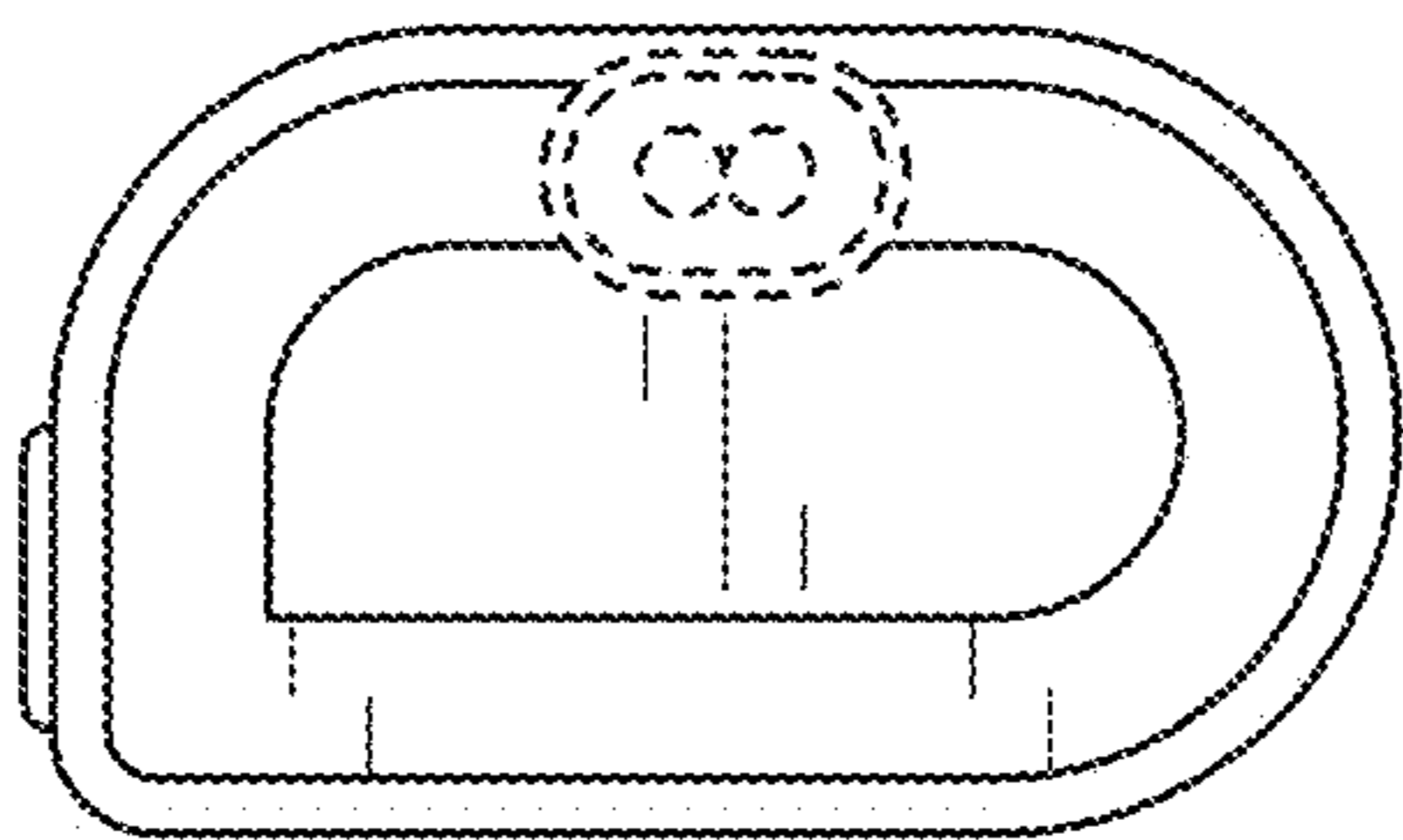

FIG. 12

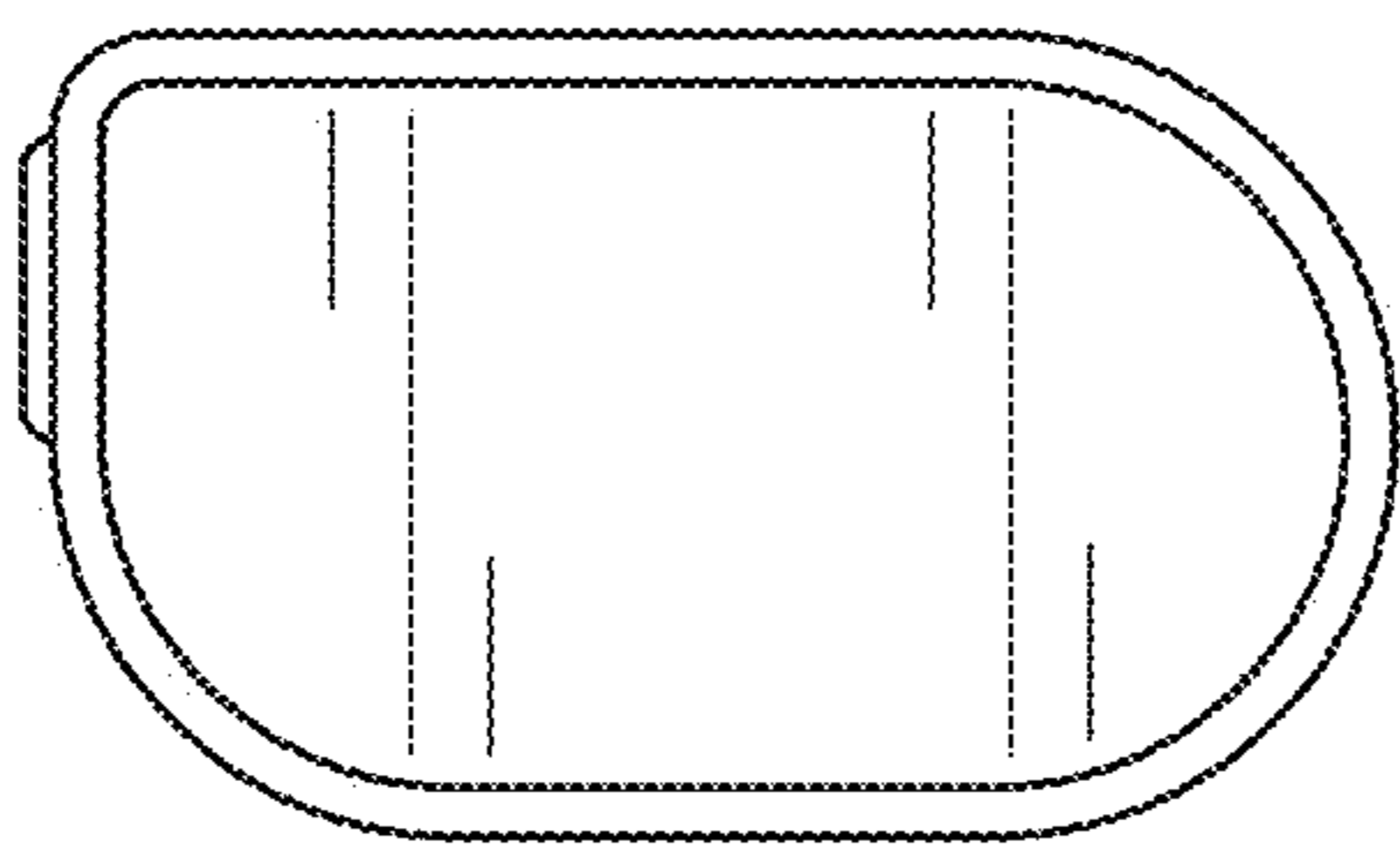

FIG. 11

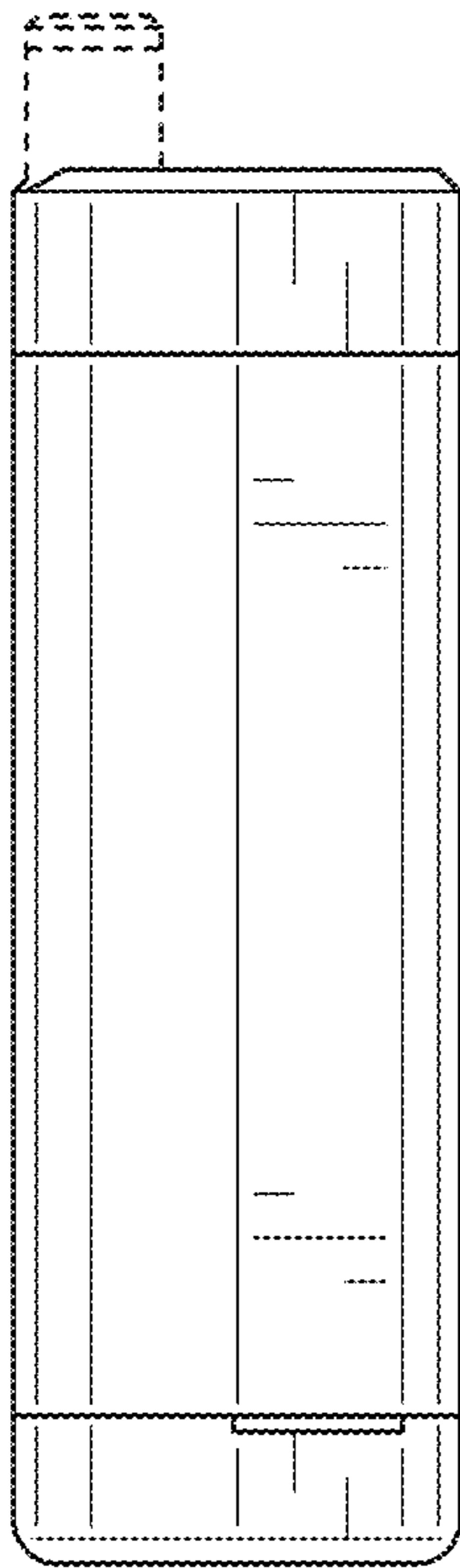

FIG. 13

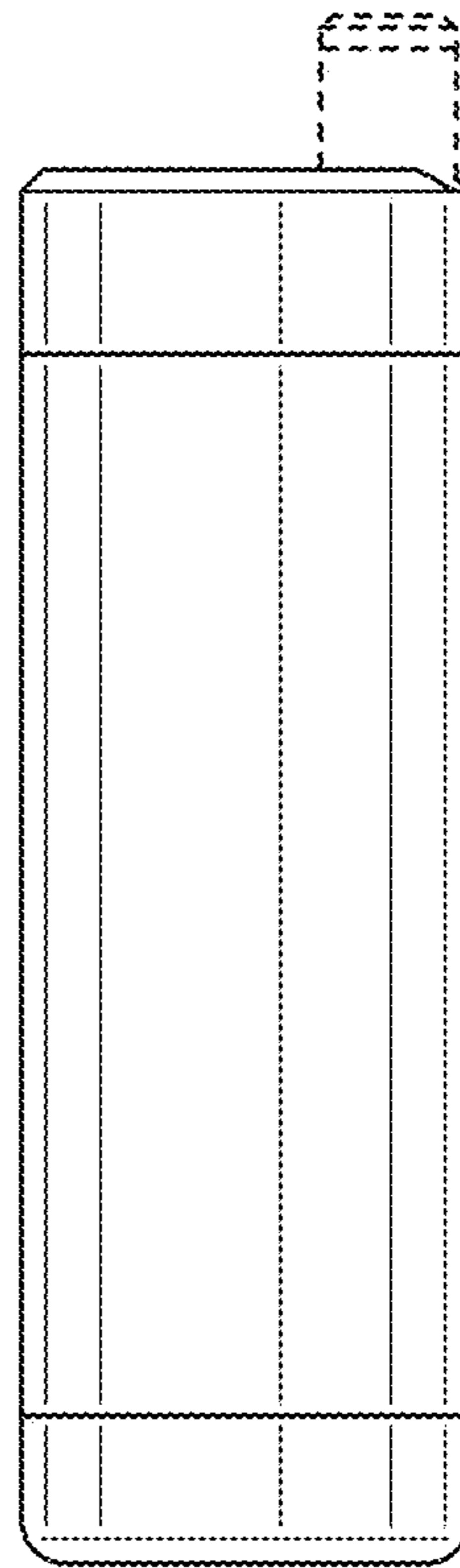

FIG. 14