



US00D697178S

(12) **United States Design Patent**
Georgeson et al.

(10) **Patent No.:** **US D697,178 S**
(45) **Date of Patent:** **** Jan. 7, 2014**

(54) **FAUCET**

(74) *Attorney, Agent, or Firm* — Foley & Lardner LLP

(71) Applicant: **Kohler Co.**, Kohler, WI (US)

(57) **CLAIM**

We claim the ornamental design for a faucet, as shown and described.

(72) Inventors: **Paul B. Georgeson**, Sheboygan, WI (US); **Rafael A. Rexach**, Sheboygan, WI (US)

(73) Assignee: **Kohler Co.**, Kohler, WI (US)

(**) Term: **14 Years**

(21) Appl. No.: **29/447,075**

(22) Filed: **Feb. 28, 2013**

(51) **LOC (10) Cl.** **23-01**

(52) **U.S. Cl.**
USPC **D23/255**

(58) **Field of Classification Search**
USPC D23/238, 241–243, 250, 252, 255, 257;
4/675–678; 137/801
See application file for complete search history.

(56) **References Cited**

U.S. PATENT DOCUMENTS

4,901,380	A *	2/1990	Smith	4/596
D310,557	S *	9/1990	Smith	D23/275
D495,788	S *	9/2004	Helmetsie et al.	D23/283
D576,262	S *	9/2008	Ishiyama et al.	D23/305
D628,683	S *	12/2010	Andrew et al.	D23/305
D629,089	S *	12/2010	Yoo et al.	D23/305

* cited by examiner

Primary Examiner — Robert Delehanty

DESCRIPTION

FIG. 1 is a perspective view of the claimed design;
 FIG. 2 is a front view of the claimed design shown in FIG. 1;
 FIG. 3 is a rear view of the claimed design shown in FIG. 1;
 FIG. 4 is a side view of the claimed design shown in FIG. 1;
 FIG. 5 is another side view of the claimed design shown in FIG. 1;
 FIG. 6 is a top view of the claimed design shown in FIG. 1;
 FIG. 7 is a bottom view of the claimed design shown in FIG. 1;
 FIG. 8 is a perspective view of another embodiment of the claimed design;
 FIG. 9 is a front view of the claimed design shown in FIG. 8;
 FIG. 10 is a rear view of the claimed design shown in FIG. 8;
 FIG. 11 is a side view of the claimed design shown in FIG. 8;
 FIG. 12 is another side view of the claimed design shown in FIG. 8;
 FIG. 13 is a top view of the claimed design shown in FIG. 8;
 and,
 FIG. 14 is a bottom view of the claimed design shown in FIG. 8.

The ornamental design which is claimed is shown in solid lines in the drawings: The broken lines in the drawings are for illustrative purposes only and form no part of the claimed design.

1 Claim, 14 Drawing Sheets

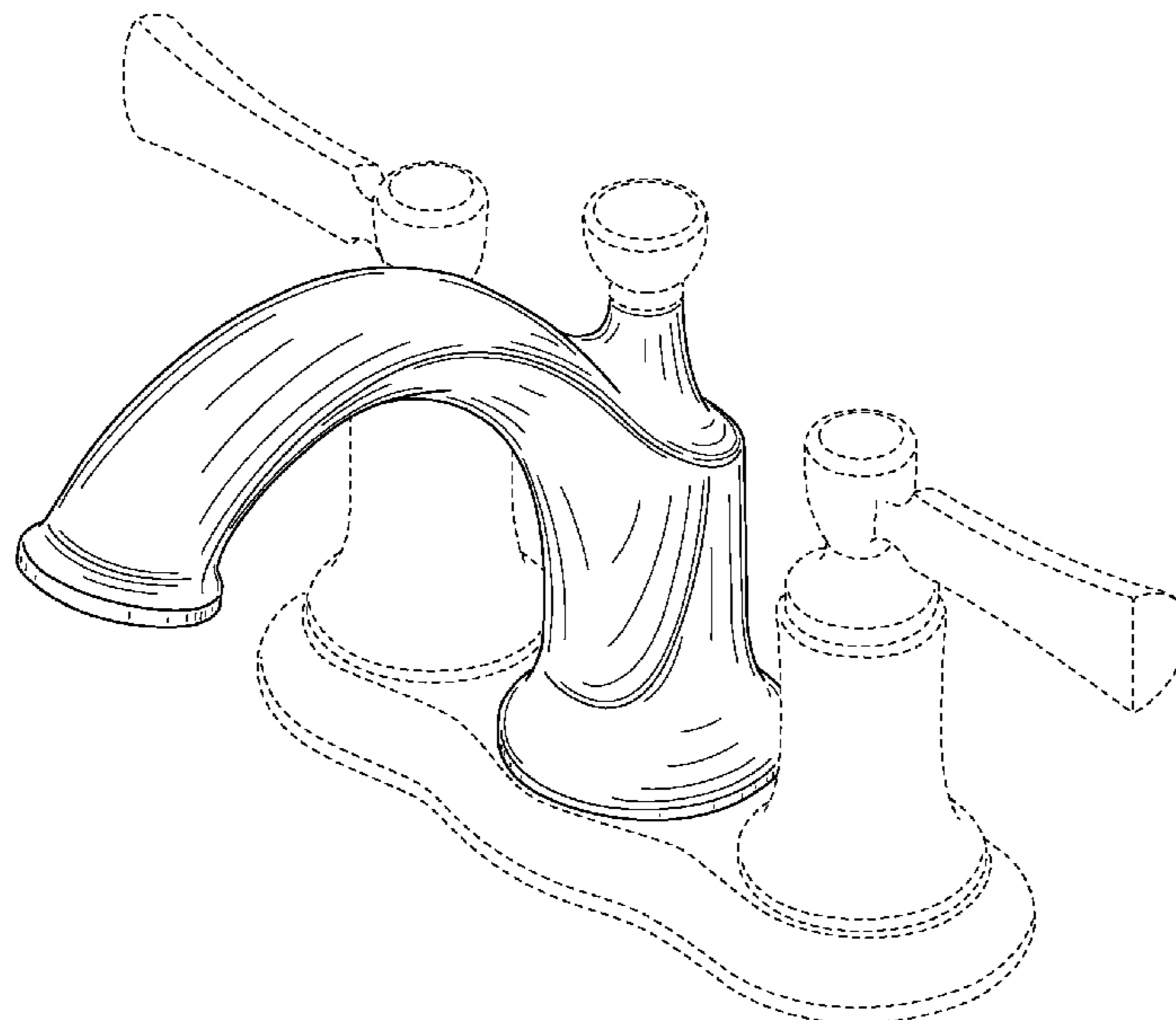

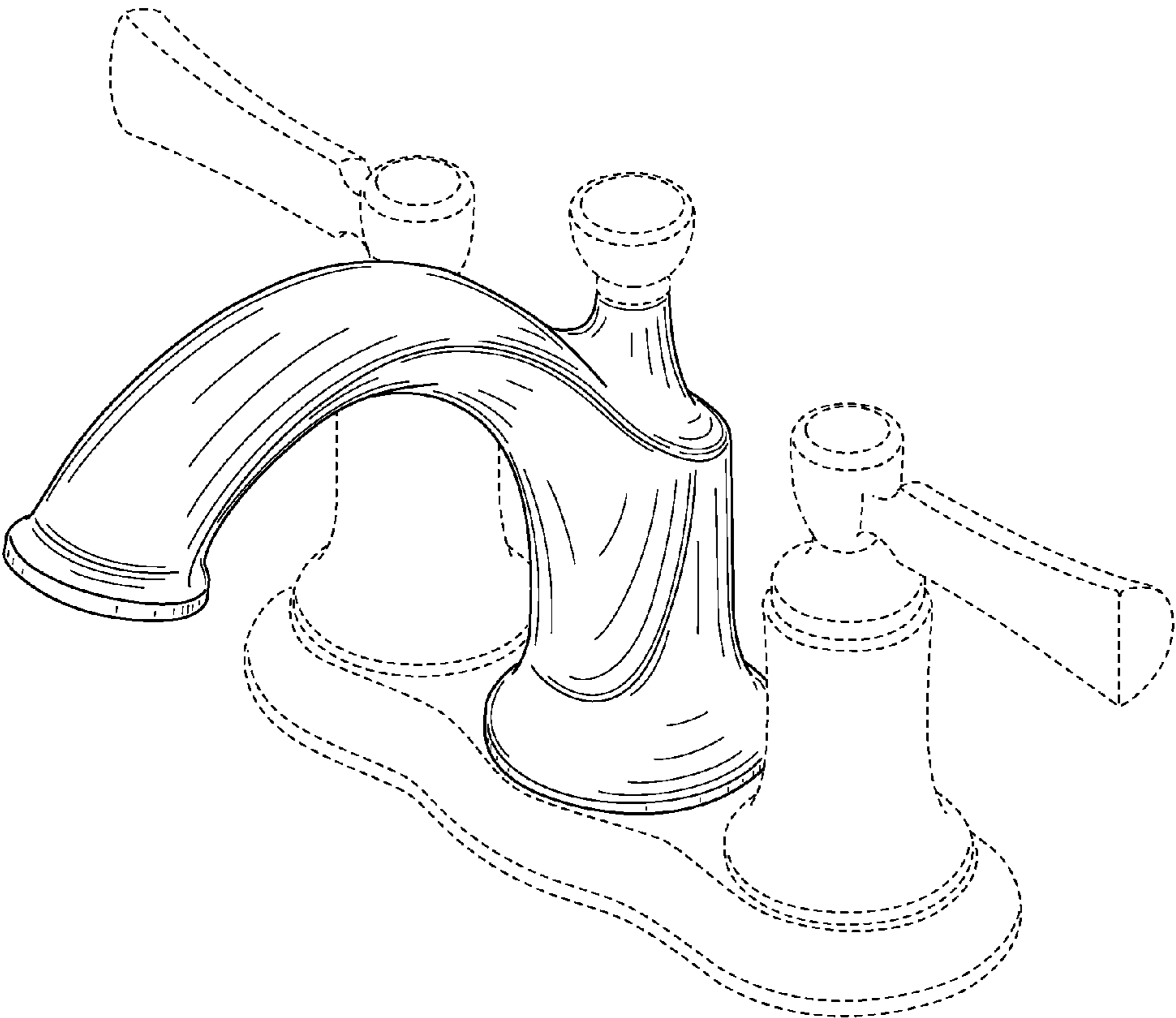

FIG. 1

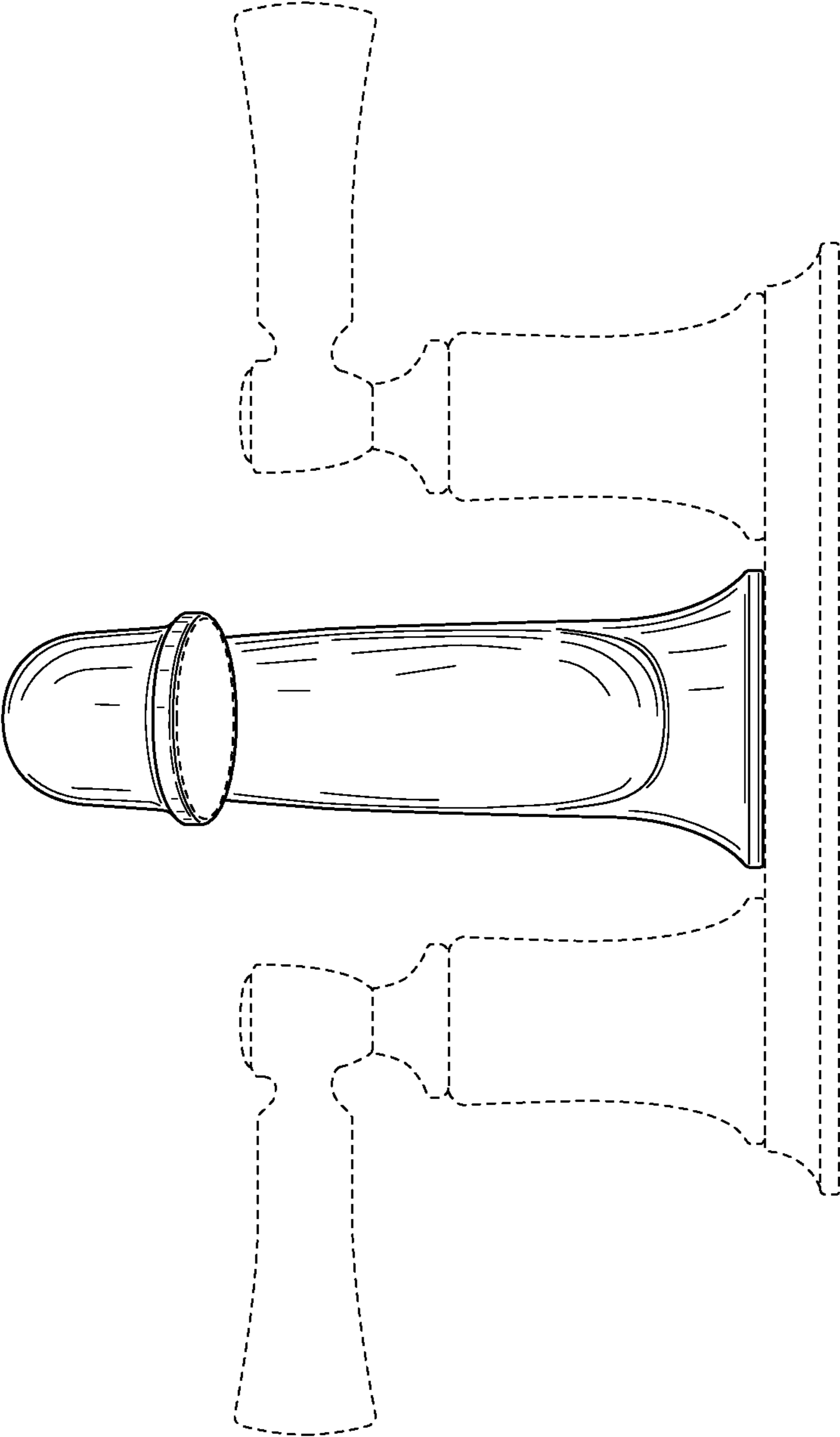

FIG. 2

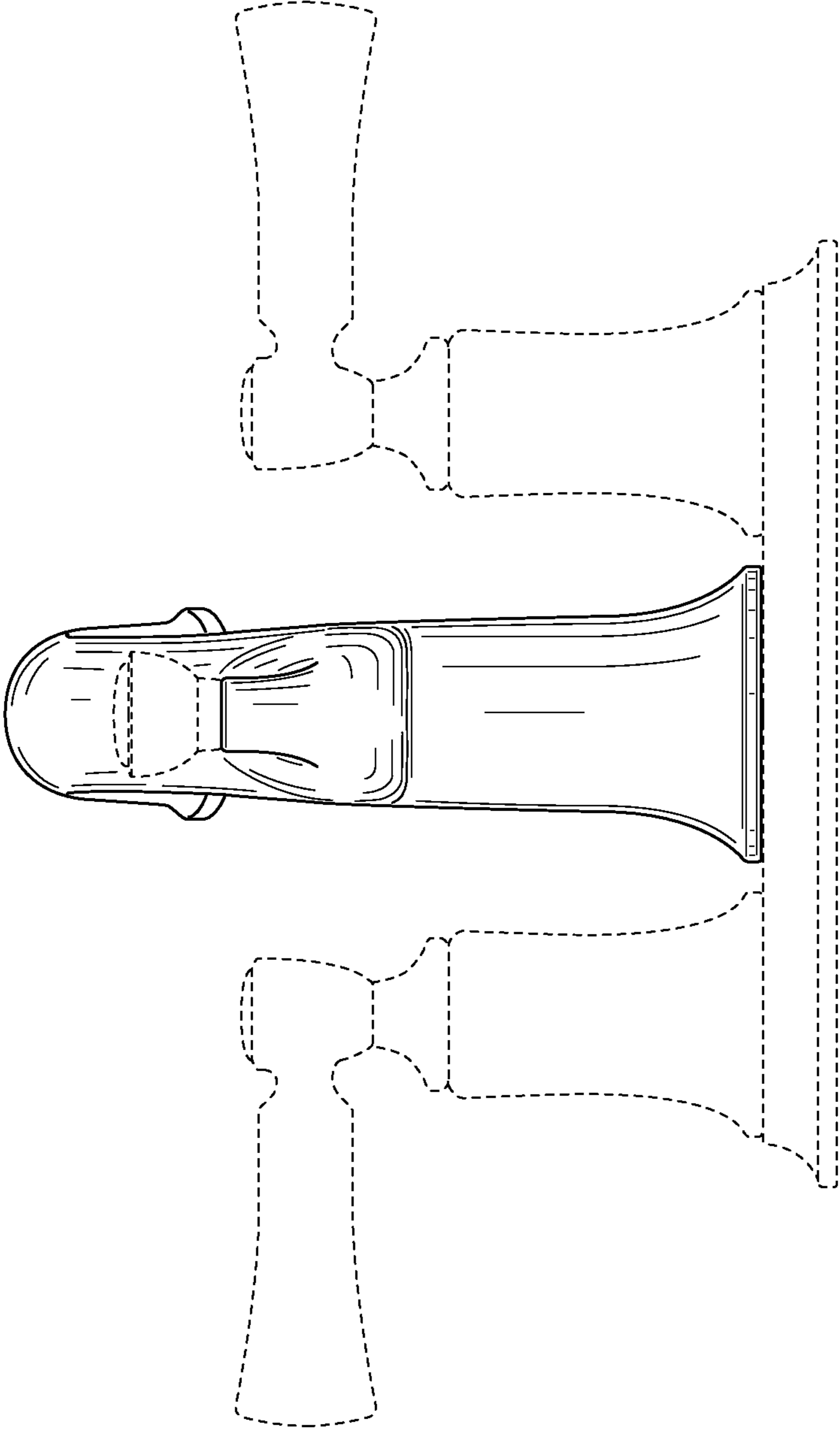

FIG. 3

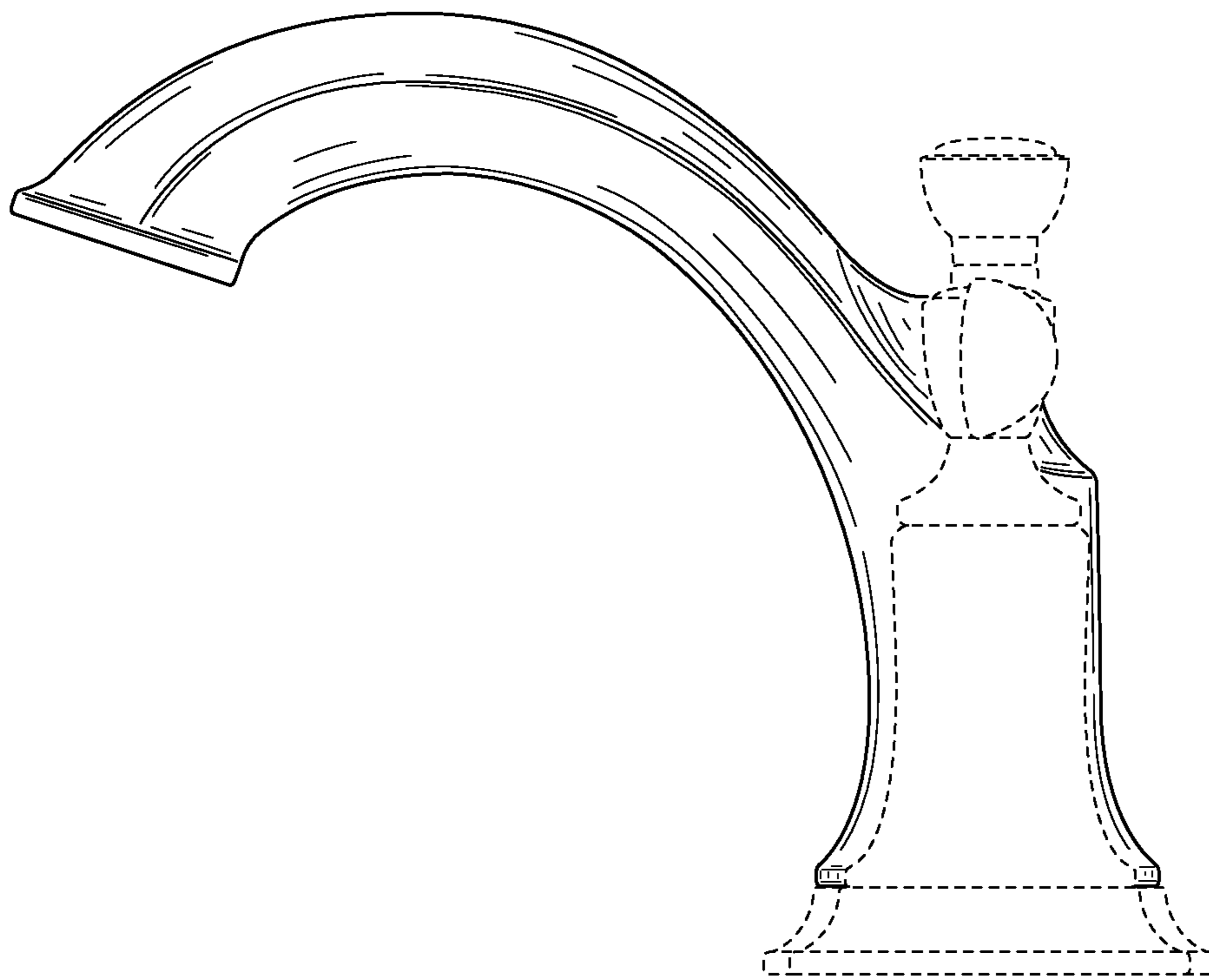

FIG. 4

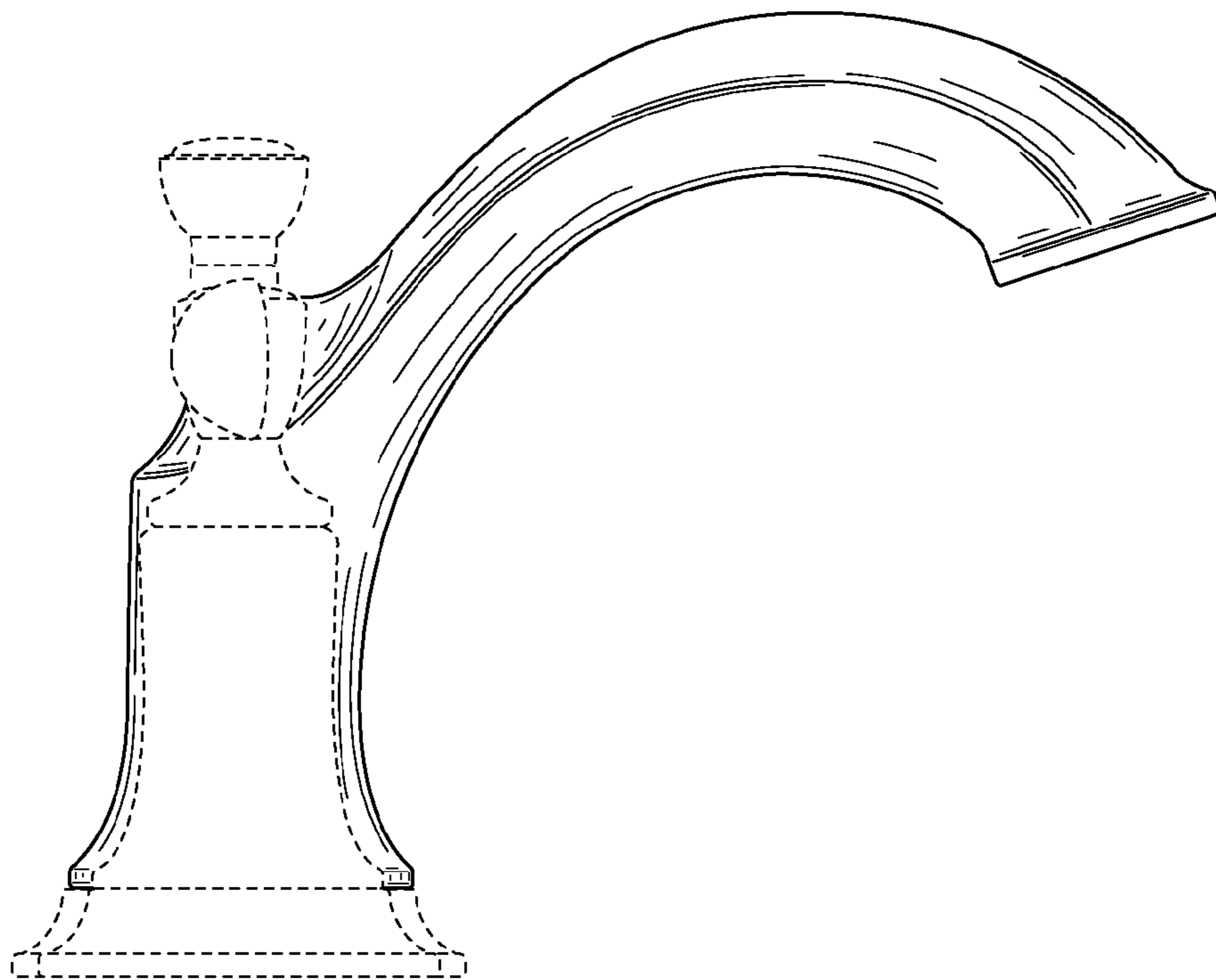

FIG. 5

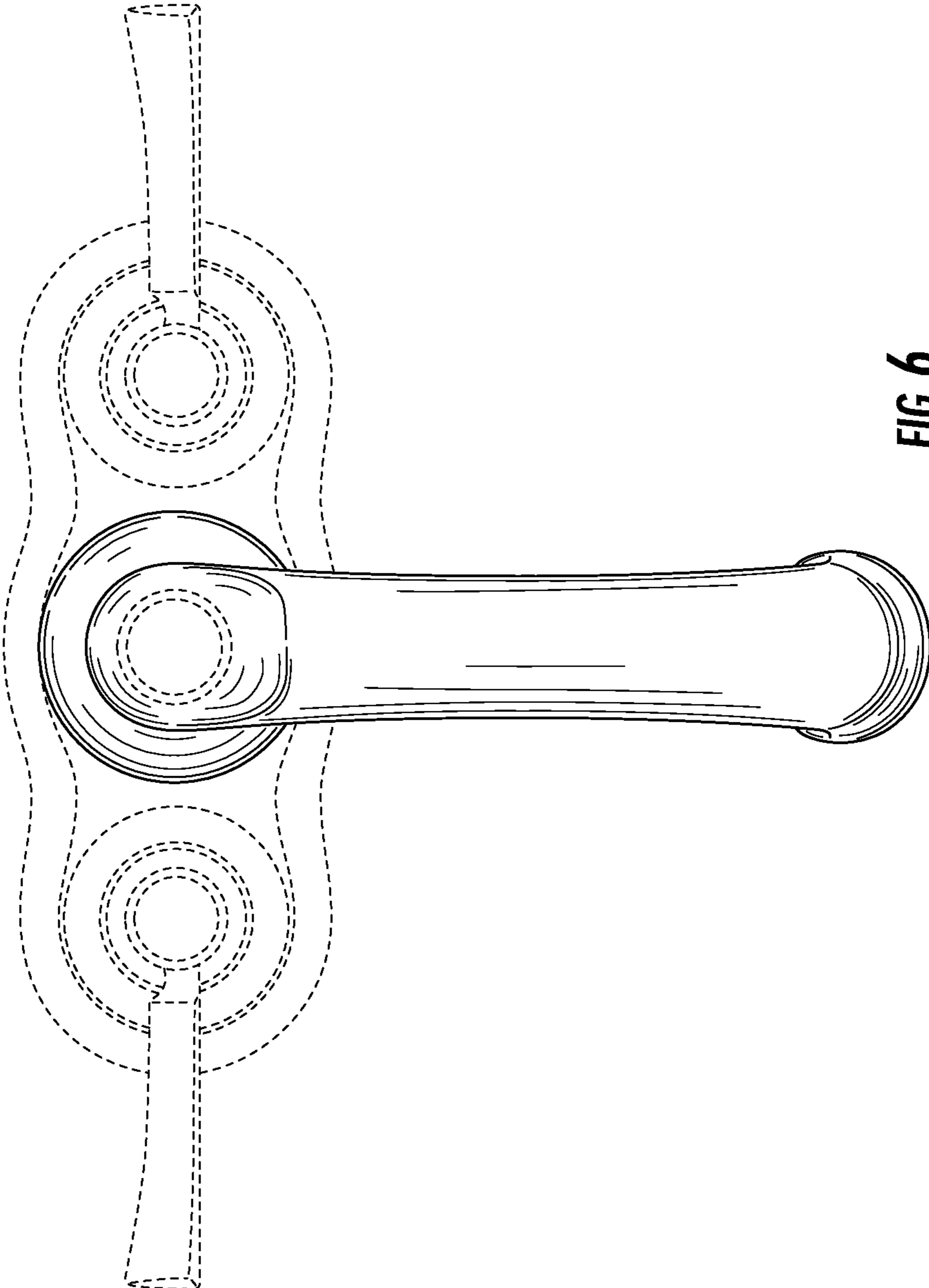

FIG. 6

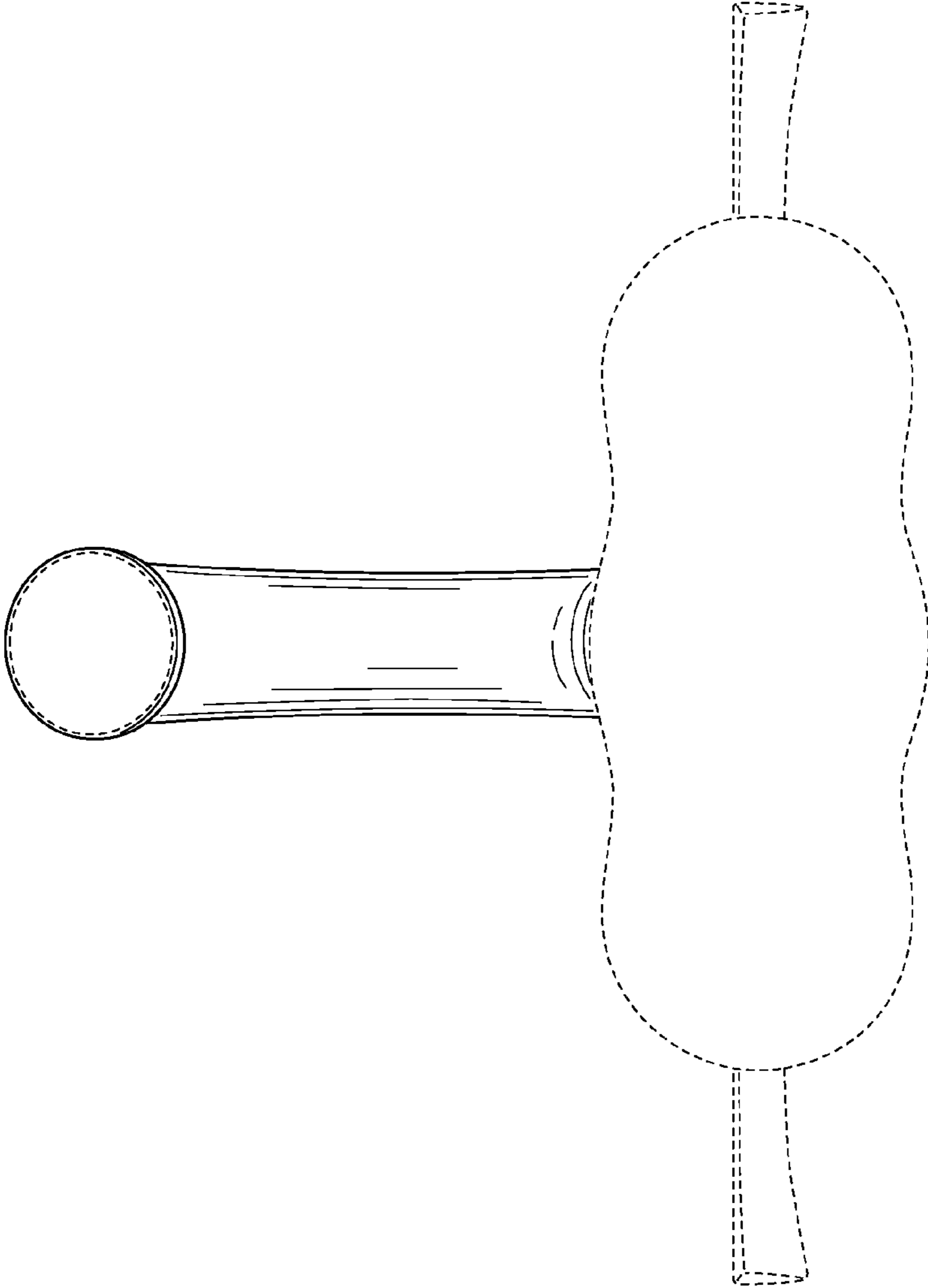

FIG. 7

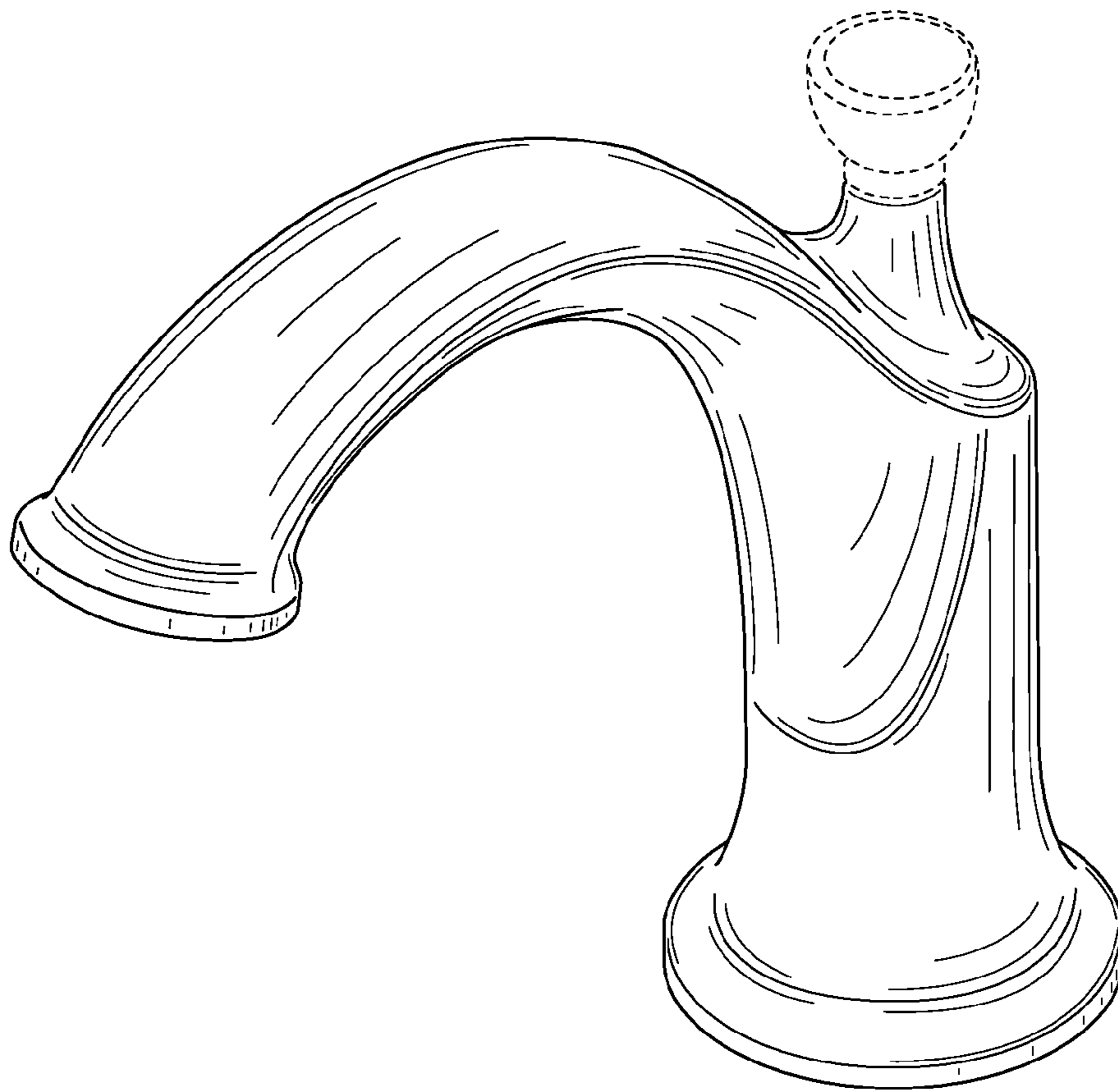

FIG. 8

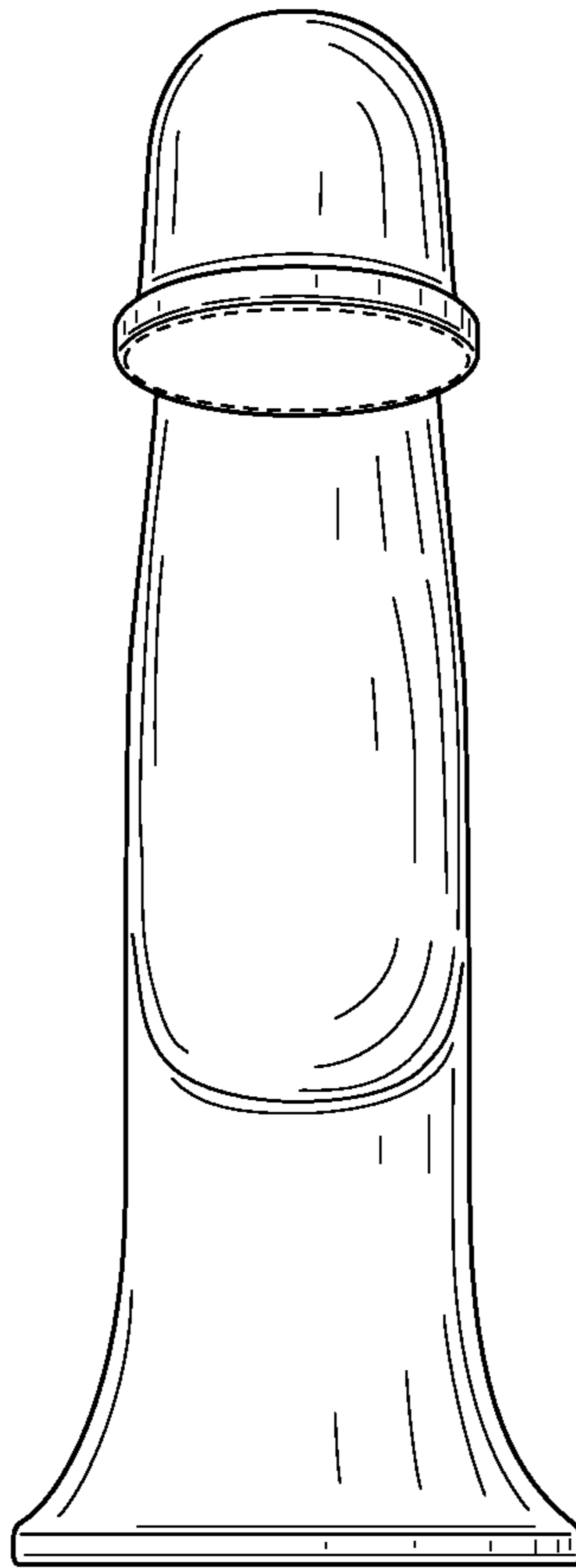

FIG. 9

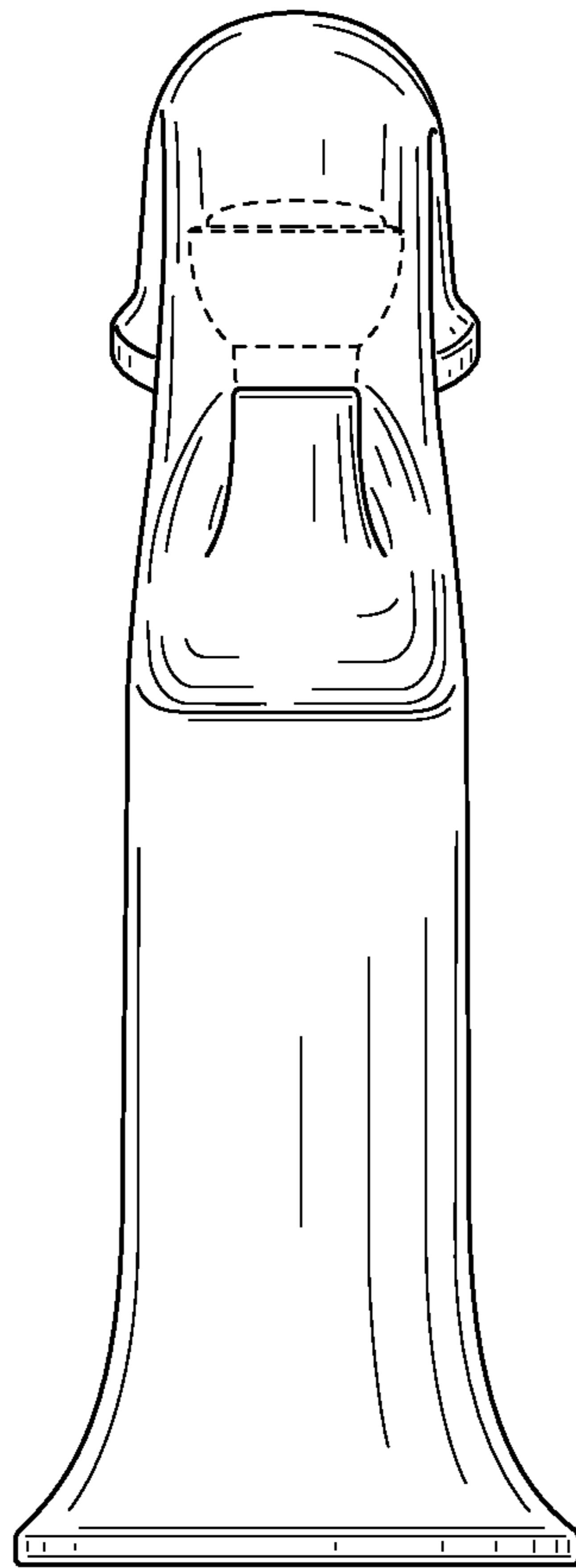

FIG. 10

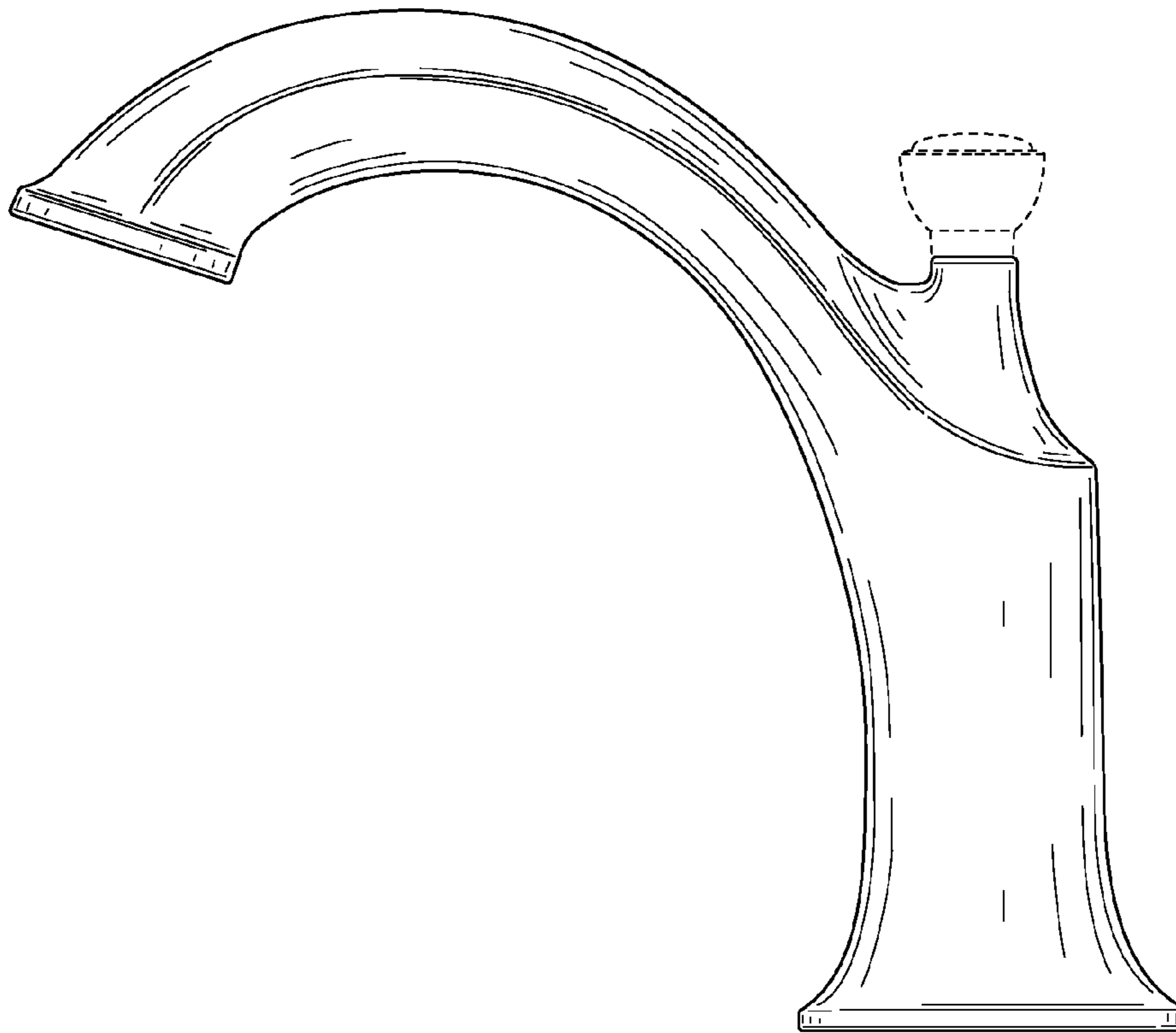

FIG. 11

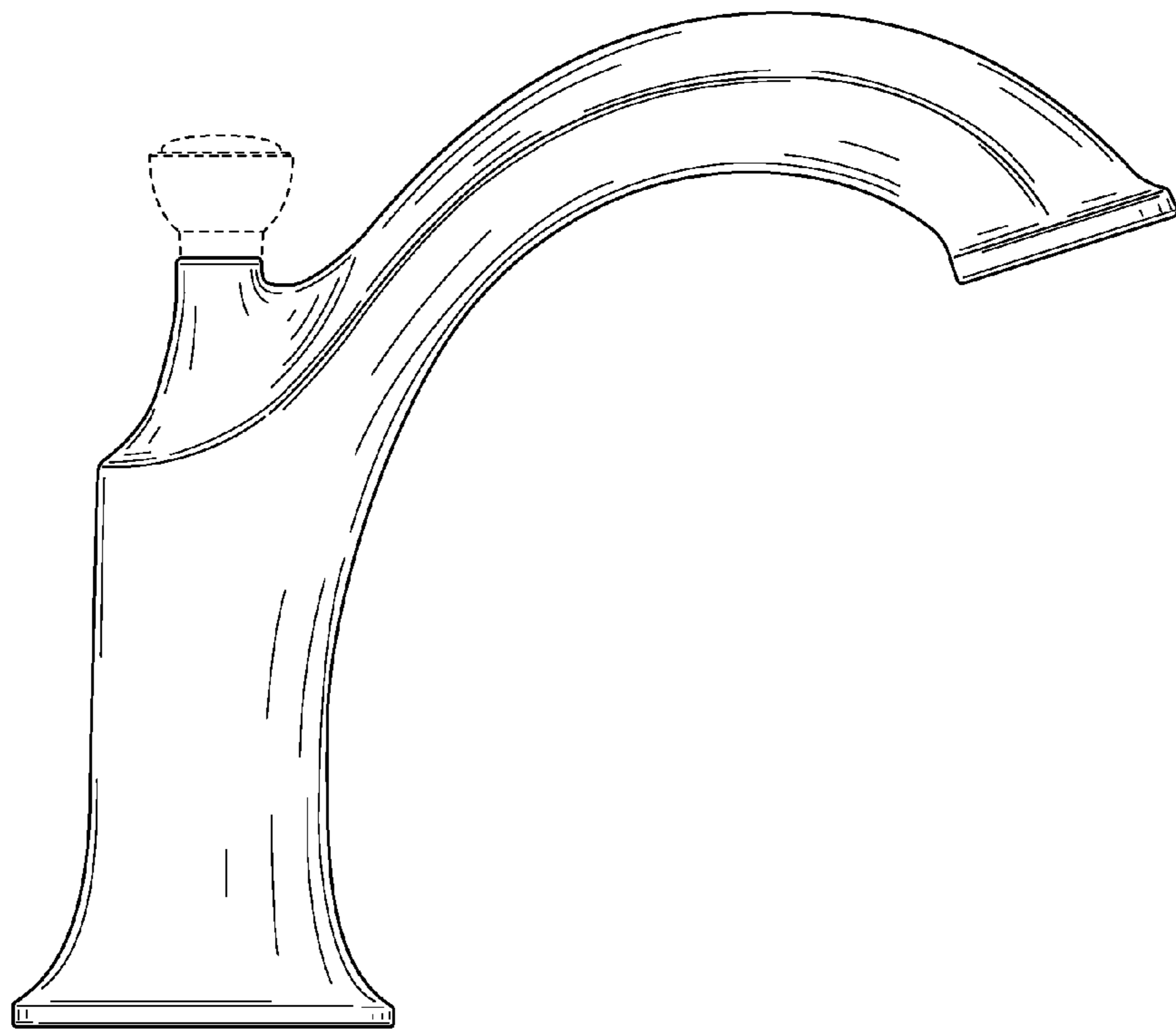

FIG. 12

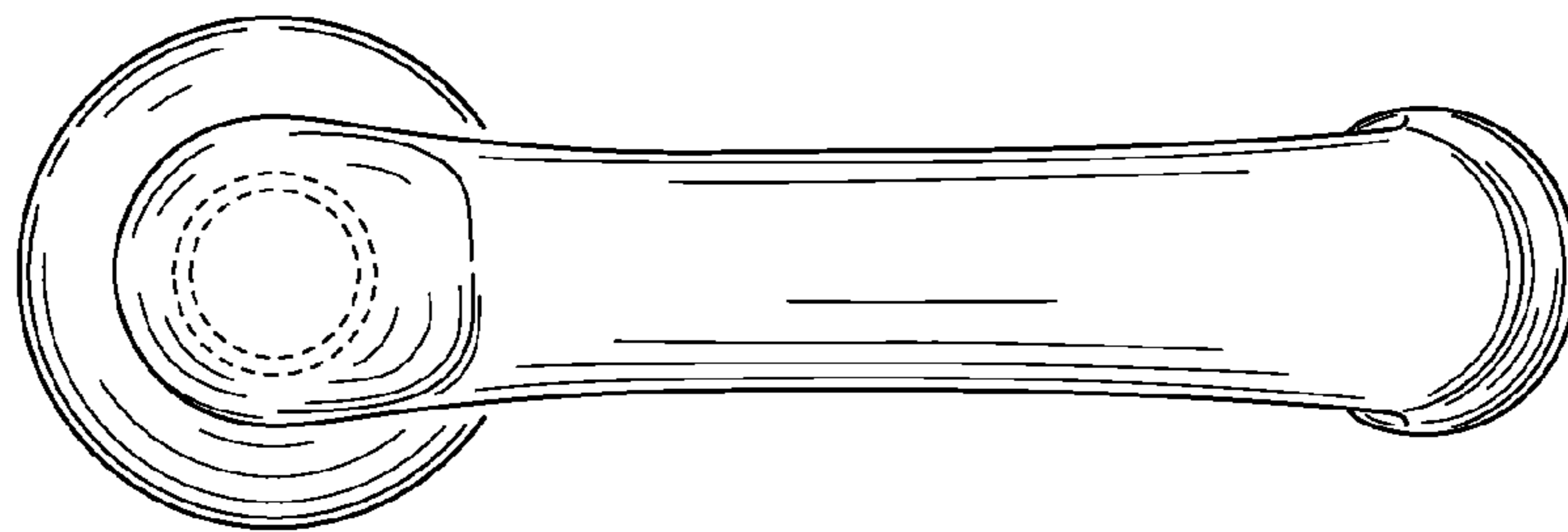

FIG. 13

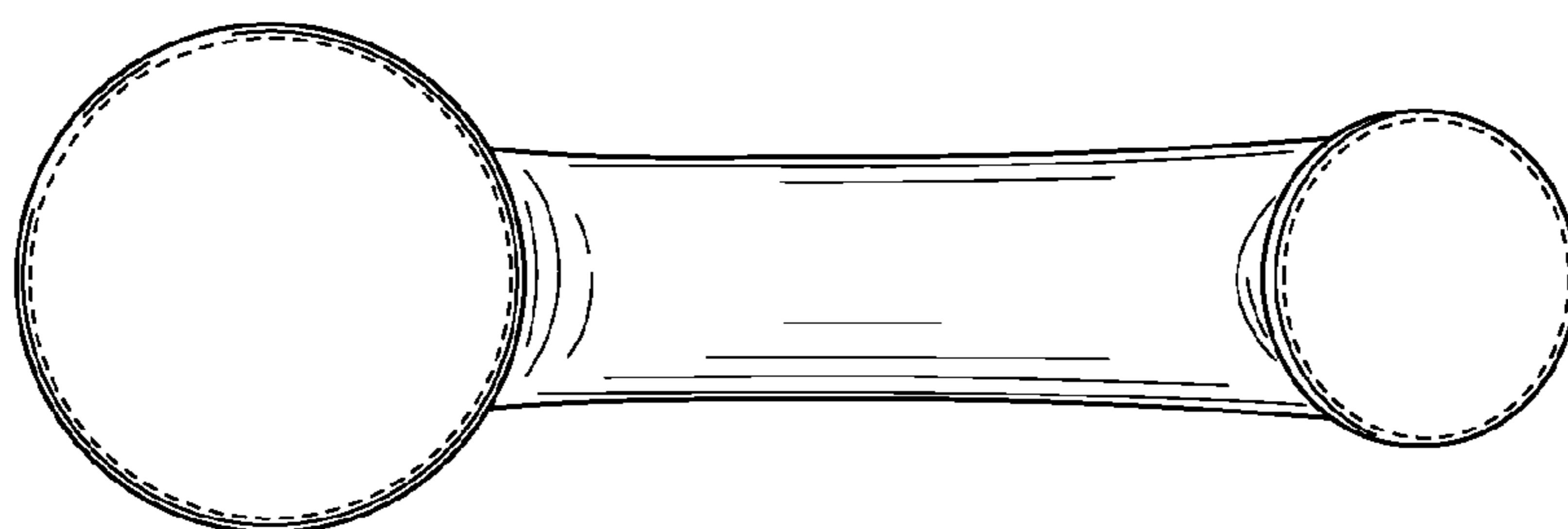

FIG. 14