



US00D697047S

(12) **United States Design Patent**
Yoshida

(10) **Patent No.:** **US D697,047 S**
(45) **Date of Patent:** **** Jan. 7, 2014**

(54) **HEADPHONE**

(75) Inventor: **Shigenori Yoshida**, Tokyo (JP)

(73) Assignee: **Sony Corporation**, Tokyo (JP)

(**) Term: **14 Years**

(21) Appl. No.: **29/421,448**

(22) Filed: **Jul. 30, 2012**

(51) **LOC (10) Cl.** **14-01**

(52) **U.S. Cl.**
USPC **D14/205**

(58) **Field of Classification Search**
USPC D14/205, 206, 215, 216, 217, 218, 219;
D29/112; 2/209; 181/129, 130, 135,
181/136; 379/430, 431; 381/380, 381;
455/90.3, 575.1

See application file for complete search history.

(56) **References Cited**

U.S. PATENT DOCUMENTS

D328,461 S	8/1992	Daido et al.	
5,661,270 A *	8/1997	Bozorgi-Ram	181/129
D410,466 S	6/1999	Mouri	
D435,249 S *	12/2000	Yasutomi	D14/205
D502,938 S *	3/2005	Tokioka et al.	D14/205
D504,883 S *	5/2005	Jacobson et al.	D14/192
D512,981 S *	12/2005	Jacobson et al.	D14/205
D517,043 S *	3/2006	Jacobson et al.	D14/205
D517,526 S	3/2006	Komiyama	
D517,527 S *	3/2006	Suzuki	D14/205
D518,474 S	4/2006	Suzuki	
D532,407 S	11/2006	Motoishi	
D588,098 S *	3/2009	Kurihara	D14/205
D594,847 S *	6/2009	Suzuki	D14/205

D603,370 S *	11/2009	Suzuki	D14/205
D639,776 S *	6/2011	Arimoto	D14/205
8,098,872 B2 *	1/2012	Chang	381/371
D674,767 S *	1/2013	Brunner et al.	D14/205

* cited by examiner

Primary Examiner — Paula Greene

(74) *Attorney, Agent, or Firm* — Rader, Fishman & Grauer PLLC

(57) **CLAIM**

The ornamental design for a headphone, as shown and described.

DESCRIPTION

FIG. 1 is a perspective view of a headphone showing my new design;
 FIG. 2 is a front elevational view thereof;
 FIG. 3 is a rear elevational view thereof;
 FIG. 4 is a left side elevational view thereof;
 FIG. 5 is a right side elevational view thereof;
 FIG. 6 is a top plan view thereof; and
 FIG. 7 is a bottom plan view thereof.
 FIG. 8 is a perspective view of another embodiment of a headphone showing my new design;
 FIG. 9 is a front elevational view thereof;
 FIG. 10 is a rear elevational view thereof;
 FIG. 11 is a left side elevational view thereof;
 FIG. 12 is a right side elevational view thereof; and
 FIG. 13 is a top plan view thereof; and,
 FIG. 14 is a bottom plan view thereof.
 The broken lines form no part of the claimed design.

1 Claim, 14 Drawing Sheets

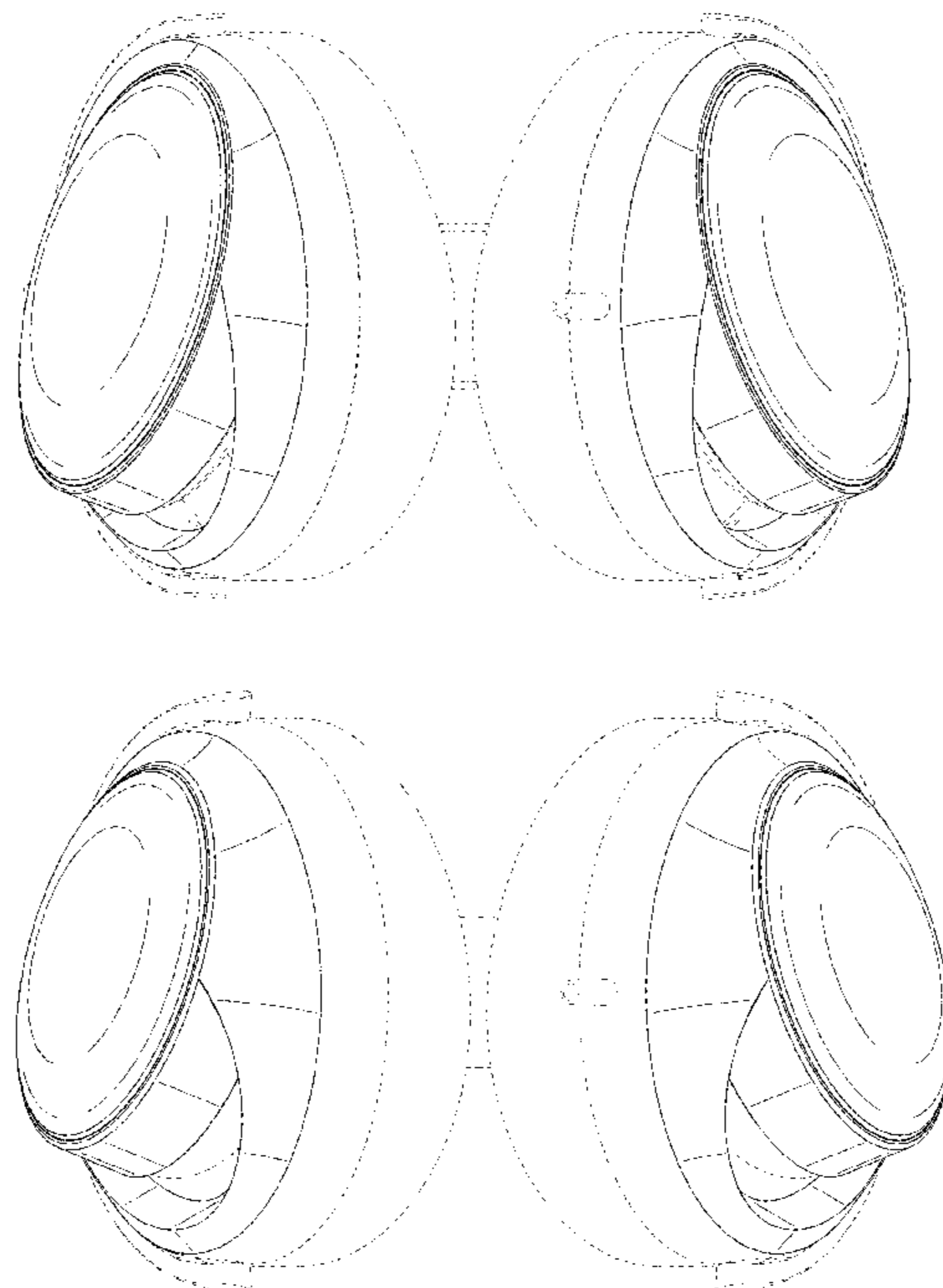

FIG.1

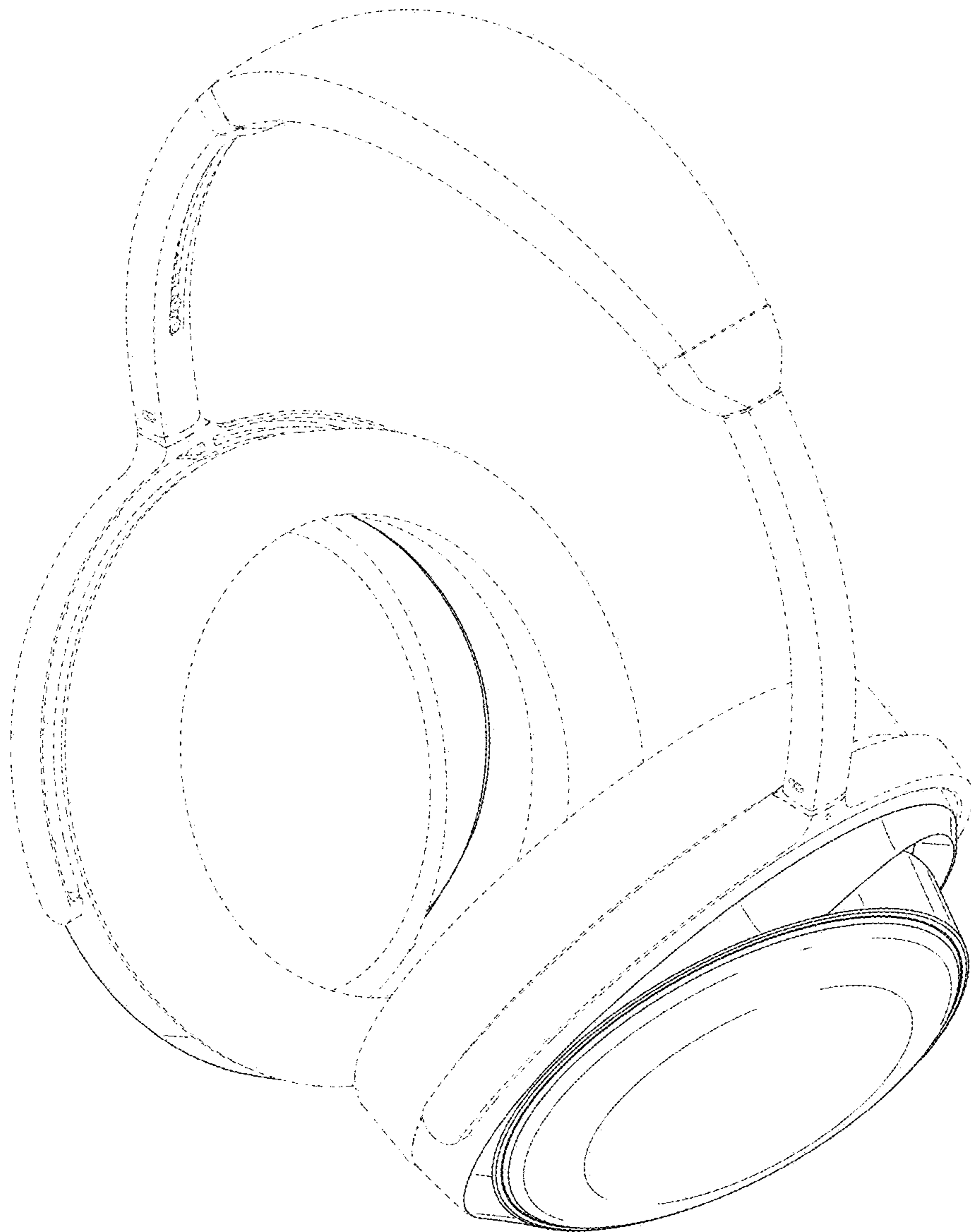

FIG.2

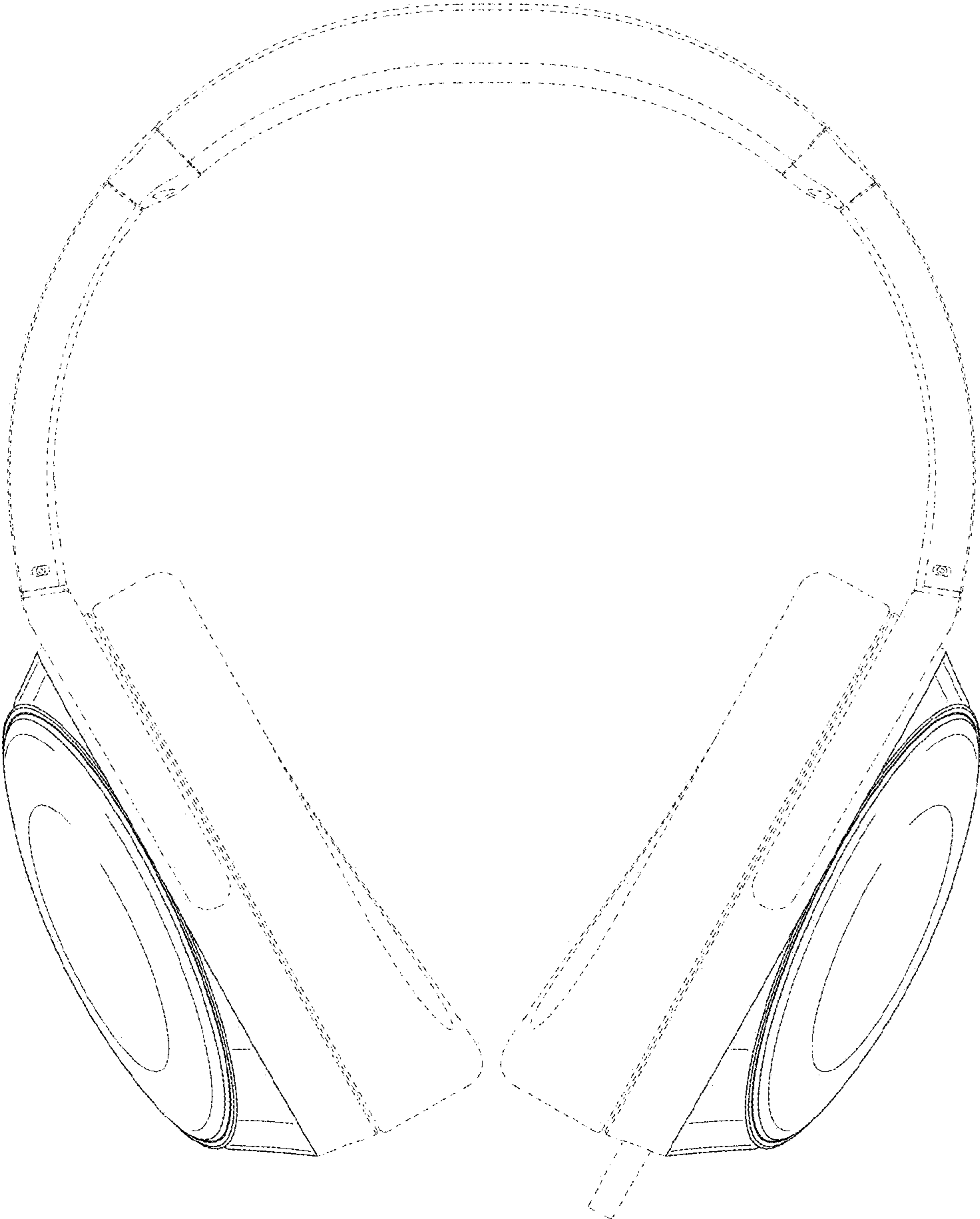

FIG.3

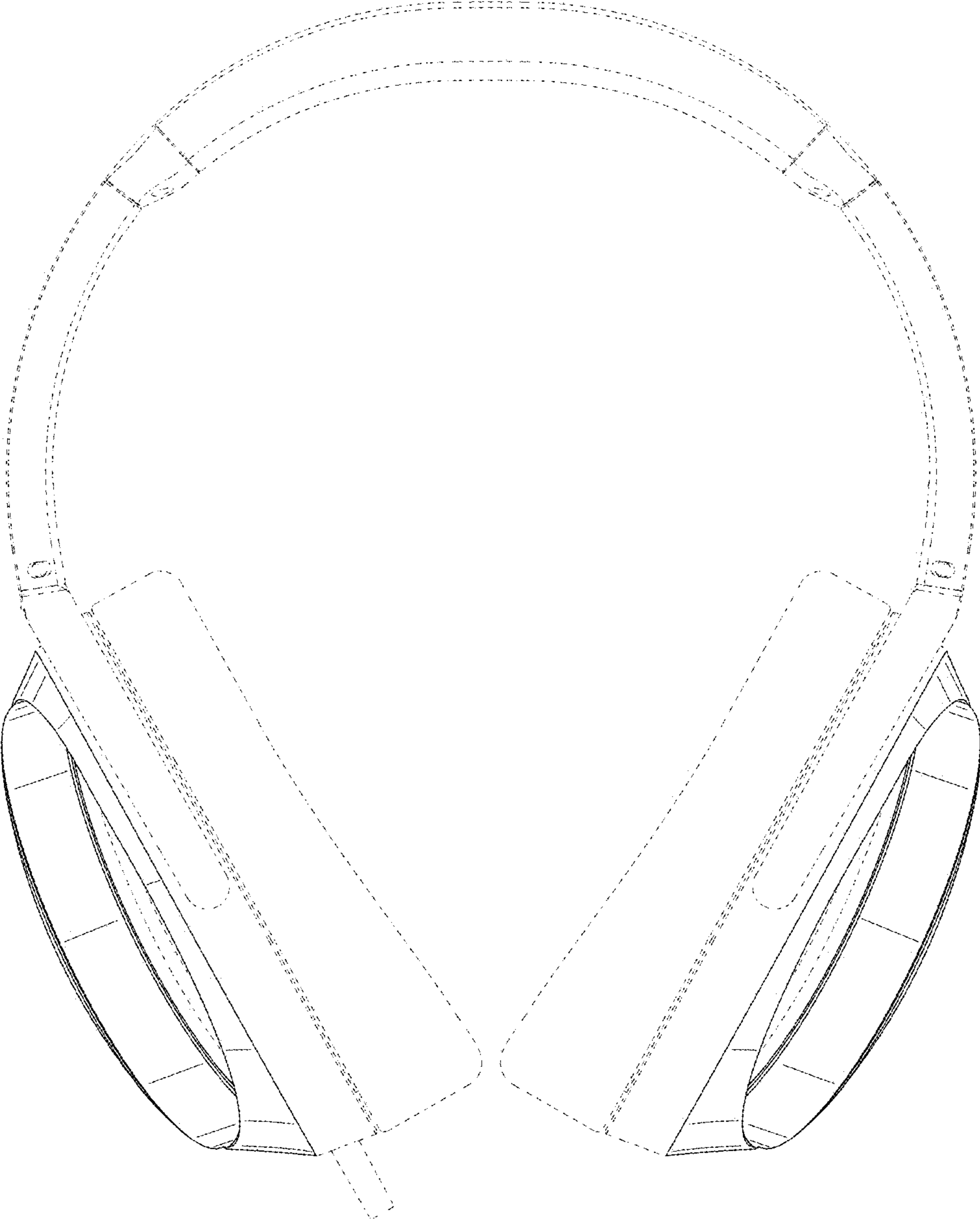

FIG.4

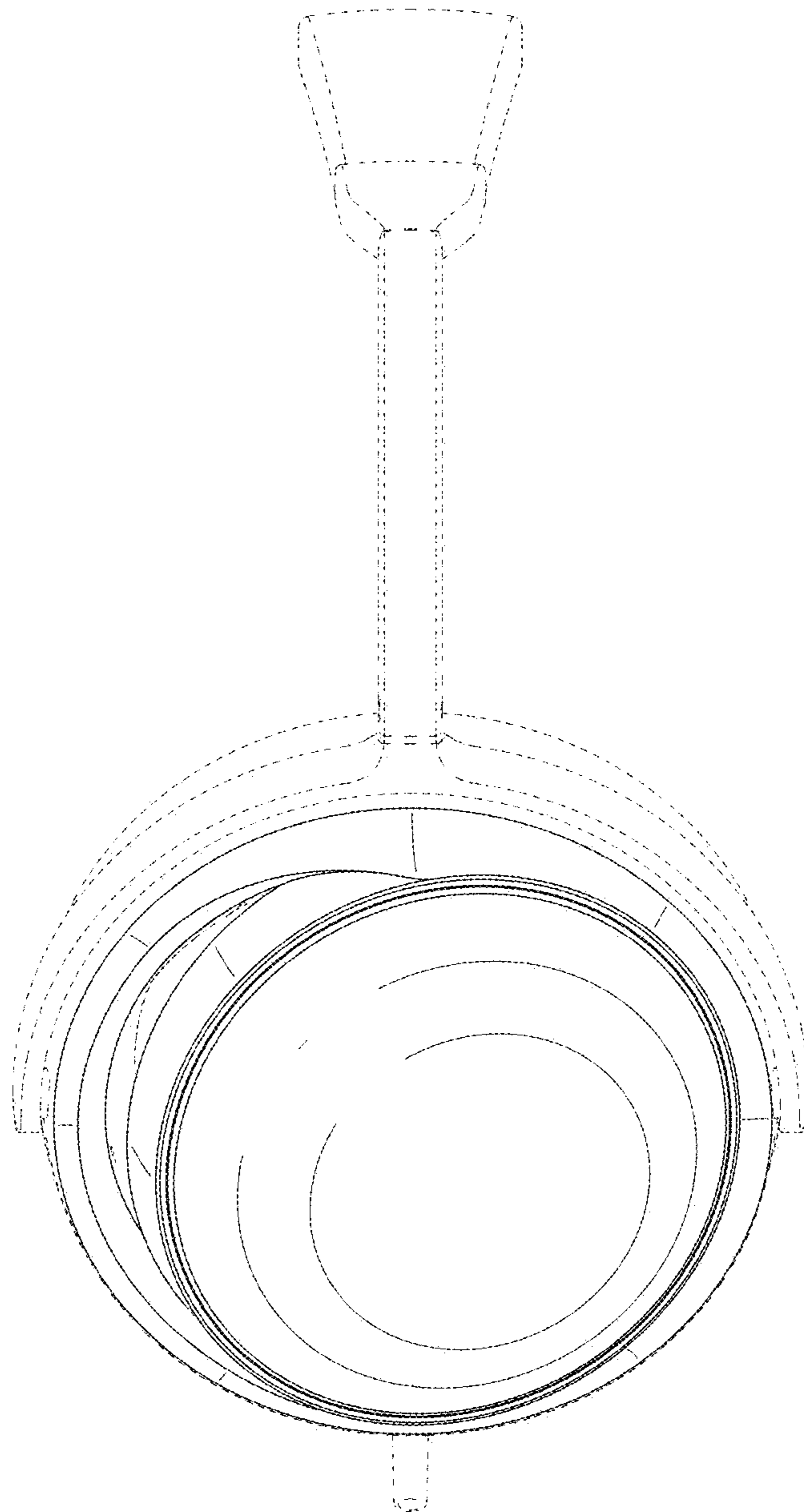

FIG.5

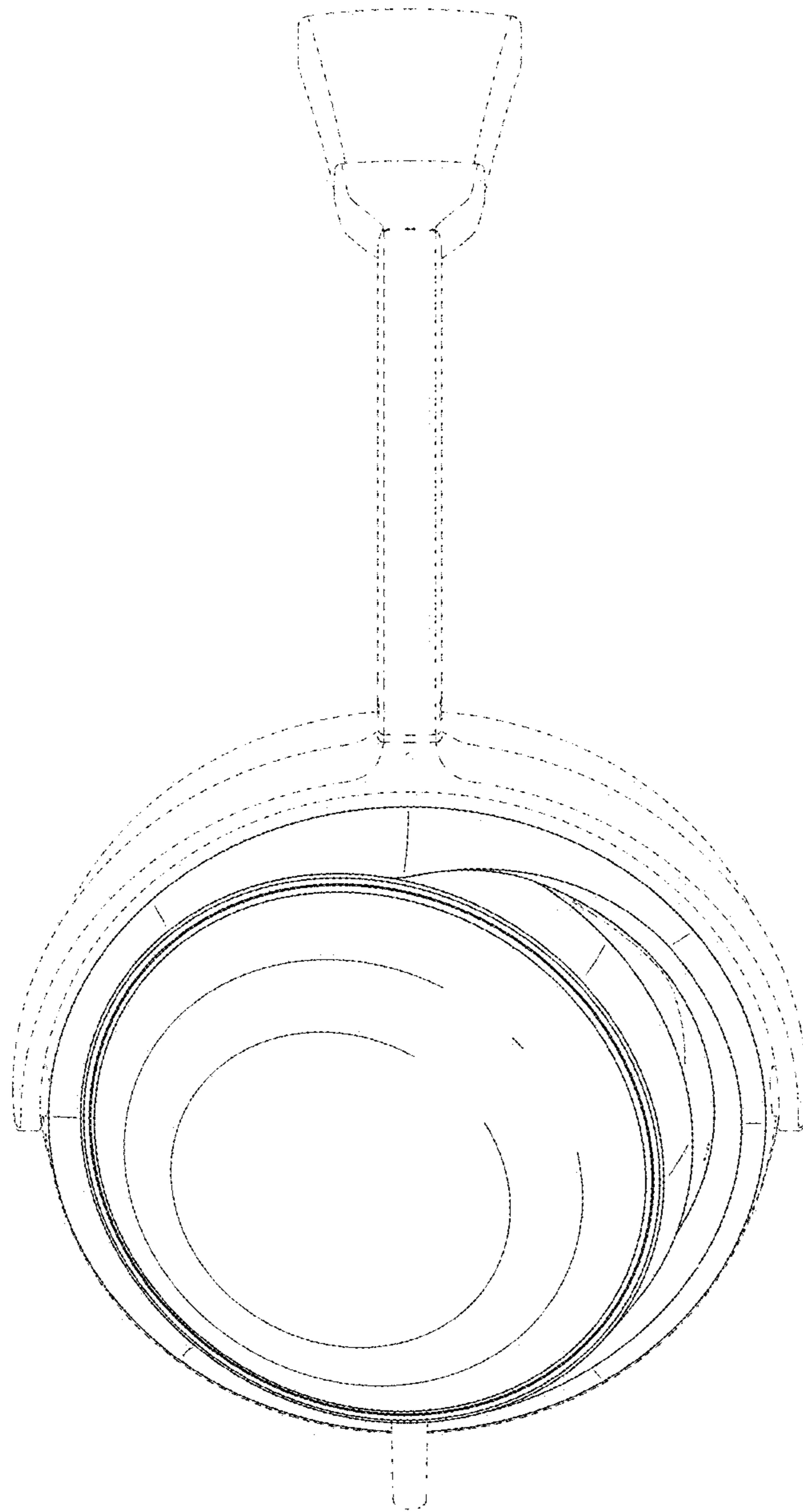

FIG.6

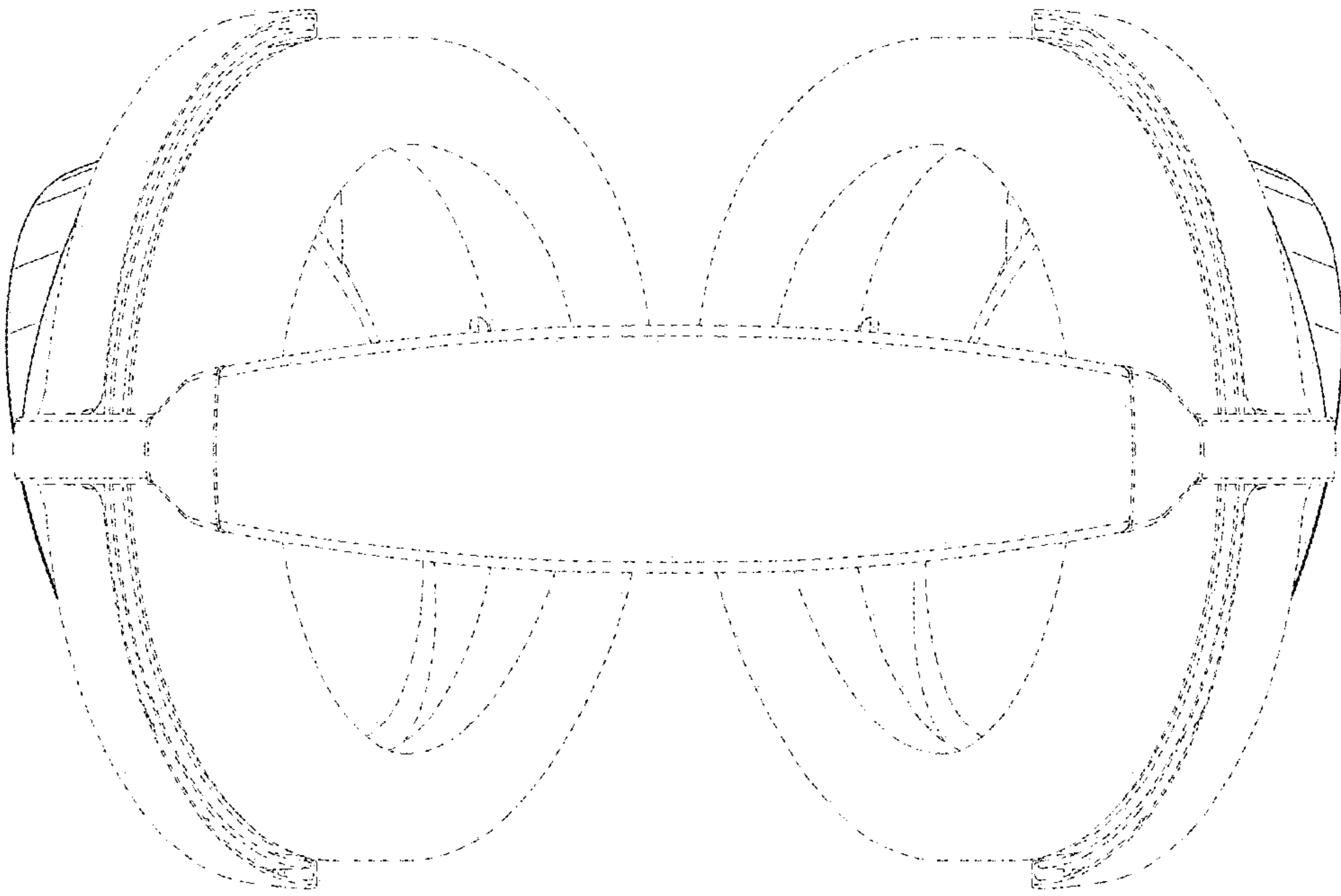

FIG.7

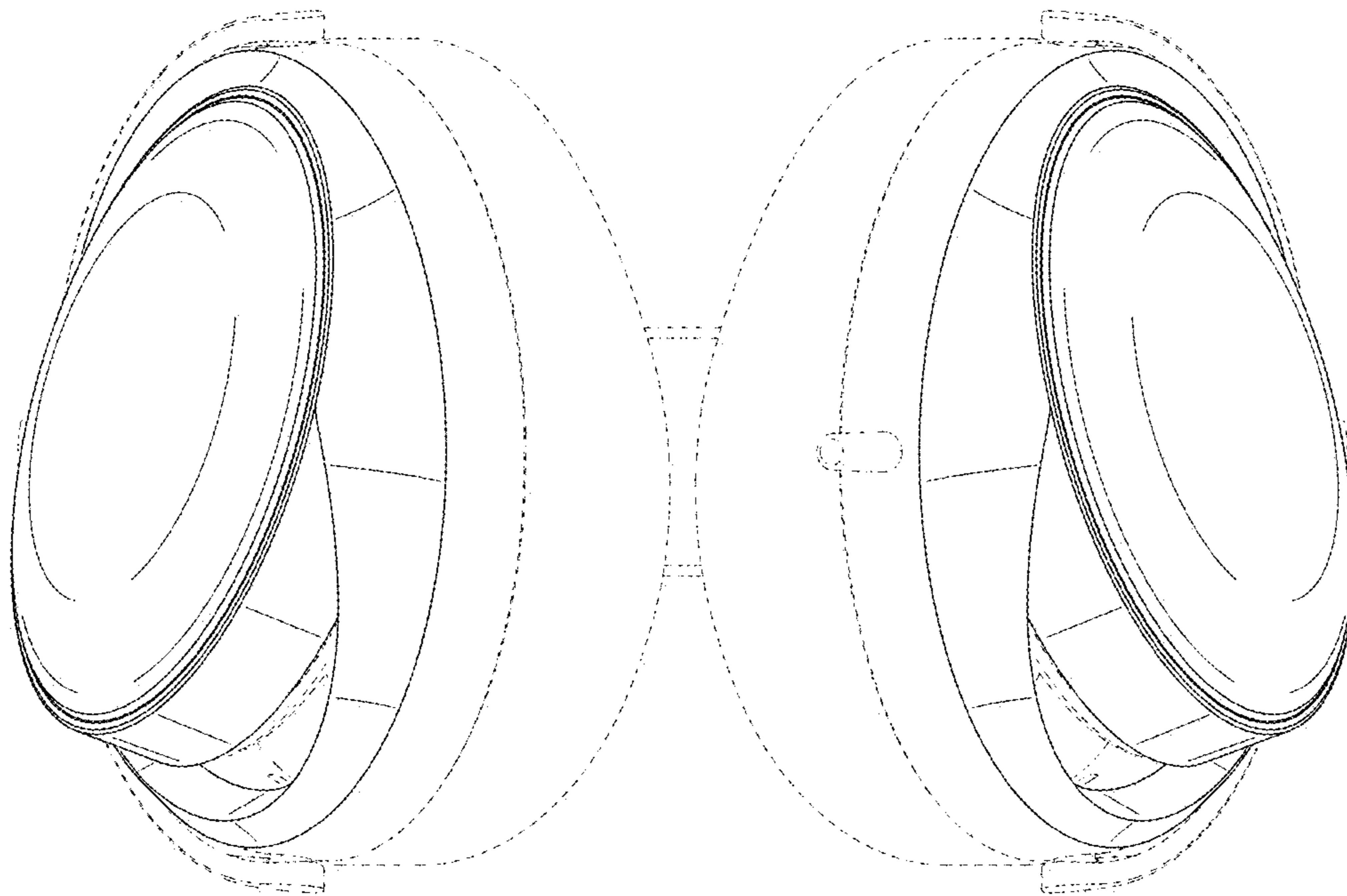

FIG.8

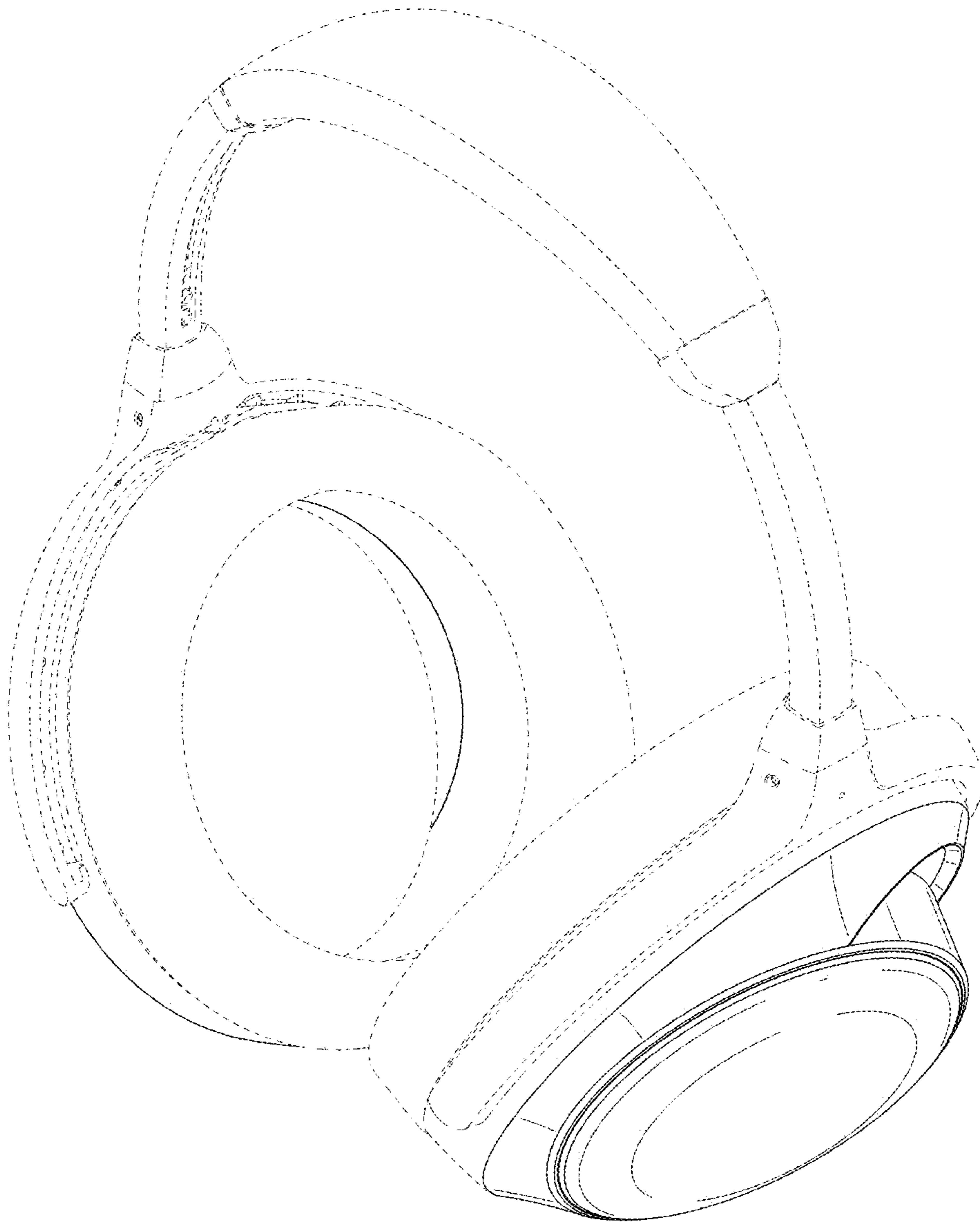

FIG.9

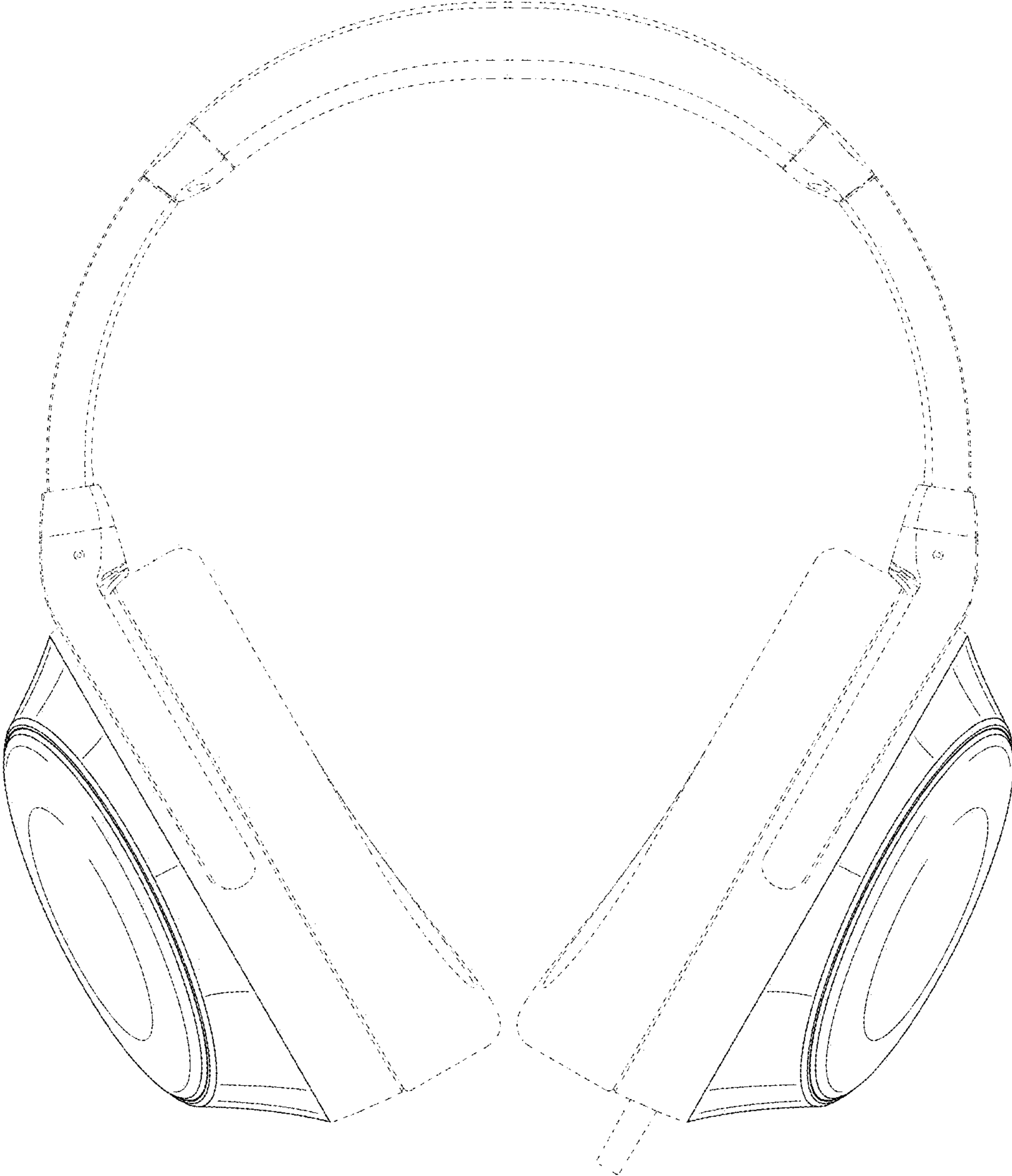

FIG.10

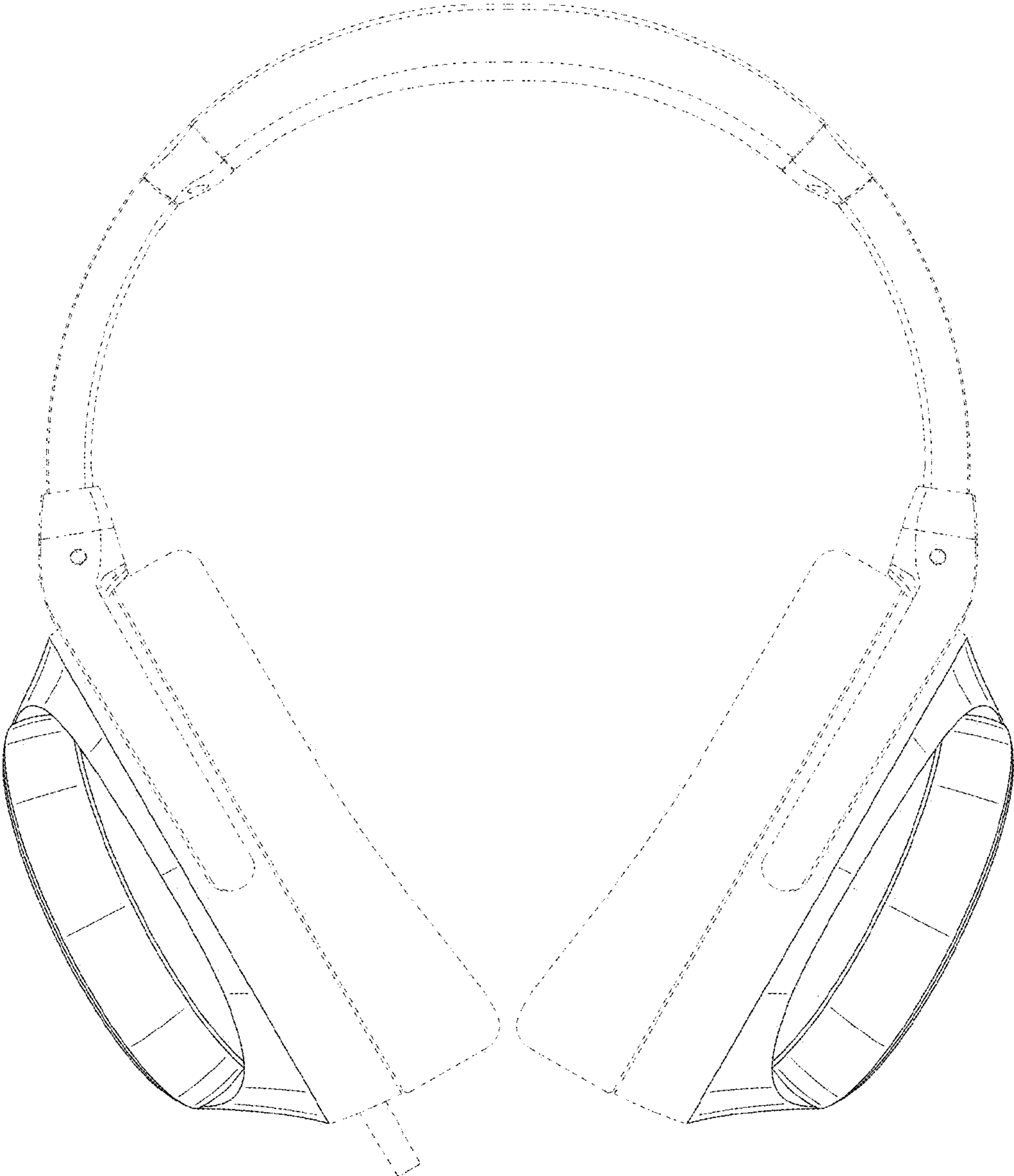

FIG. 11

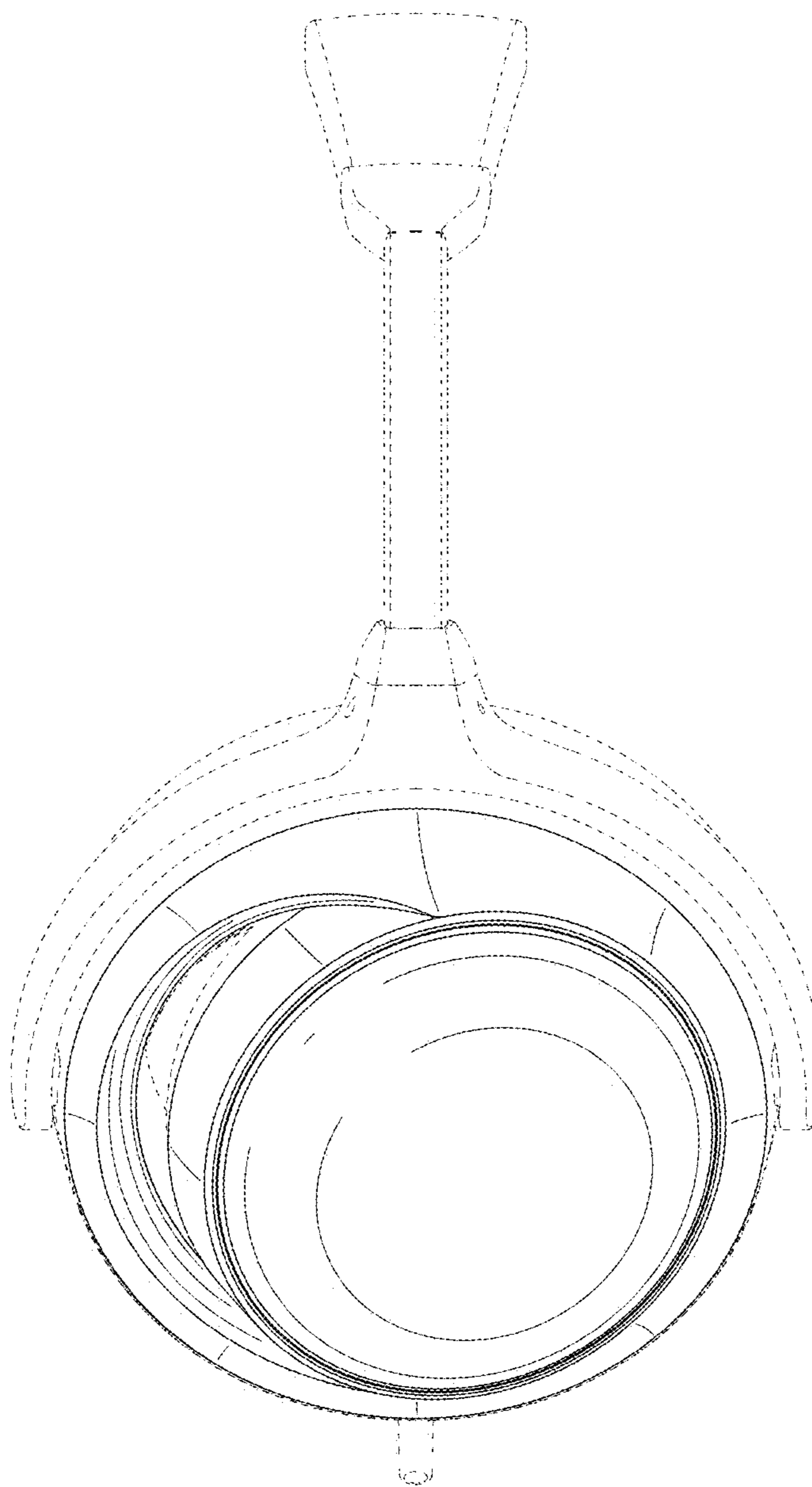

FIG. 12

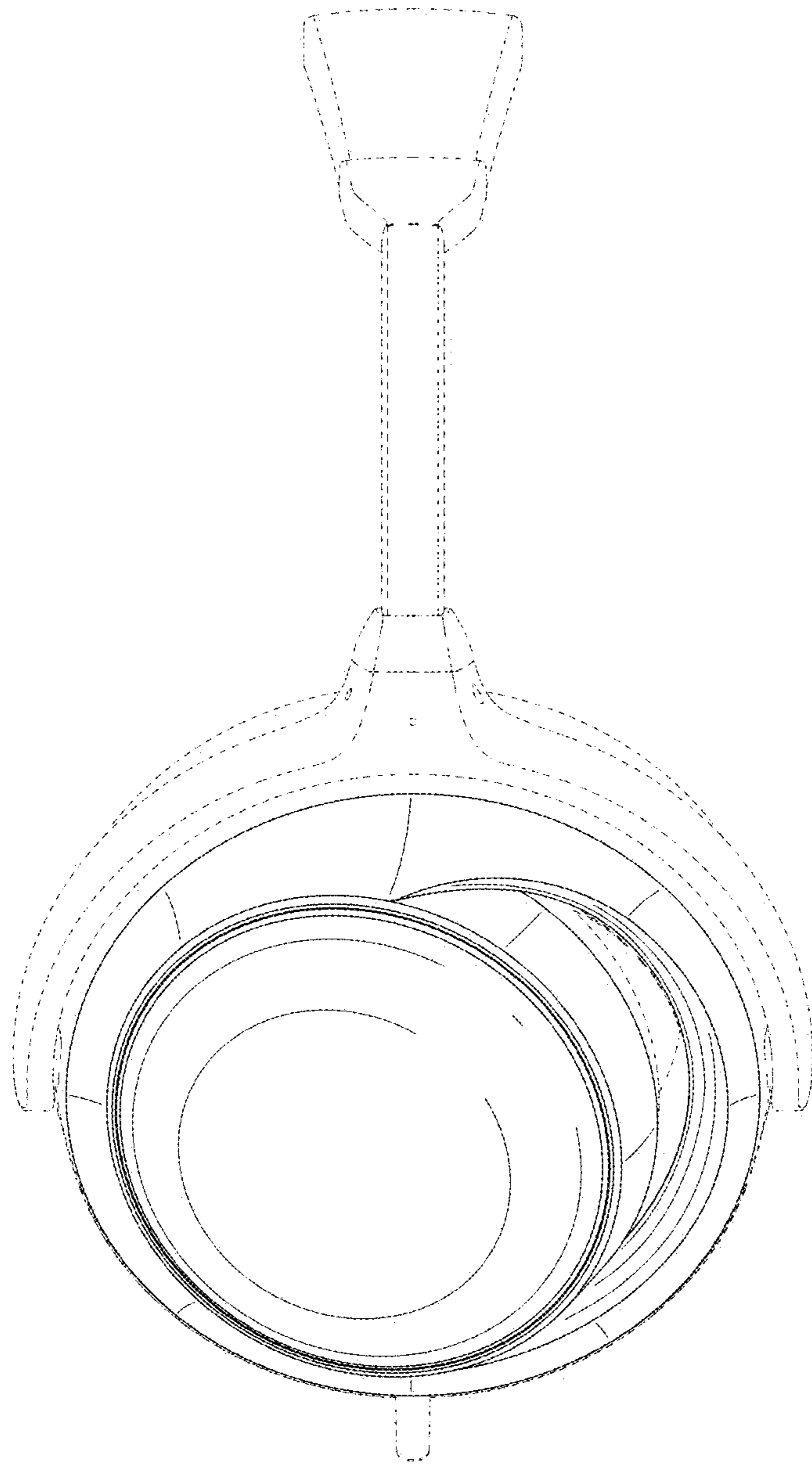

FIG. 13

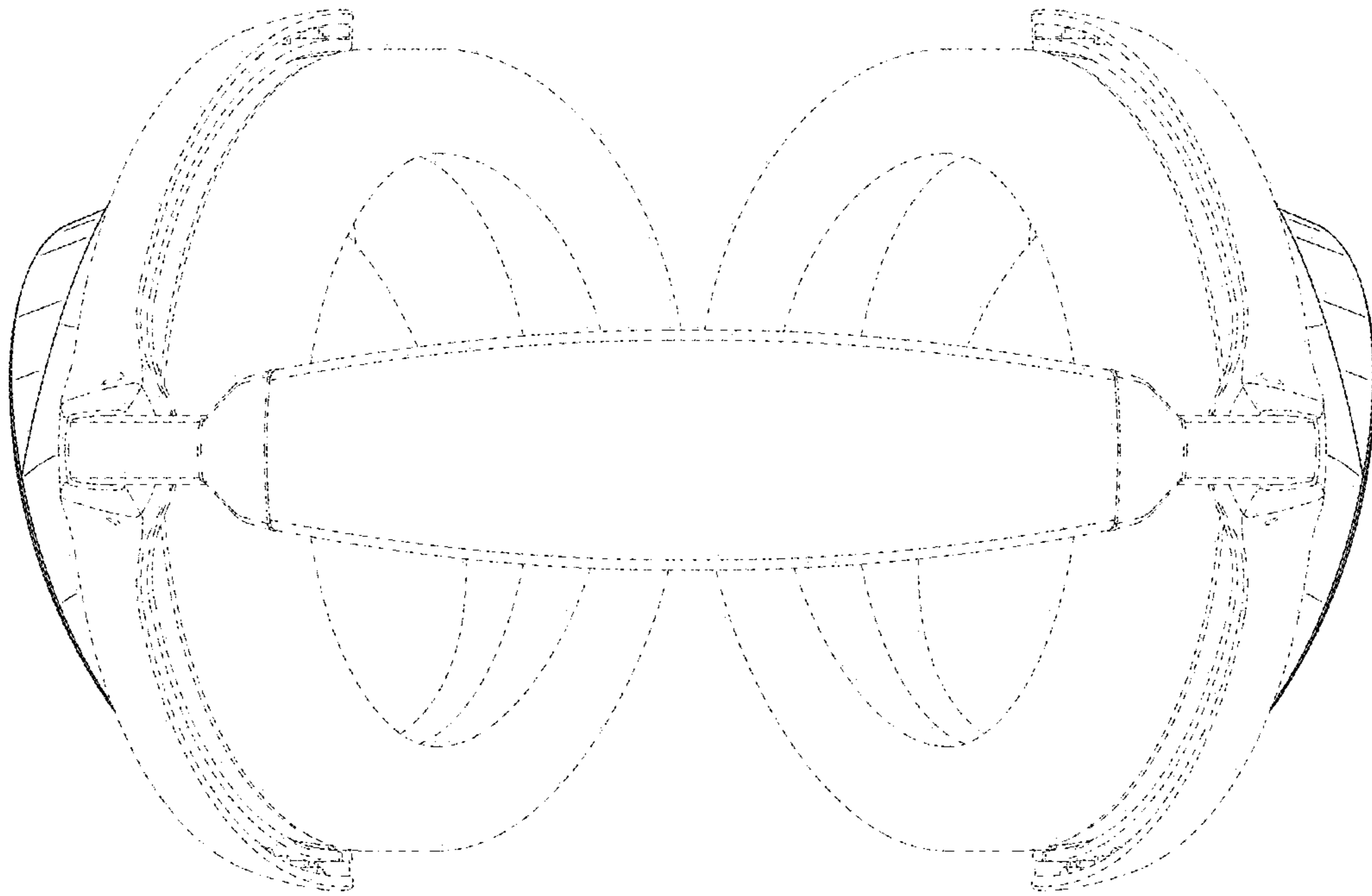

FIG.14

