

US00D696884S

(12) **United States Design Patent**  
**Skalka**

(10) **Patent No.:** **US D696,884 S**  
(45) **Date of Patent:** **\*\* Jan. 7, 2014**

- (54) **MODULAR SEAT COMPONENT**
- (71) Applicant: **Victor Stanley, Inc.**, Dunkirk, MD (US)
- (72) Inventor: **Gerald Skalka**, Potomac, MD (US)
- (73) Assignee: **Victor Stanley, Inc.**, Dunkirk, MD (US)
- (\*\*) Term: **14 Years**
- (21) Appl. No.: **29/461,065**
- (22) Filed: **Jul. 18, 2013**

**Related U.S. Application Data**

- (62) Division of application No. 29/397,523, filed on Jul. 18, 2011.
- (51) **LOC (10) Cl.** ..... **06-01**
- (52) **U.S. Cl.**  
USPC ..... **D6/716.1**
- (58) **Field of Classification Search**  
USPC ..... D6/335-338, 357, 369, 702, 716, 716.1,  
D6/712, 708, 708.16, 708.17; 297/135,  
297/157.1, 158.2, 158.3, 158.5, 174 R, 245  
See application file for complete search history.

(56) **References Cited**

**U.S. PATENT DOCUMENTS**

D313,128 S	12/1990	Serafini	
D365,937 S *	1/1996	Skalka	D6/370
D381,820 S *	8/1997	Kovalchek	D6/337
D396,358 S *	7/1998	Geier	D6/349
D413,734 S	9/1999	Bue	
D432,797 S *	10/2000	Schilling et al.	D6/337
D448,938 S	10/2001	Ng et al.	
D453,424 S *	2/2002	Stewart	D6/349
D454,436 S *	3/2002	Shilling et al.	D6/337
D457,738 S *	5/2002	Slear et al.	D6/355
D478,732 S *	8/2003	Pajerski et al.	D6/337
D479,406 S	9/2003	Pajerski et al.	

D479,773 S	9/2003	Pajerski et al.	
D522,775 S *	6/2006	Skalka	D6/495
D523,650 S *	6/2006	Skalka	D6/349
D526,805 S *	8/2006	Skalka	D6/381
D536,184 S *	2/2007	Skalka	D6/349
7,252,331 B1 *	8/2007	Walton	297/232

(Continued)

**OTHER PUBLICATIONS**

Victor Stanley, Inc. Steelsites(198 ) Series RND-363 Table (2010).

(Continued)

*Primary Examiner* — Sandra Snapp

(74) *Attorney, Agent, or Firm* — Westerman, Hattori, Daniels & Adrian, LLP

(57) **CLAIM**

The ornamental design for a modular seat component, as shown and described.

**DESCRIPTION**

FIG. 1 is an isometric view of a modular seat component showing my new design.

FIG. 2 is a front elevational view of the modular seat component of FIG. 1.

FIG. 3 is a right side elevational view of the modular seat component of FIG. 1, the left side elevational view being a mirror image thereof.

FIG. 4 is a rear elevational view of the modular seat component of FIG. 1.

FIG. 5 is a top plan view of the modular seat component of FIG. 1; and,

FIG. 6 is a bottom plan view of the modular seat component of FIG. 1.

The broken line showing of brackets in FIGS. 1-29 is included for the purpose of illustrating use and environment and forms no part of the claimed design.

**1 Claim, 1 Drawing Sheet**

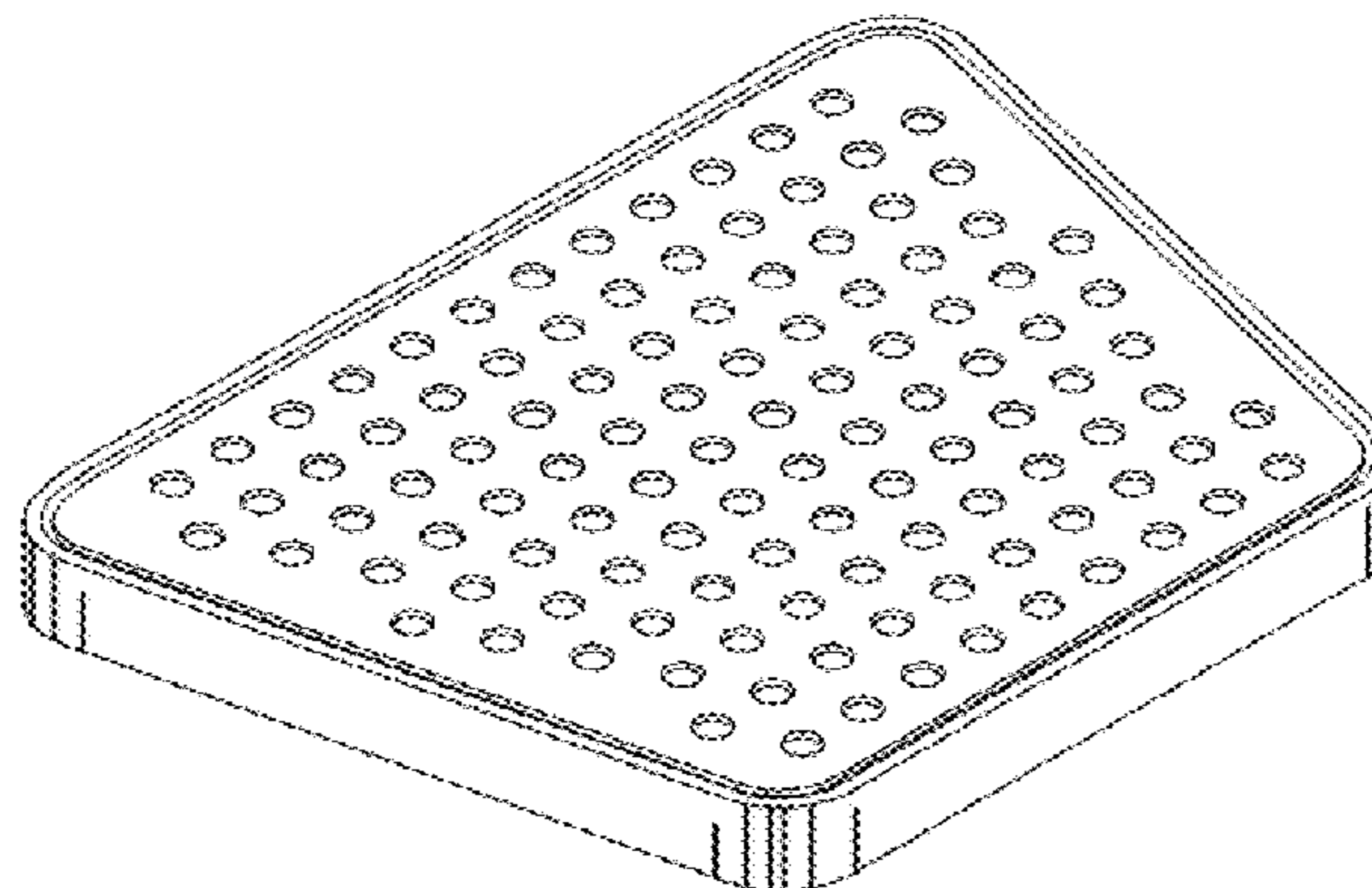

(56)

**References Cited**

**OTHER PUBLICATIONS**

U.S. PATENT DOCUMENTS

D595,973 S \* 7/2009 Skalka ..... D6/381  
D599,570 S \* 9/2009 Skalka ..... D6/355  
D604,520 S 11/2009 Wegman  
D604,521 S 11/2009 Wegman  
D604,522 S 11/2009 Wegman  
D604,523 S 11/2009 Wegman  
D621,629 S 8/2010 Weimer et al.  
D630,536 S \* 1/2011 Pettit ..... D10/96

Victor Stanley, Inc. Steelsites™ Series CRPR-4 Table (2010).  
Victor Stanley, Inc. Steelsites™ Series Benches and Seating Brochure (2010).  
Victor Stanley, Inc. Streetsites™ Series Brochure (2010).  
\* cited by examiner

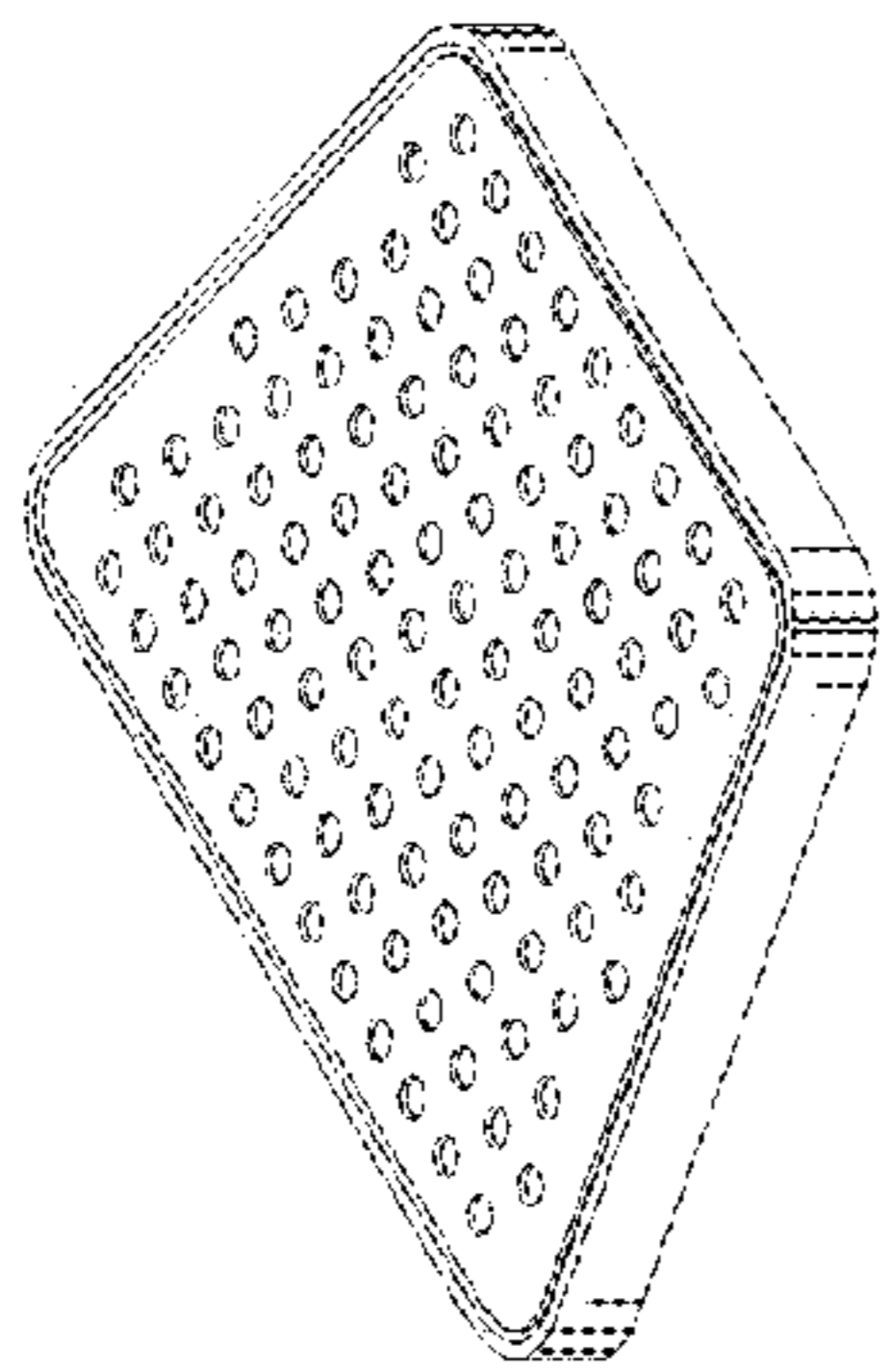

FIG. 1

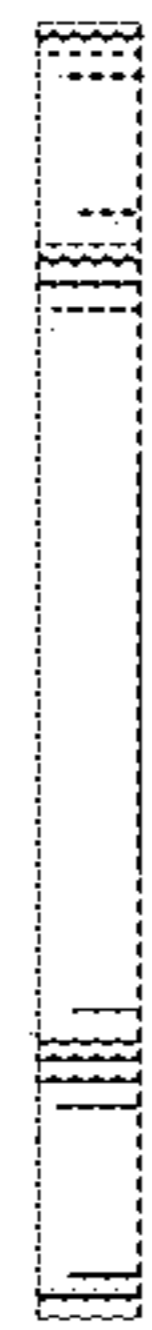

FIG. 2

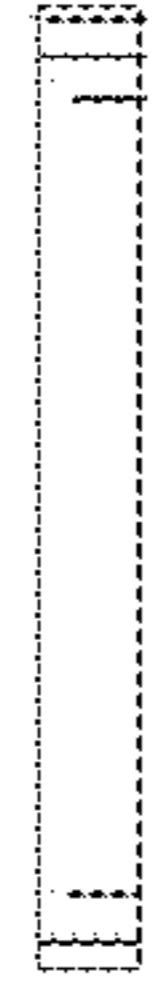

FIG. 3

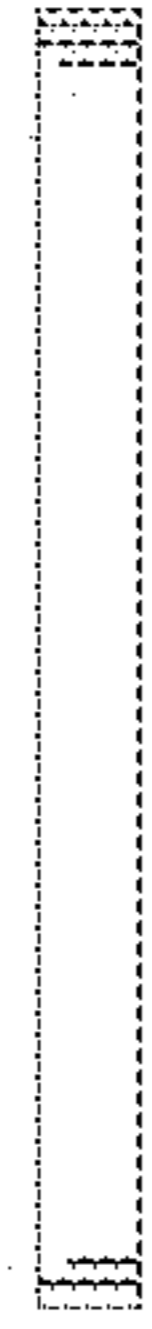

FIG. 4

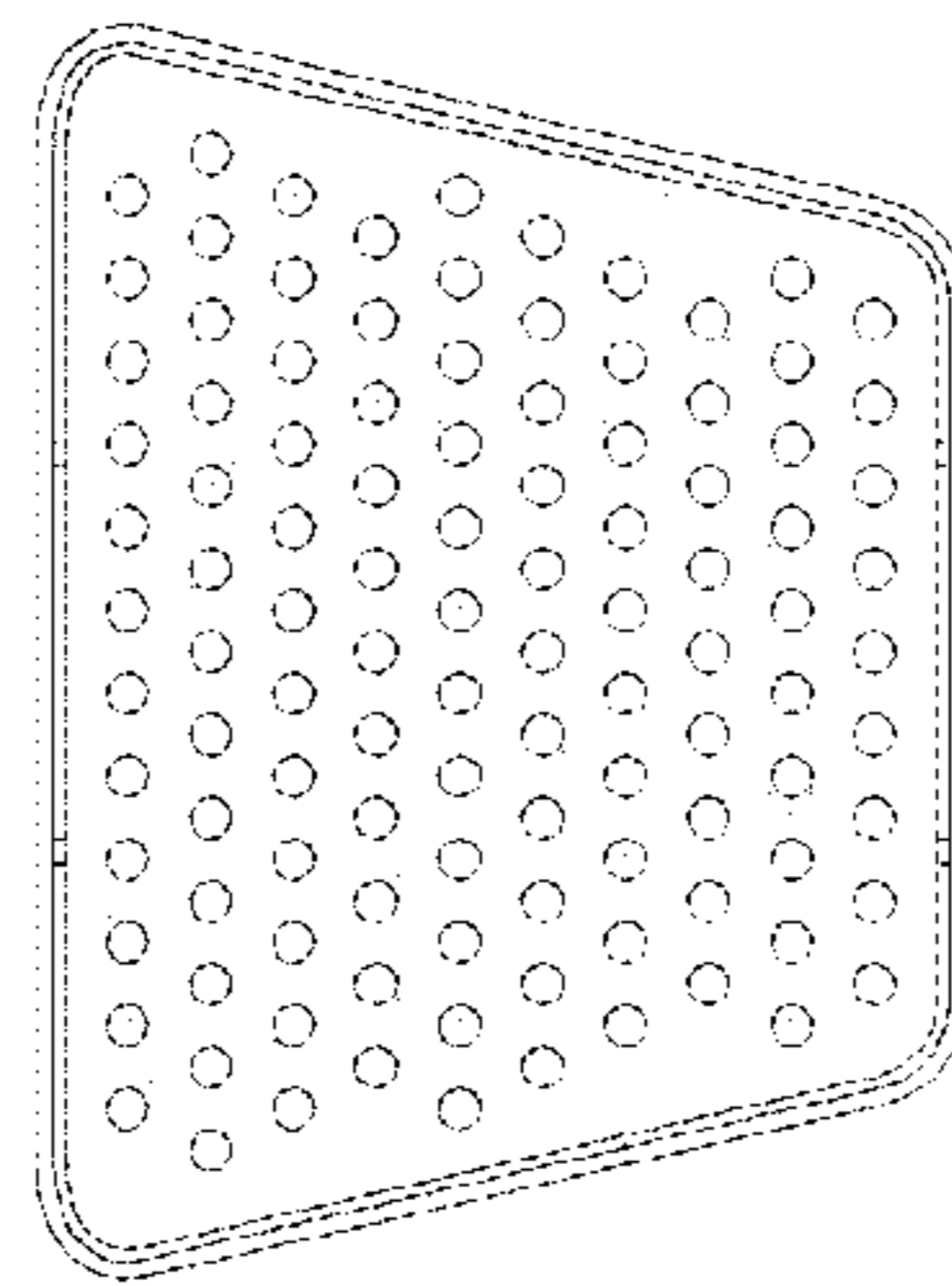

FIG. 5

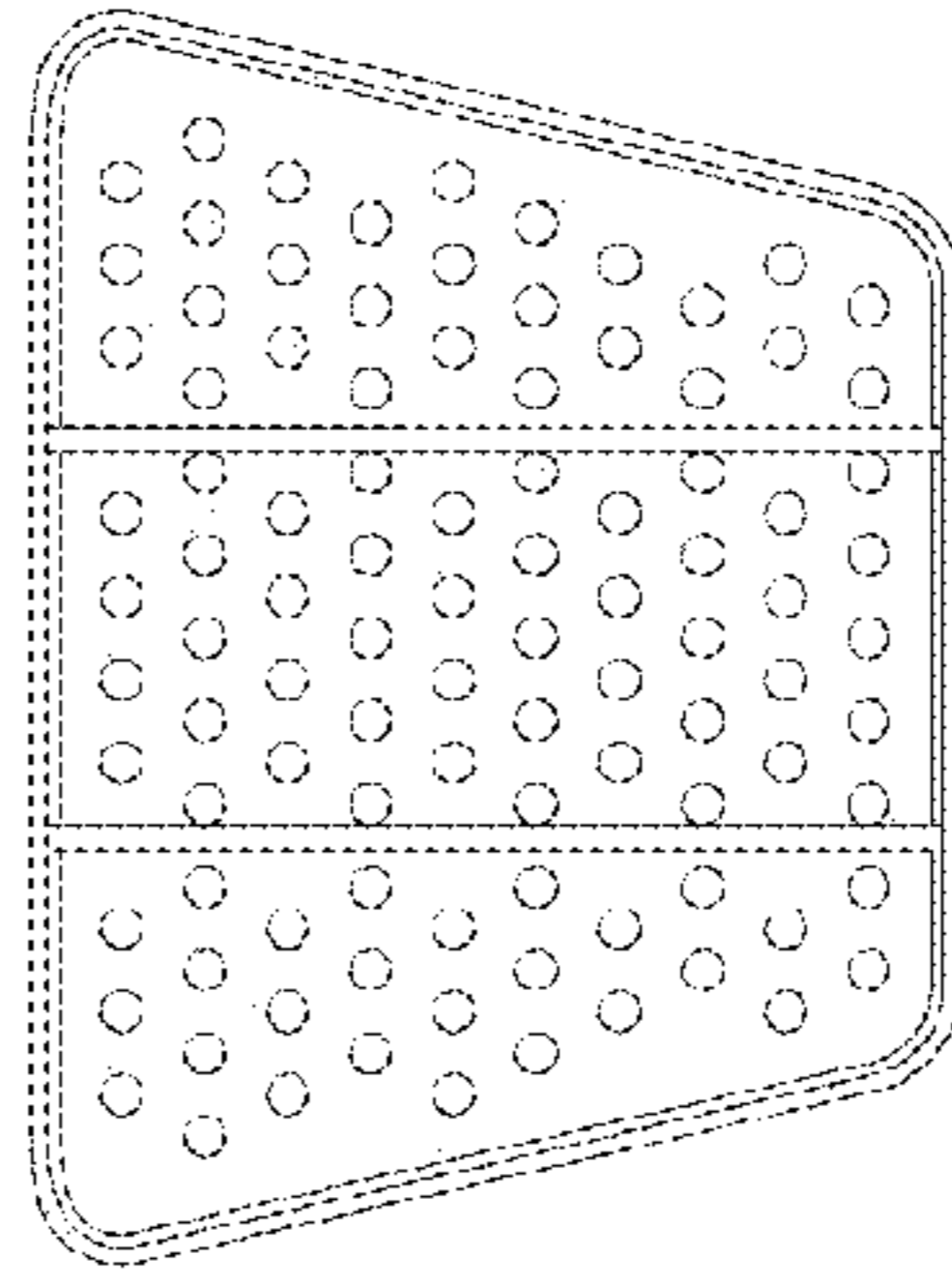

FIG. 6