



US00D696836S

(12) **United States Design Patent**
Chen

(10) **Patent No.:** **US D696,836 S**

(45) **Date of Patent:** **** Jan. 7, 2014**

(54) **DOG CHEW**

(75) Inventor: **Zuxi Chen**, Wenzhou (CN)

(73) Assignee: **Wenzhou Yuxiang Pet Product Co., Ltd.**, Shuitou Town Pingyang County Zhejiang P (CN)

(**) Term: **14 Years**

(21) Appl. No.: **29/393,780**

(22) Filed: **Jun. 9, 2011**

(51) **LOC (10) Cl.** **01-01**

(52) **U.S. Cl.**

USPC **D1/106**

(58) **Field of Classification Search**

USPC D1/100–130, 199; 426/5, 76, 87, 92, 426/94, 95, 99, 101, 103, 104, 108, 426/138–139, 143, 144, 279, 282, 283, 391, 426/514, 549, 559, 560, 660, 808; D21/385, 386; D30/160; D11/90, 157; 40/310; 119/710; 2/60, 98, 116, 2/123–124, 127, 129, 136, 141.1, 155; 249/117, 137

See application file for complete search history.

(56) **References Cited**

U.S. PATENT DOCUMENTS

D427,416	S	*	7/2000	Frudakis	D1/199
6,178,922	B1	*	1/2001	Denesuk et al.	119/710
D472,682	S	*	4/2003	Tepper et al.	D30/160
D477,693	S	*	7/2003	Kirch	D30/160
D477,695	S	*	7/2003	Kirch	D30/160
D479,369	S	*	9/2003	Kirch	D30/160
D495,467	S	*	9/2004	Tepper et al.	D1/199
D497,240	S	*	10/2004	Tepper et al.	D1/199
6,840,196	B2	*	1/2005	Kirch	119/710
7,194,981	B2	*	3/2007	Kirch et al.	119/710
D608,060	S	*	1/2010	Stamos et al.	D30/160
7,691,426	B2	*	4/2010	Axelrod et al.	426/132

D632,212	S	*	2/2011	DiStefano	D11/157
8,074,609	B2	*	12/2011	Adkins	119/710
D658,348	S	*	5/2012	McCleary	D1/199
2005/0271775	A1	*	12/2005	Kirch et al.	426/104
2009/0004338	A1	*	1/2009	Anderson et al.	426/92
2011/0262587	A1	*	10/2011	Stern et al.	426/5
2012/0079992	A1	*	4/2012	Chen et al.	119/710
2012/0082762	A1	*	4/2012	Weinberg et al.	426/92
2012/0085296	A1	*	4/2012	Stern	119/710
2012/0186535	A1	*	7/2012	Tu	119/710
2013/0047931	A1	*	2/2013	Lai	119/710
2013/0047932	A1	*	2/2013	Salmon Hyder et al.	119/710
2013/0133588	A1	*	5/2013	Chen et al.	119/710

* cited by examiner

OTHER PUBLICATIONS

Dingo Mini Rawhide Chews Nov. 20, 2006. [online.] [retrieved on Jul. 11, 2013]. Retrieved from internet <URL: <http://www.petsmart.com/product/index.jsp?productId=2750713>>.*

Primary Examiner — Cathron Brooks

Assistant Examiner — Katie Mroczka

(74) *Attorney, Agent, or Firm* — Davidson, Davidson & Kappen, LLC

(57) **CLAIM**

The ornamental design for the dog chew, as shown and described.

DESCRIPTION

FIG. 1 is a perspective view of the dog chew; FIG. 2 is a first plan view of the dog chew; FIG. 3 is a second plan view of the dog chew; FIG. 4 is a first side view of the dog chew; FIG. 5 is a second side view of the dog chew; FIG. 6 is a third plan view of the dog chew; and, FIG. 7 is a fourth plan view of the dog chew. The smaller stippled shading and larger stippled shading shown in FIGS. 1 to 7 represent a contrasting appearance.

1 Claim, 5 Drawing Sheets

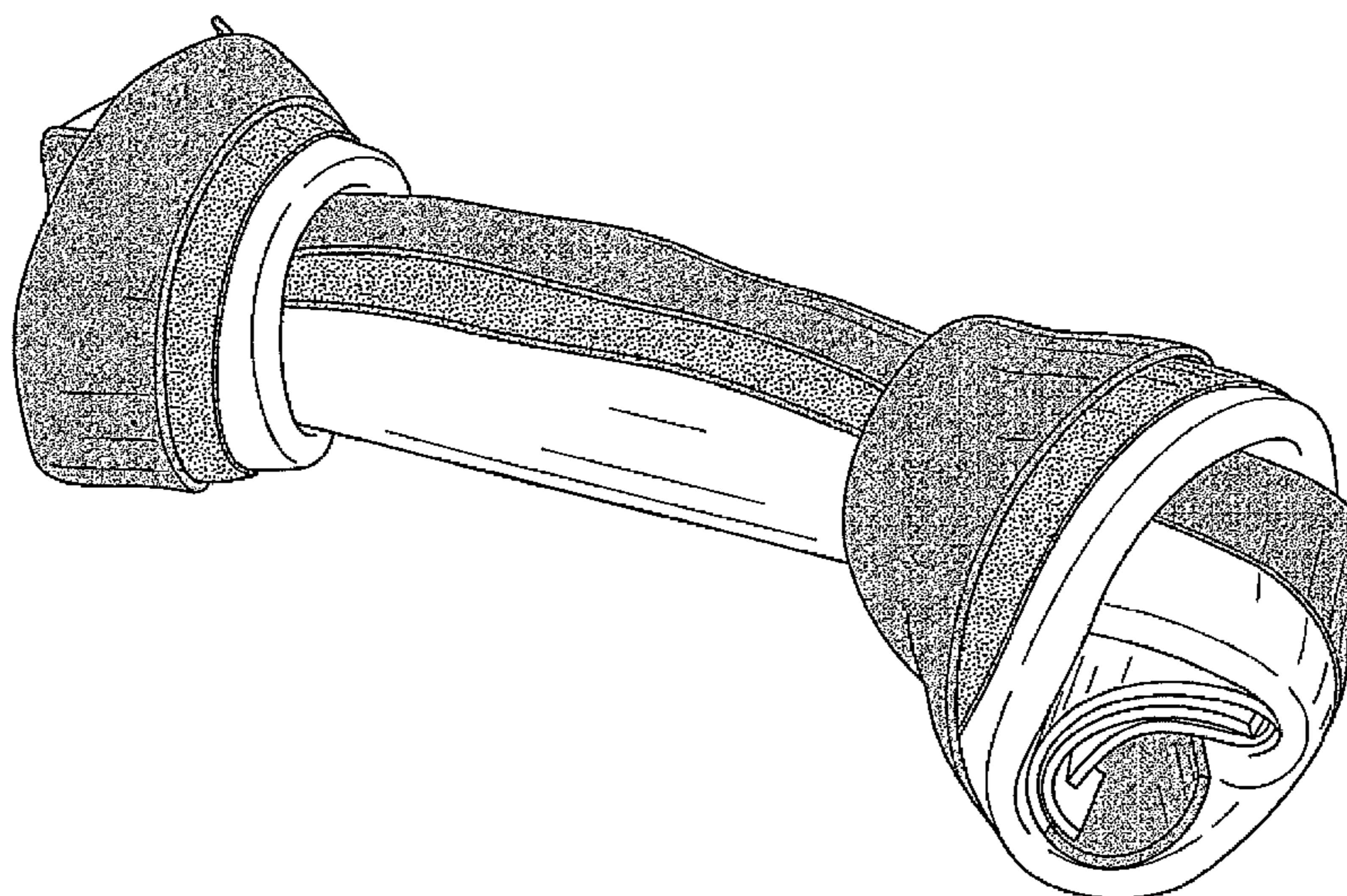

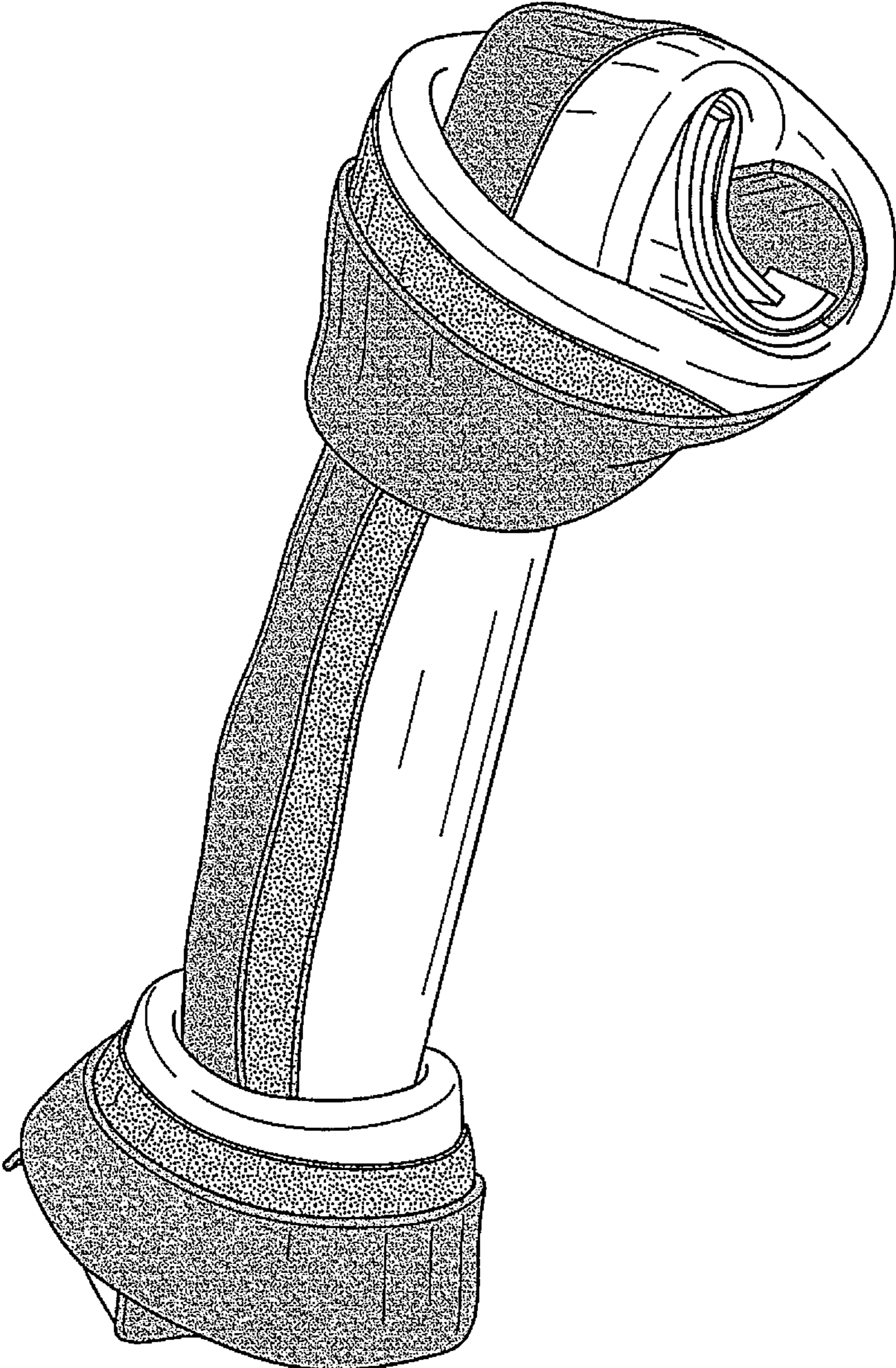

FIG. 1

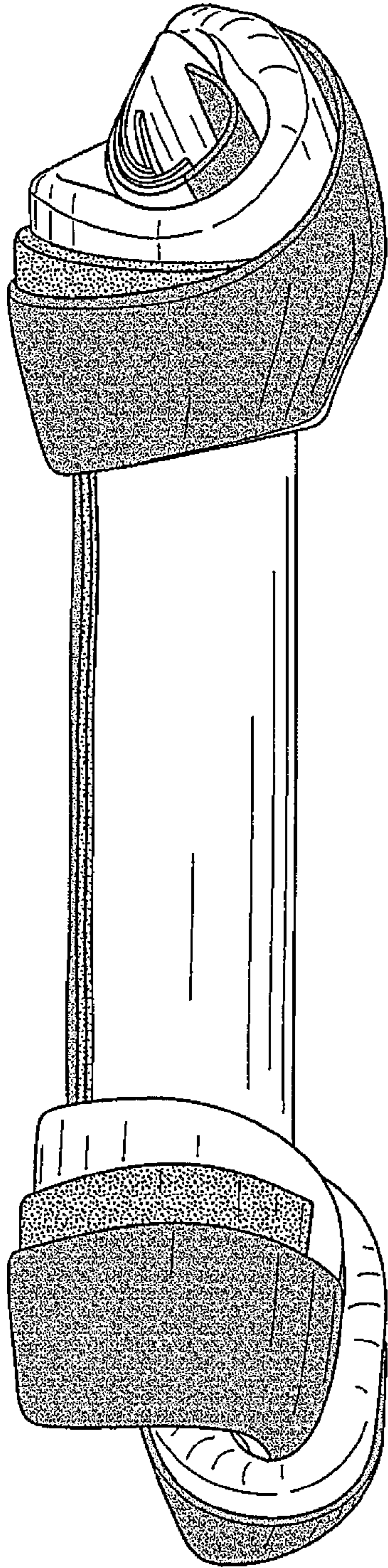

FIG. 2

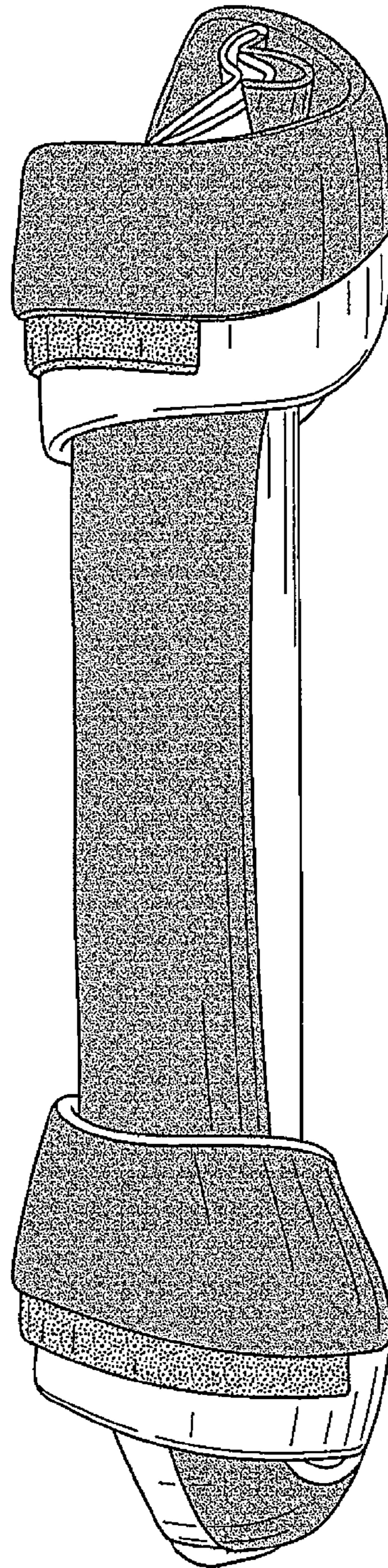

FIG. 3

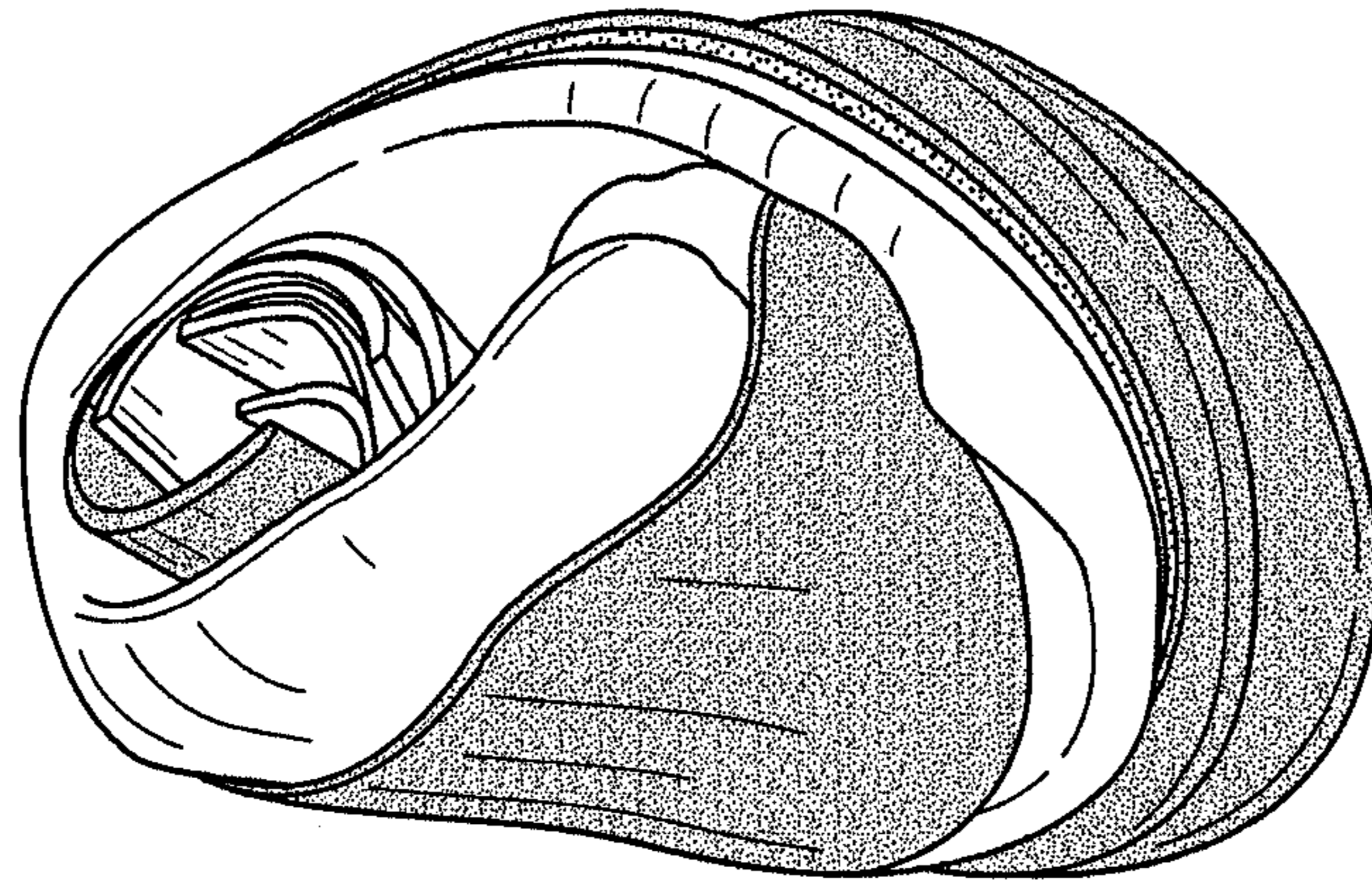

FIG. 4

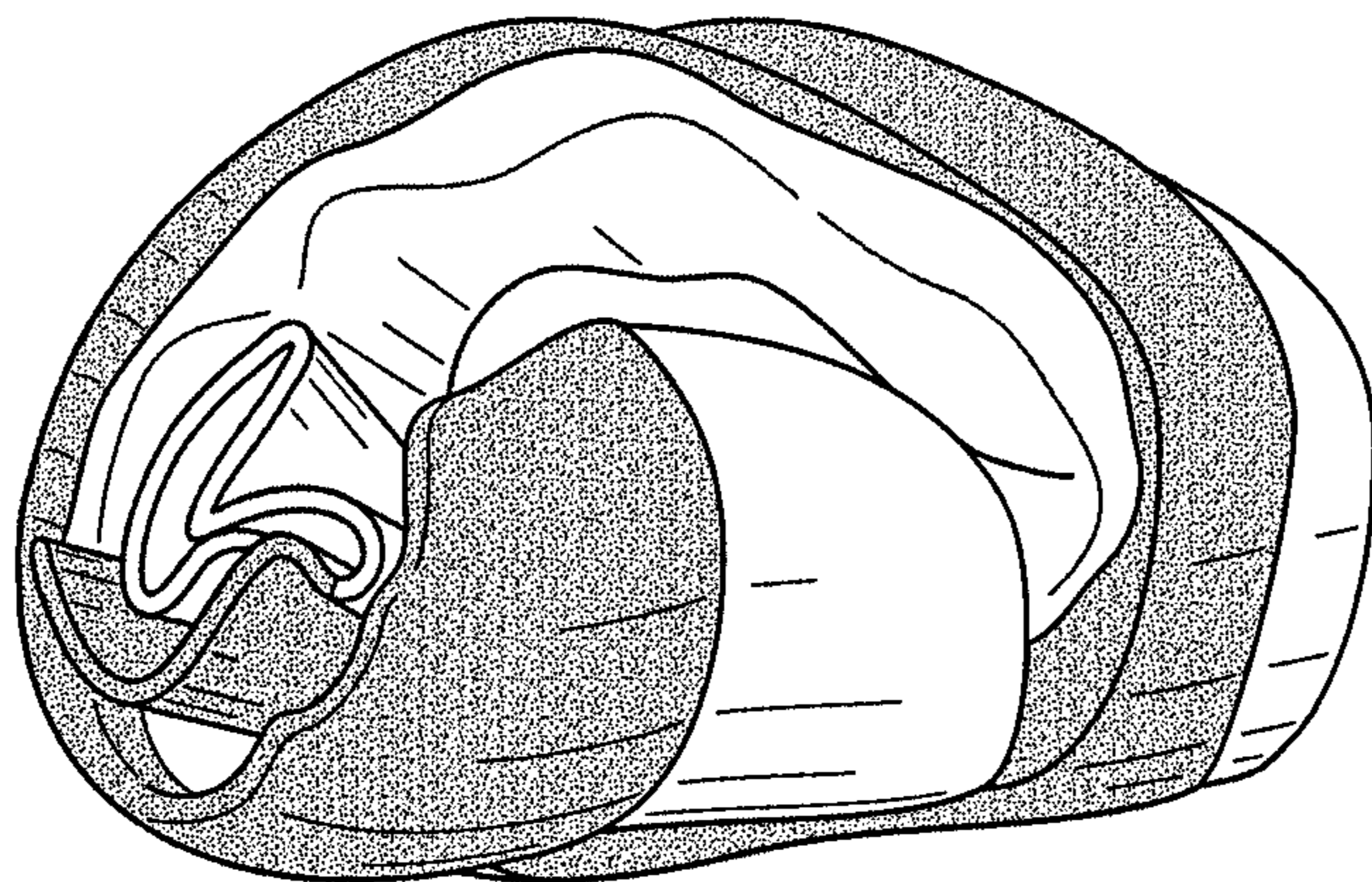

FIG. 5

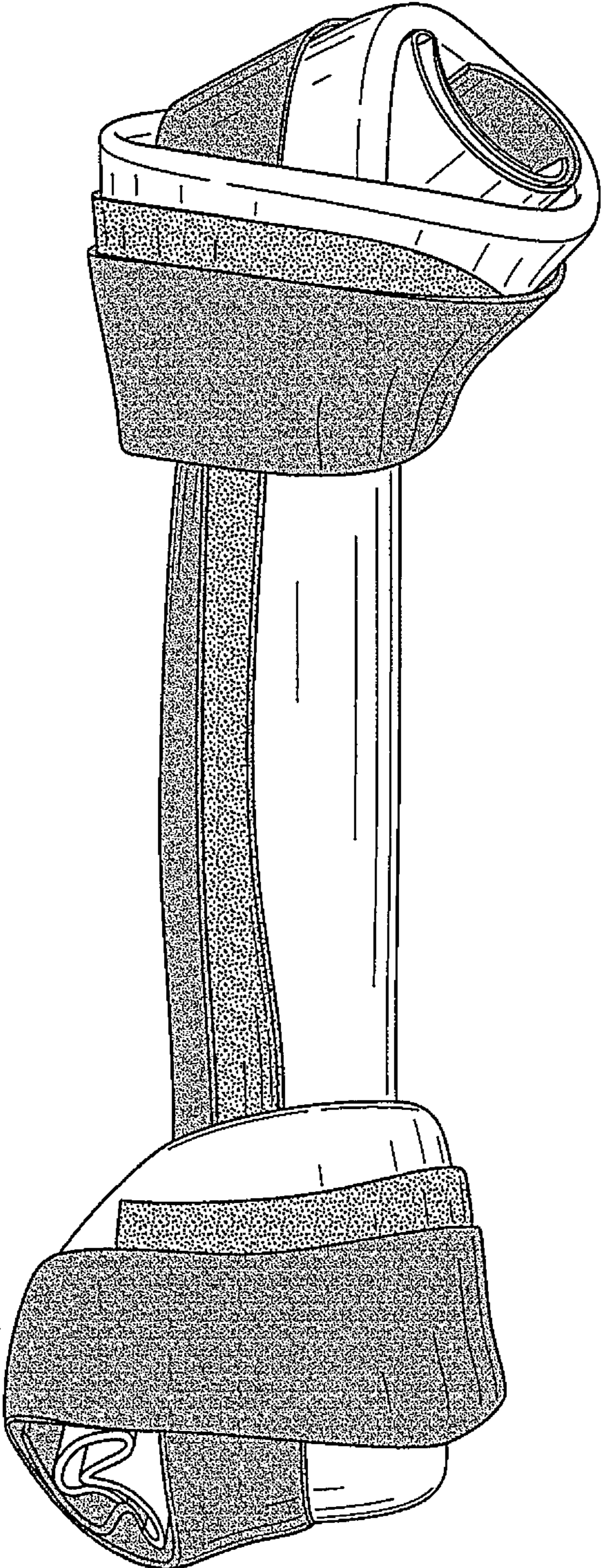

FIG. 6

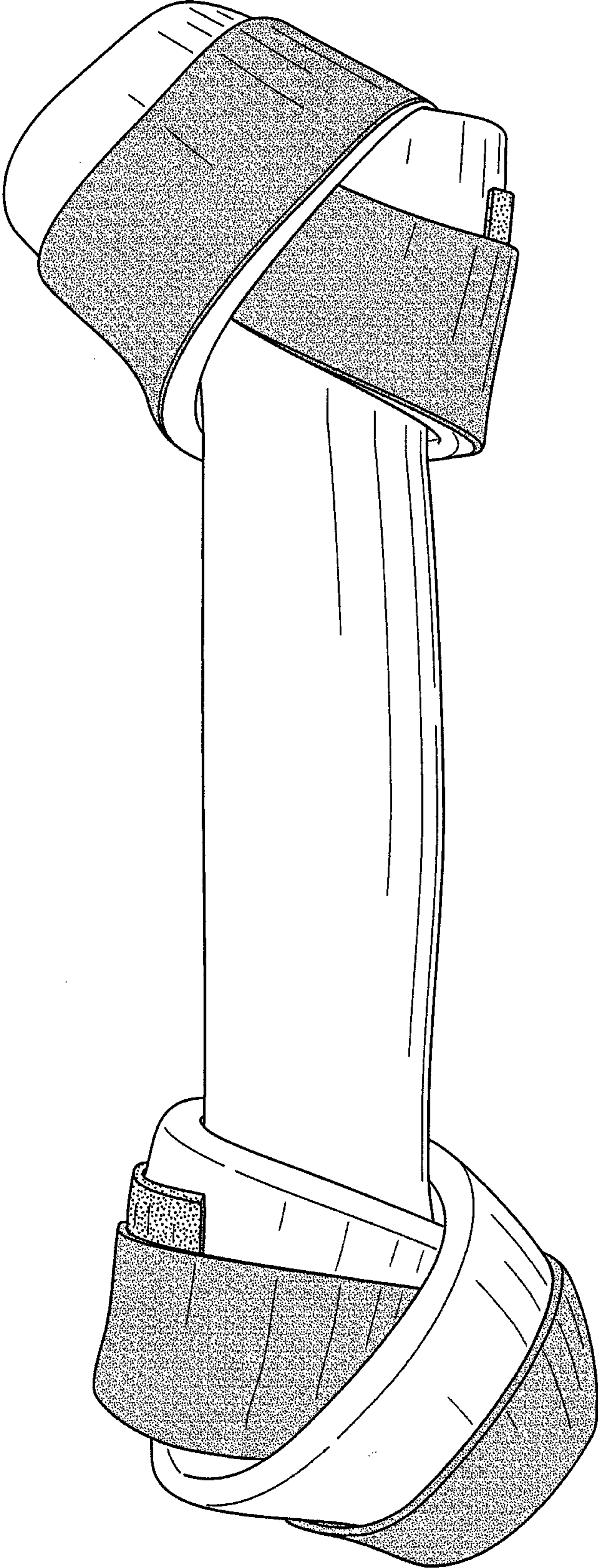

FIG. 7