



US00D696826S

(12) **United States Design Patent**
Seehoff et al.

(10) **Patent No.:** **US D696,826 S**

(45) **Date of Patent:** **** Dec. 31, 2013**

(54) **SCREEN CLEANER**

(75) Inventors: **Gary Stanley Seehoff**, Encino, CA
(US); **Huy Kha Nguyen**, Anaheim, CA
(US); **Jesse Clemmer**, Lake Forest, CA
(US)

(73) Assignee: **Evrholder Products, LLC**, Anaheim,
CA (US)

(**) Term: **14 Years**

(21) Appl. No.: **29/413,154**

(22) Filed: **Feb. 11, 2012**

(51) **LOC (9) Cl.** **08-99**

(52) **U.S. Cl.**
USPC **D32/35**; D4/138

(58) **Field of Classification Search**
USPC D32/35, 40, 41, 42, 45, 52; D8/83, 94,
D8/107, 300; D4/119, 122, 137, 138, 199;
15/104.002, 209.1, 105, 230.11, 214,
15/250.001, 250.003; 401/9, 123, 195,
401/196, 261, 266; 206/229; 134/6;
510/175; D7/693, 694, 695, 697
See application file for complete search history.

(56) **References Cited**

U.S. PATENT DOCUMENTS

2,811,733 A * 11/1957 Sloan 15/230.11
3,343,194 A * 9/1967 Ramelson 15/104.002
4,077,082 A * 3/1978 Roe et al. 15/230.11
D427,400 S * 6/2000 Stapleton et al. D32/35
D433,236 S * 11/2000 Katz et al. D4/124

D468,110 S * 1/2003 Libman et al. D4/138
D469,230 S * 1/2003 Libman et al. D32/41
6,687,945 B2 * 2/2004 Robinson 15/230.11
D609,537 S * 2/2010 Kestenbaum D7/695
D622,063 S * 8/2010 Isaac D4/122
7,827,651 B2 * 11/2010 Graham et al. 15/230.11
D637,403 S * 5/2011 Schmidt D4/122
D638,222 S * 5/2011 Molinet et al. D4/122
D677,469 S * 3/2013 Seehoff et al. D4/122
2006/0005333 A1 * 1/2006 Catalfamo et al. 15/104.002
2007/0017050 A1 * 1/2007 Lye 15/230.11
2007/0163062 A1 * 7/2007 McKay 15/104.002
2008/0040874 A1 * 2/2008 McKay 15/104.002

* cited by examiner

Primary Examiner — Caron D Veynar
Assistant Examiner — Martie K Holtje

(57) **CLAIM**

The ornamental design for a screen cleaner, as shown and described.

DESCRIPTION

FIG. 1 illustrates a top view of the claimed design for a screen cleaner;
FIG. 2 illustrates a left-side view thereof;
FIG. 3 illustrates a right-side view thereof;
FIG. 4 illustrates a bottom view thereof;
FIG. 5 illustrates a front view thereof;
FIG. 6 illustrates a rear view thereof; and,
FIG. 7 illustrates a perspective view thereof.
The broken line showing an exemplary roller is for illustrative purposes only and forms no part of the claimed design.

1 Claim, 7 Drawing Sheets

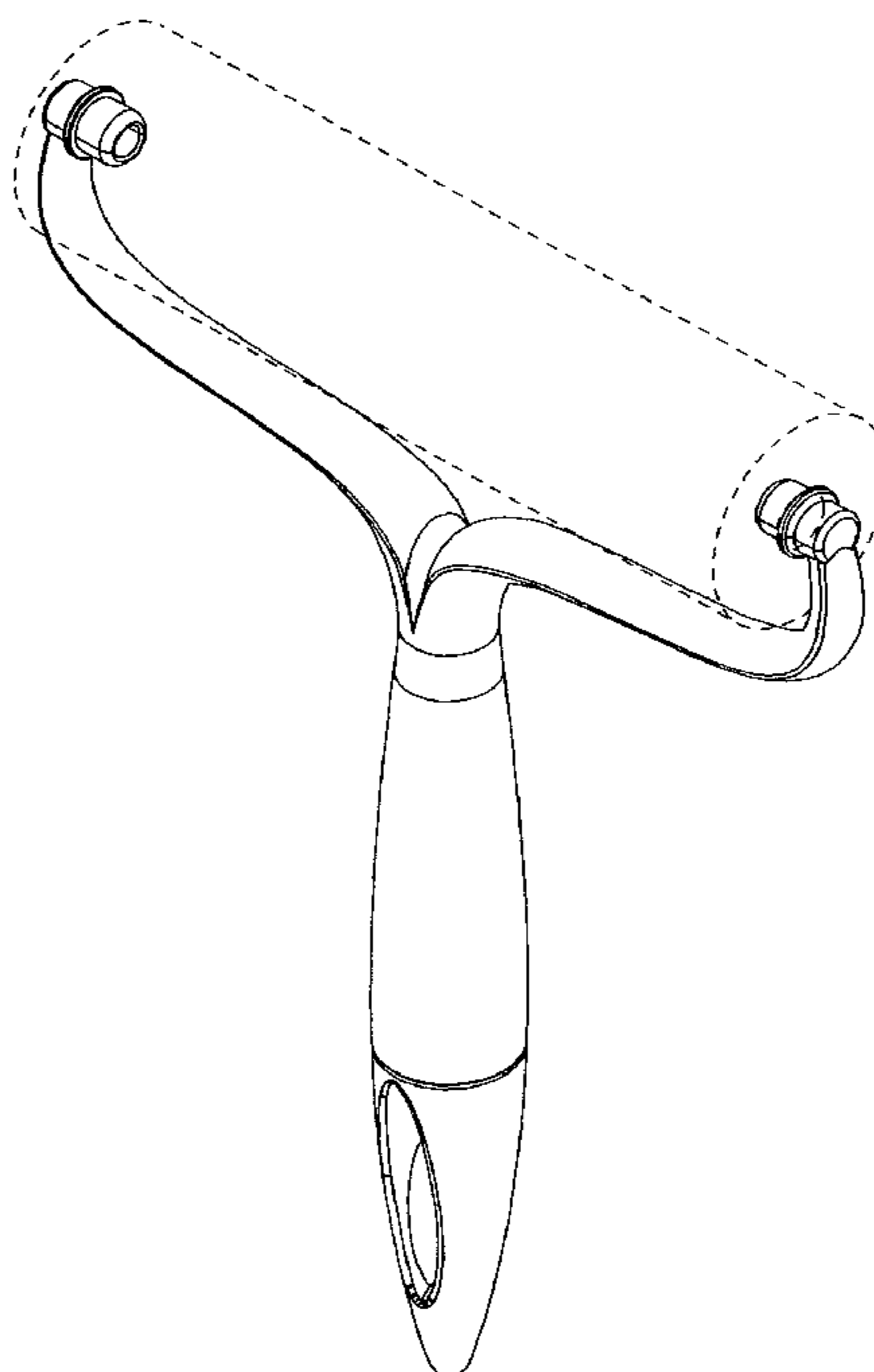

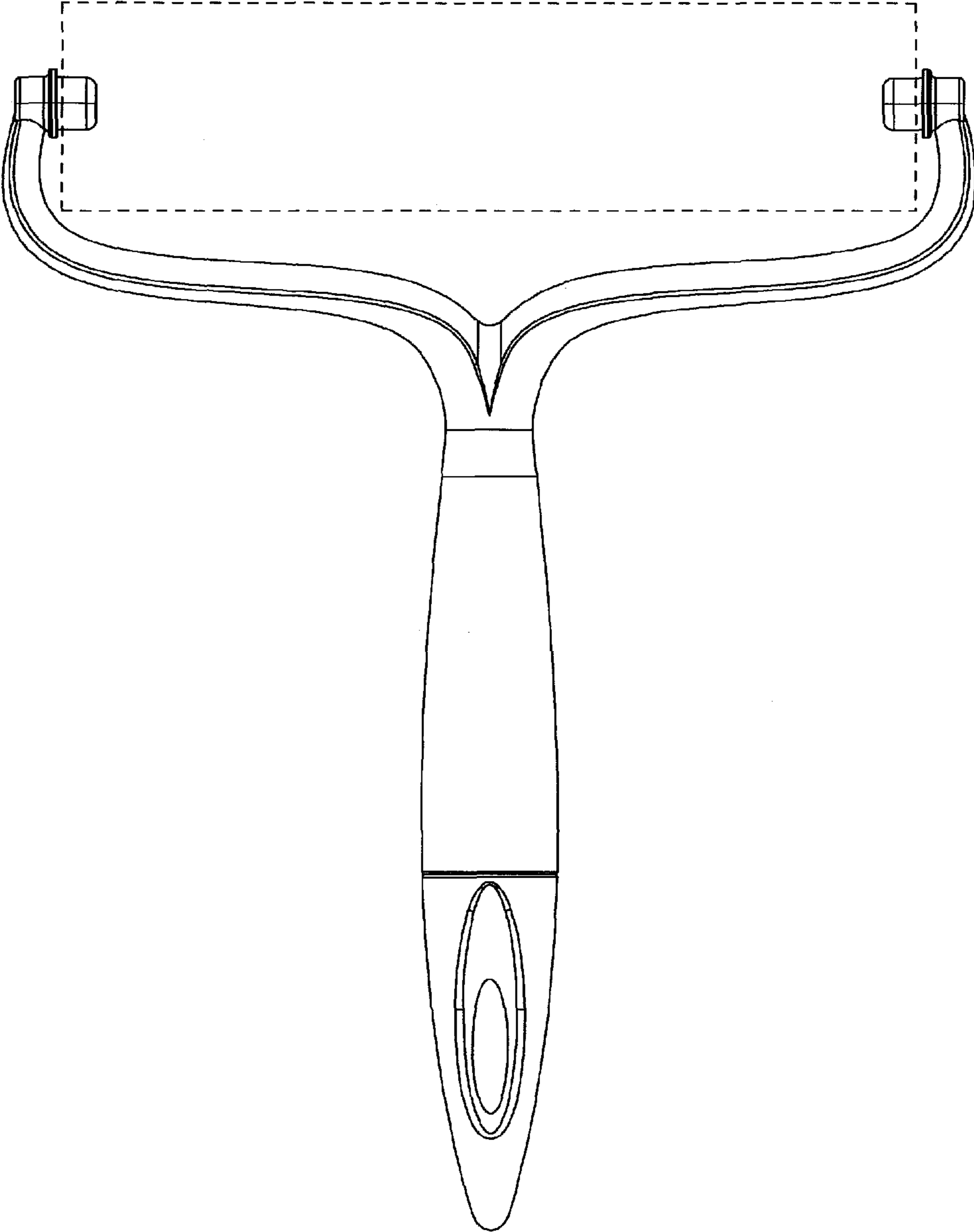

FIG 1

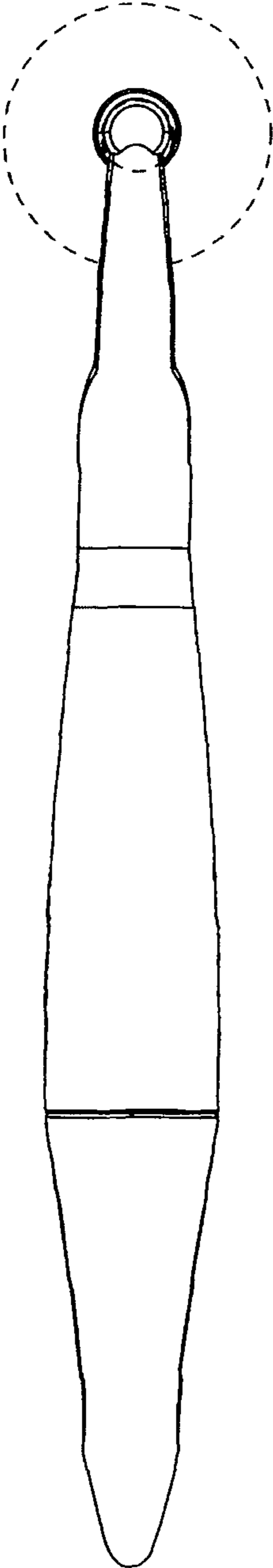

FIG 2

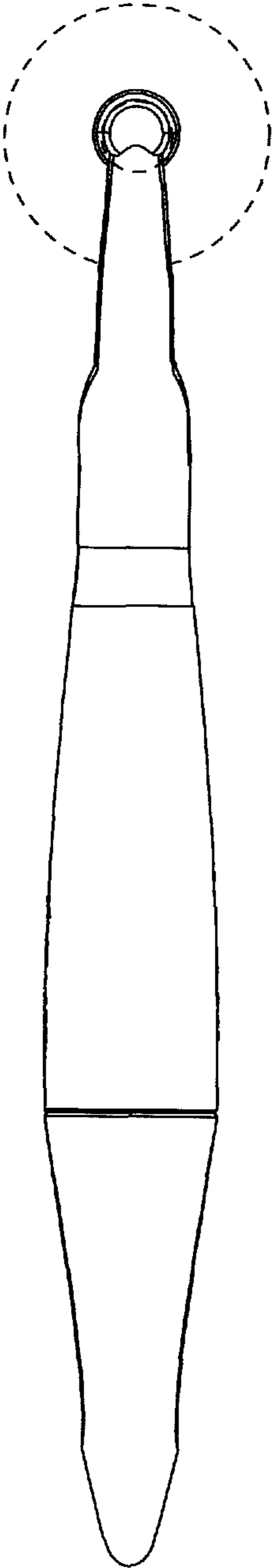

FIG 3

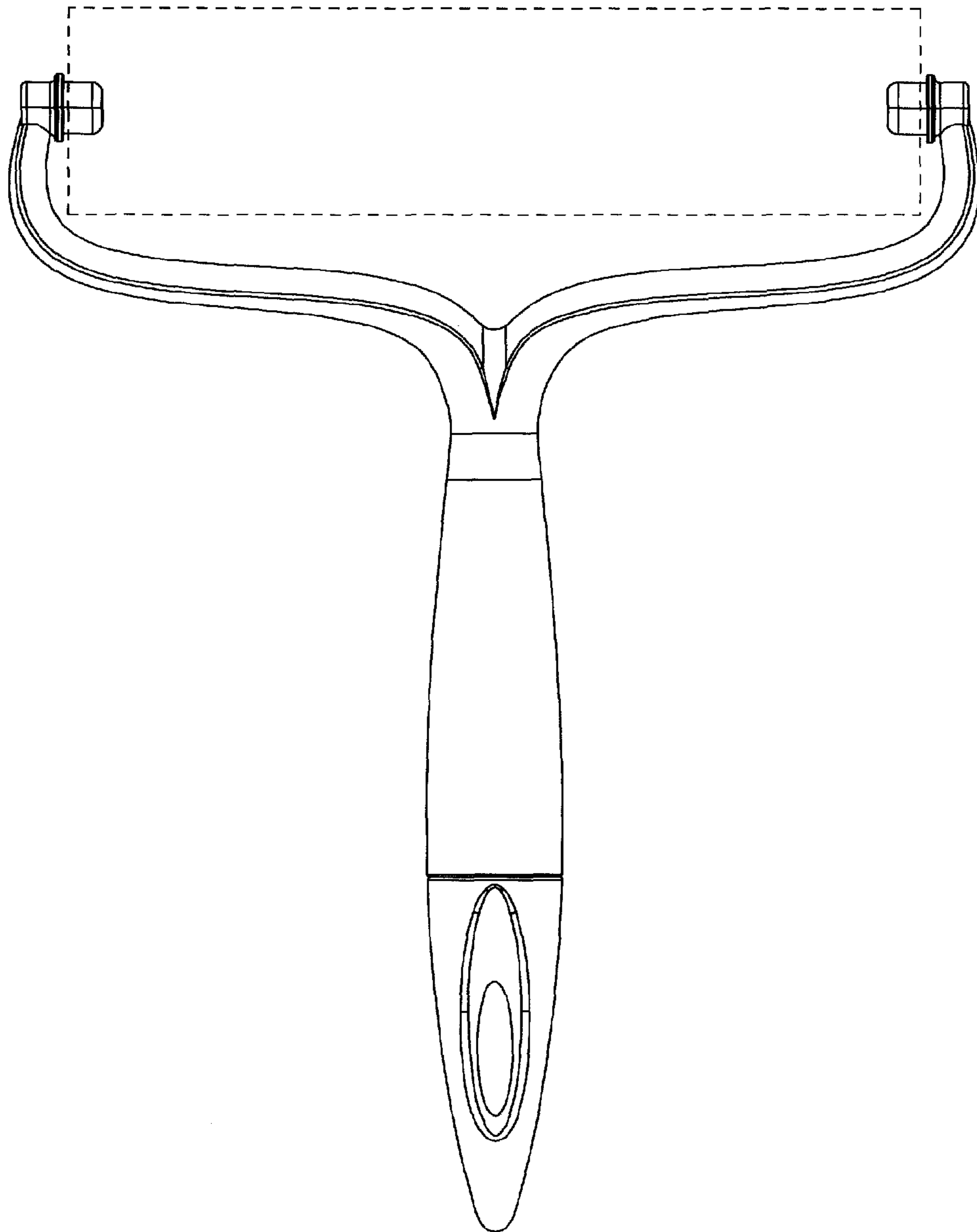

FIG 4

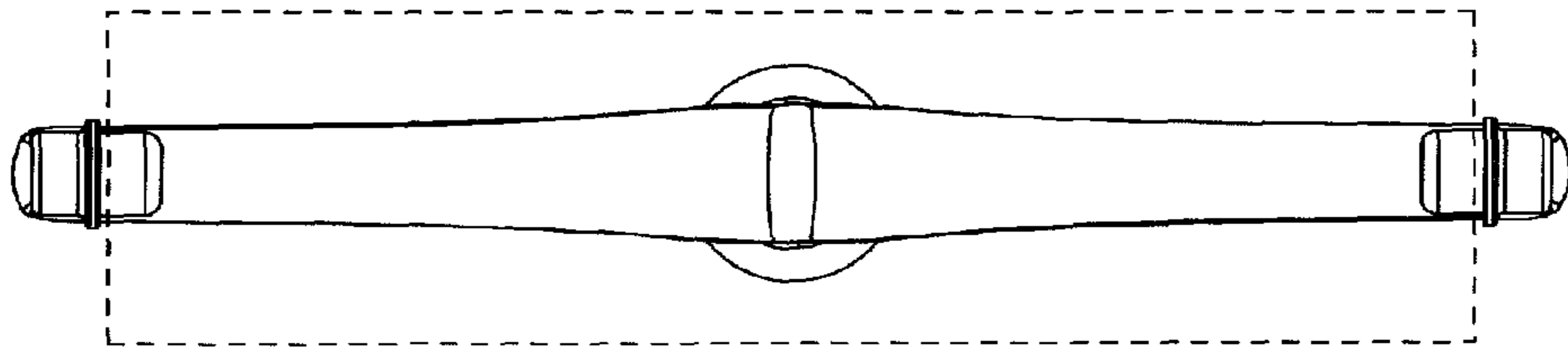

FIG 5

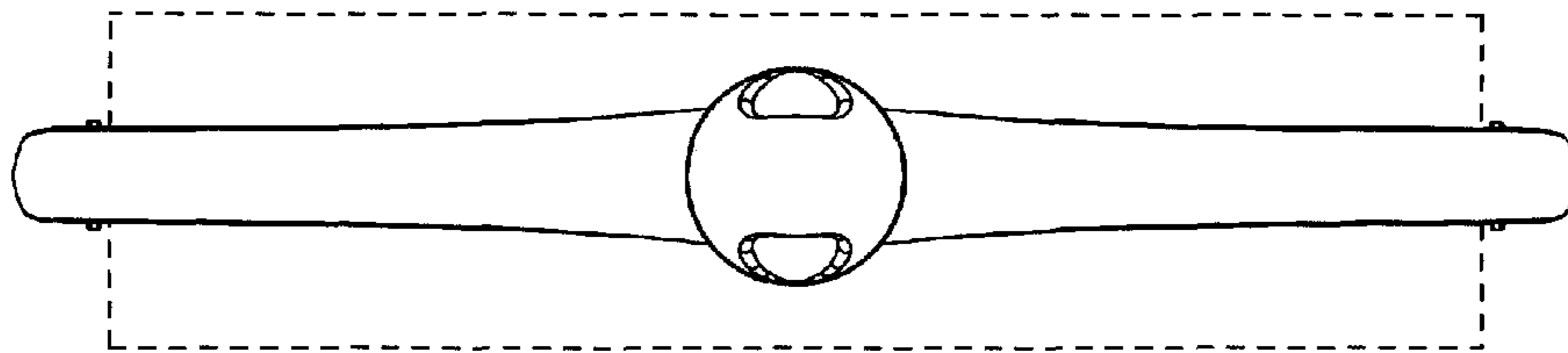

FIG 6

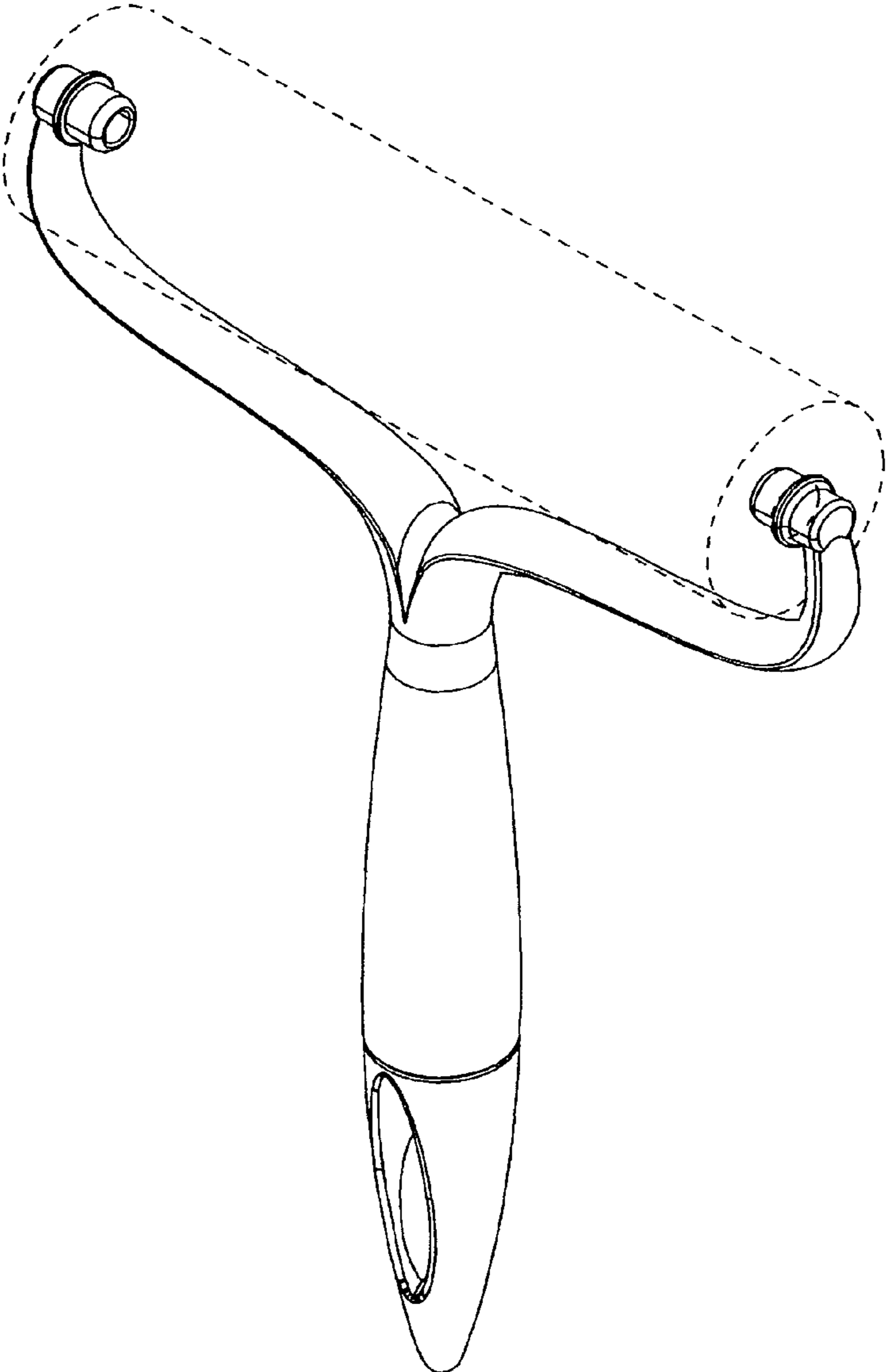

FIG 7