



US00D696728S

(12) **United States Design Patent**  
**Schwartz**

(10) **Patent No.:** **US D696,728 S**

(45) **Date of Patent:** **\*\* Dec. 31, 2013**

(54) **GAME FOR TEACHING MATH SKILLS**

D483,417 S \* 12/2003 Michalek ..... D21/372  
D517,612 S \* 3/2006 Bowling ..... D21/373  
D597,610 S \* 8/2009 Denoual ..... D21/372

(76) Inventor: **Jonathan Schwartz**, Colfax, CA (US)

\* cited by examiner

(\*\*) Term: **14 Years**

*Primary Examiner* — Sandra Morris

(21) Appl. No.: **29/430,008**

(74) *Attorney, Agent, or Firm* — Larry D. Johnson

(22) Filed: **Aug. 20, 2012**

(51) **LOC (9) Cl.** ..... **21-01**

(52) **U.S. Cl.**

USPC ..... **D21/372**; D19/62

(58) **Field of Classification Search**

USPC ..... D19/60–62; D21/369, 372–373;  
273/138.1, 146, 268, 274;  
434/128–129, 196, 202

See application file for complete search history.

(57) **CLAIM**

The ornamental design for a game for teaching math skills, as shown and described.

**DESCRIPTION**

FIG. 1 is a perspective view;  
FIG. 2 is a top plan view thereof;  
FIG. 3 is a bottom plan view thereof;  
FIG. 4 is a bottom end view thereof;  
FIG. 5 is a top end view thereof;  
FIG. 6 is a left end view thereof;  
FIG. 7 is a right end view thereof;  
FIG. 8 is a perspective view of an alternate embodiment;  
FIG. 9 is a top plan view thereof;  
FIG. 10 is a bottom plan view thereof;  
FIG. 11 is a bottom end view thereof;  
FIG. 12 is a top end view thereof;  
FIG. 13 is a left end view thereof; and,  
FIG. 14 is a right end view thereof.

(56) **References Cited**

**U.S. PATENT DOCUMENTS**

356,167	A *	1/1887	Shannon	.....	434/196
2,253,605	A *	8/1941	Bloom	.....	273/268
2,494,469	A *	1/1950	Booth	.....	434/196
3,703,040	A *	11/1972	Hill	.....	434/202
3,747,934	A *	7/1973	Barrett	.....	273/268
4,410,182	A *	10/1983	Francis	.....	273/268
4,421,315	A *	12/1983	Cutler	.....	273/268
4,436,306	A *	3/1984	Sanders	.....	273/146
5,597,308	A *	1/1997	Woldenberg et al.	.....	434/196
D479,283	S *	9/2003	Heil	.....	D21/372

**1 Claim, 6 Drawing Sheets**

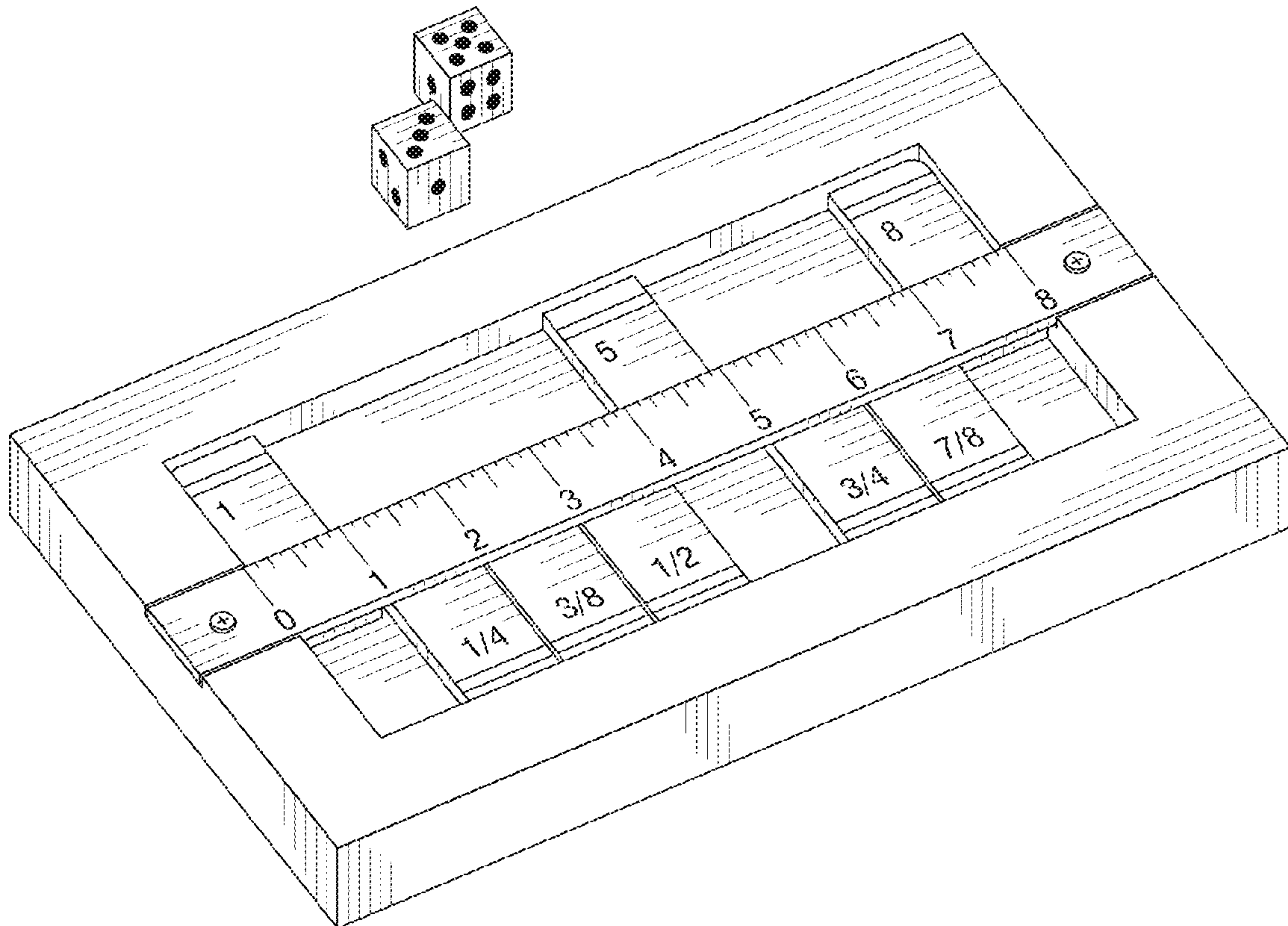

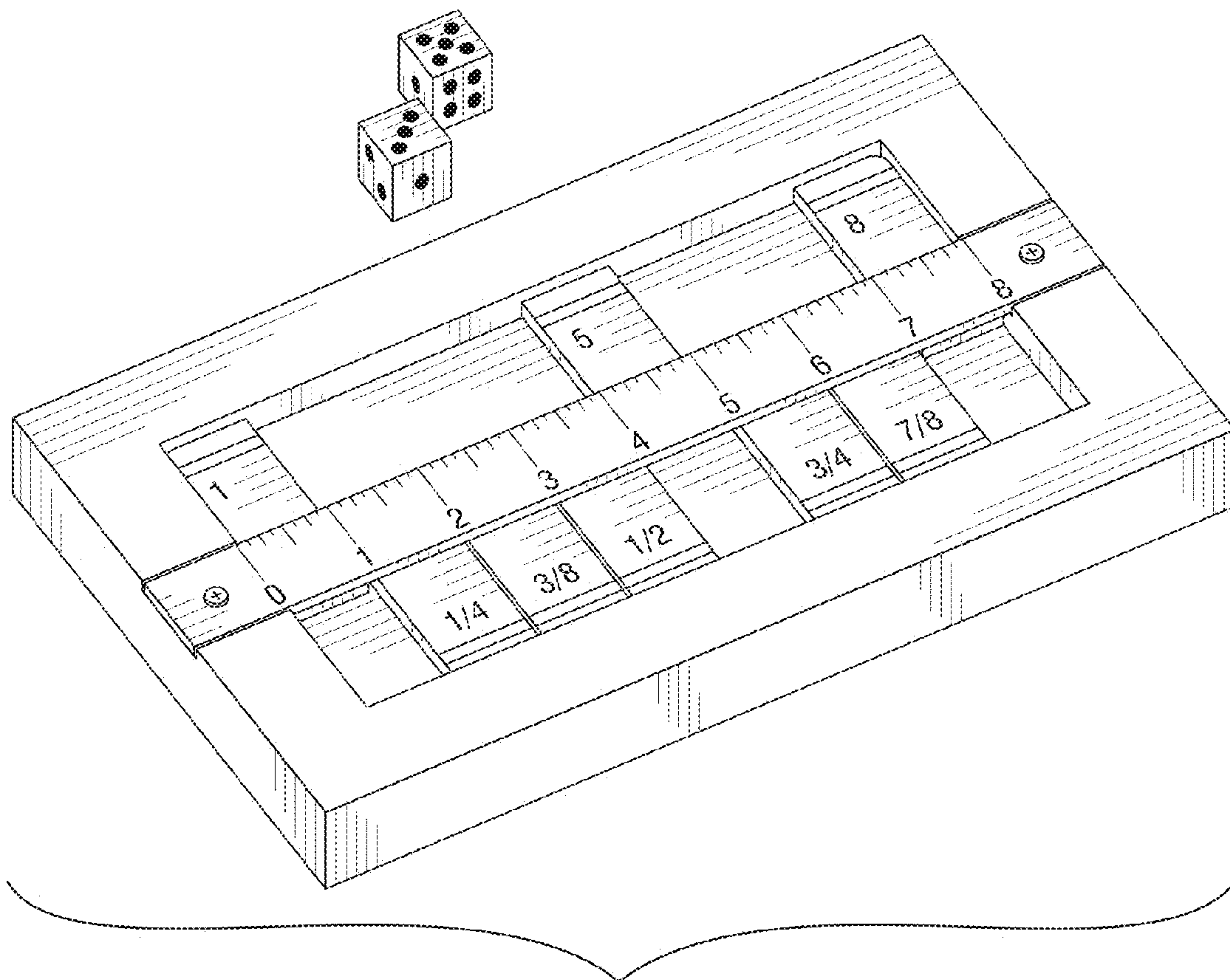
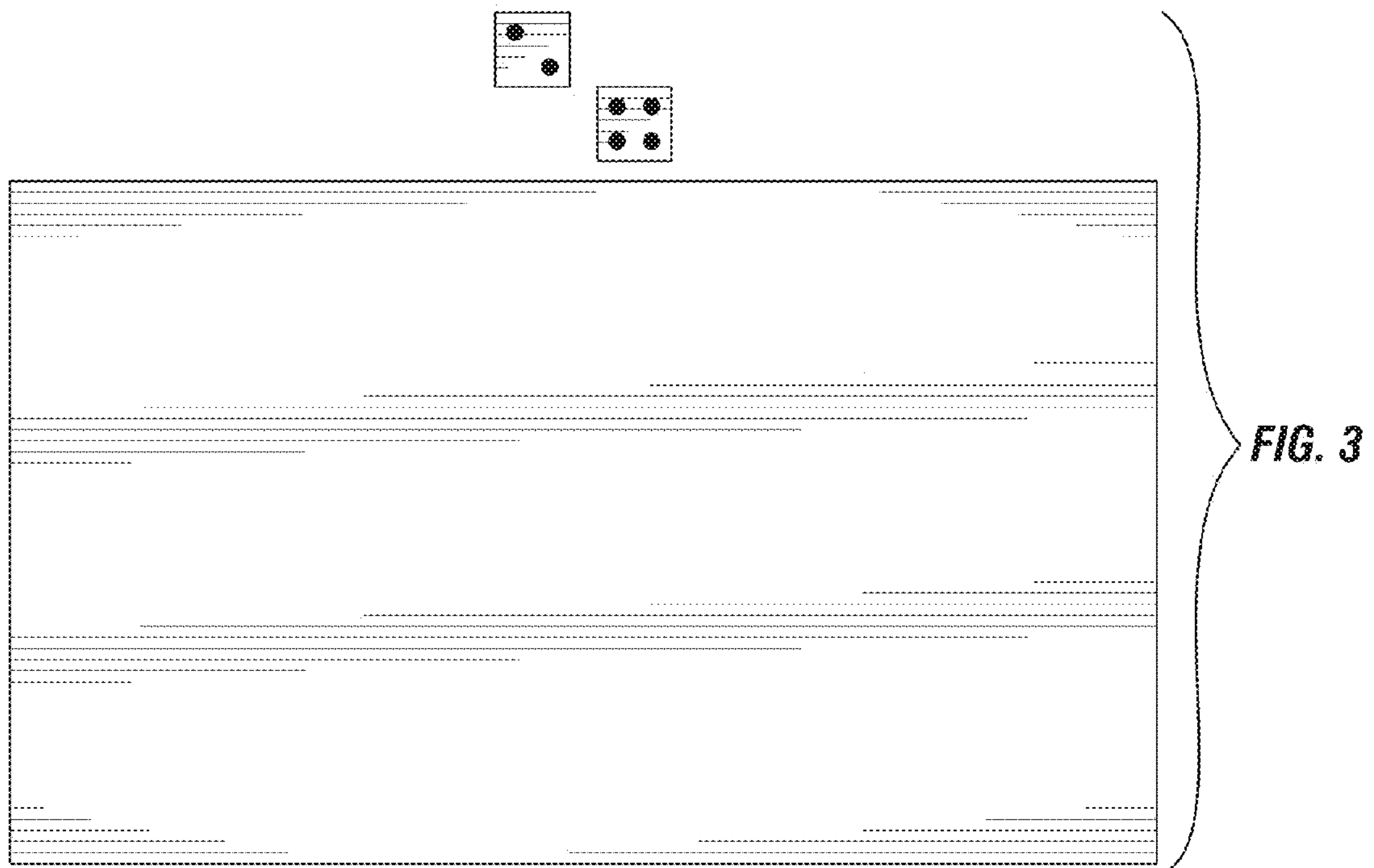
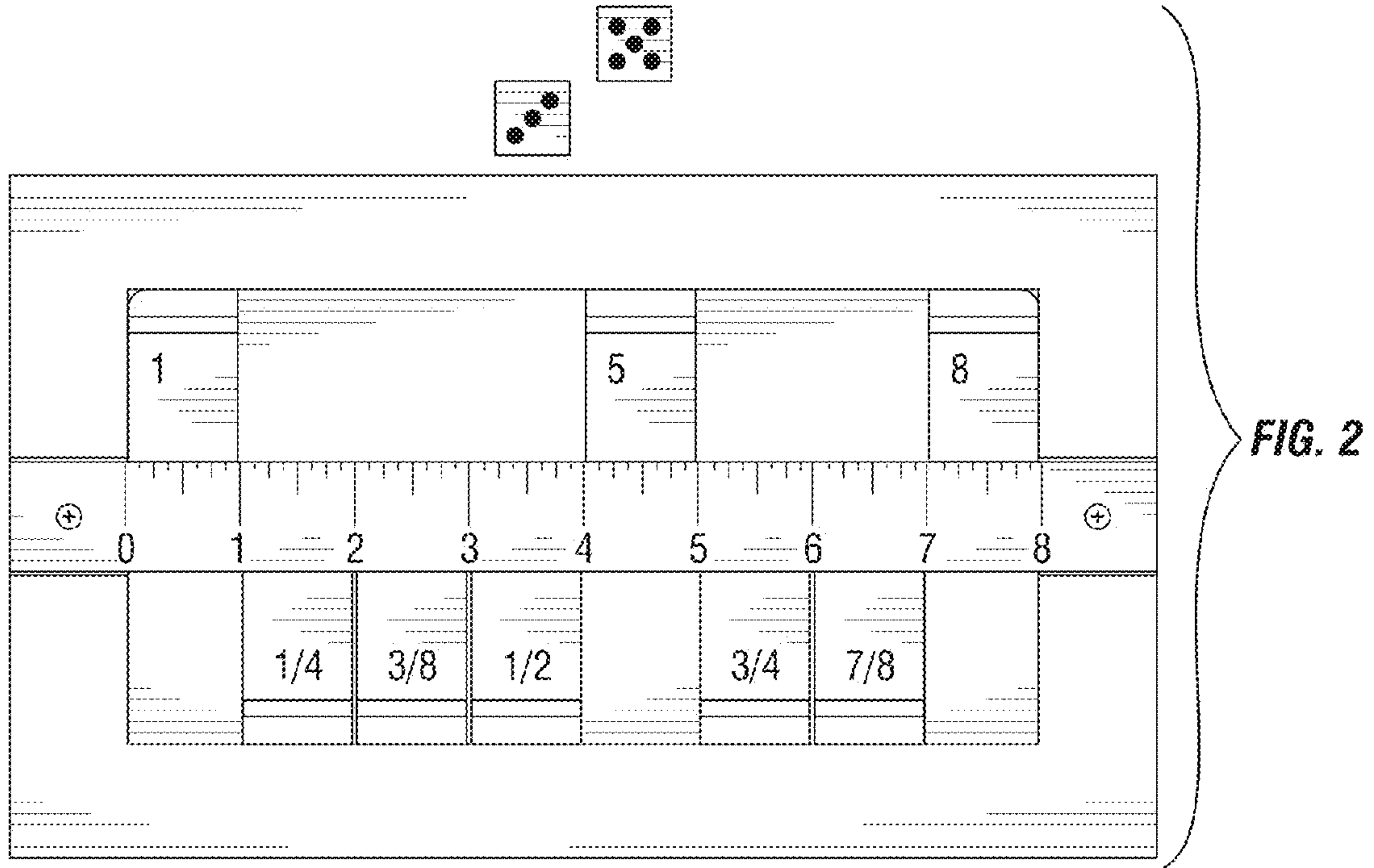
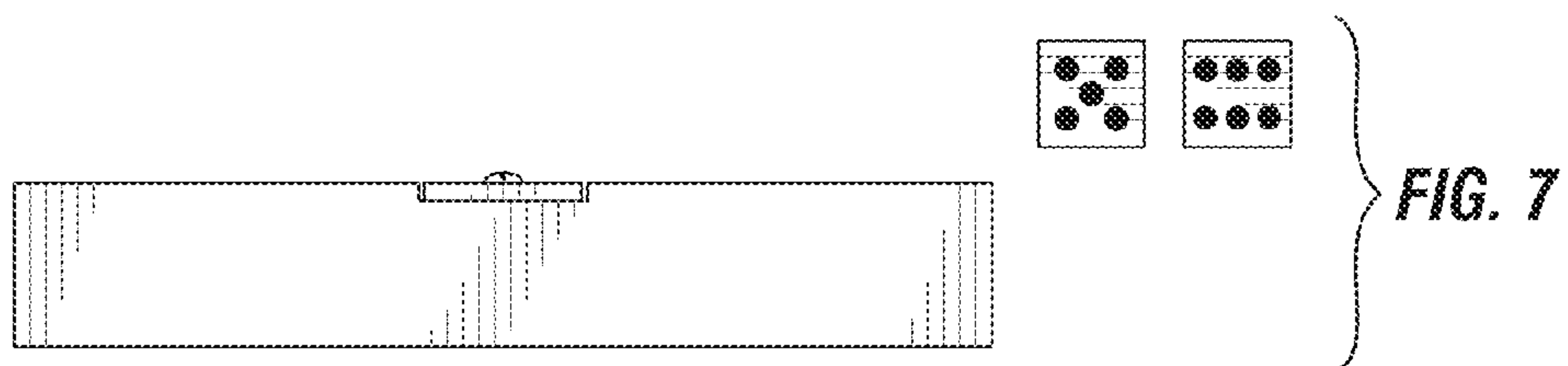
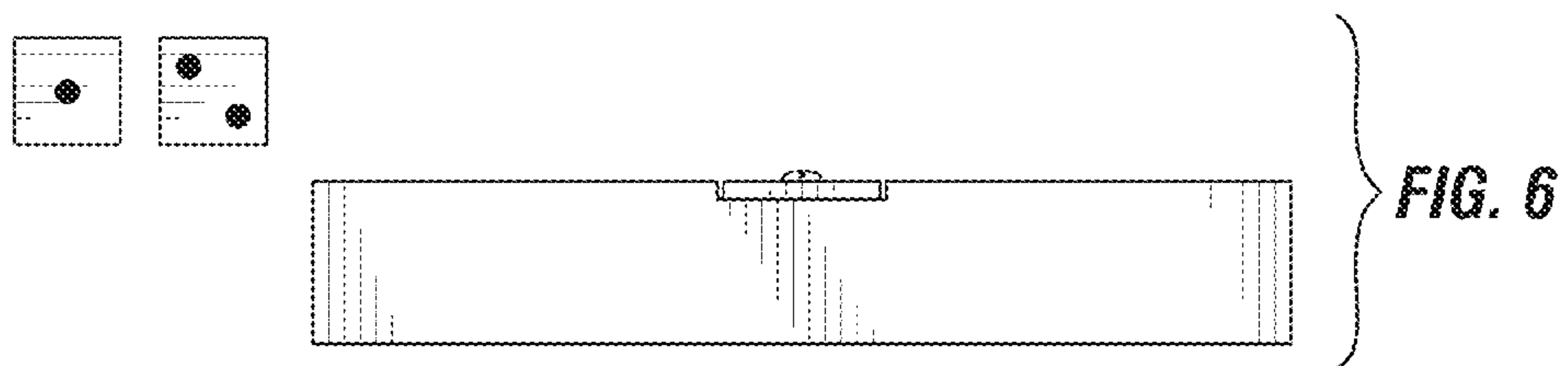
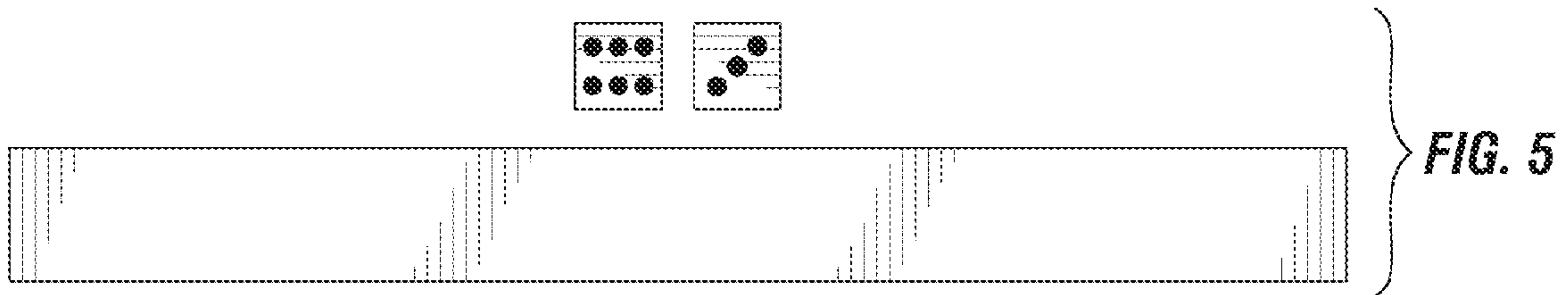
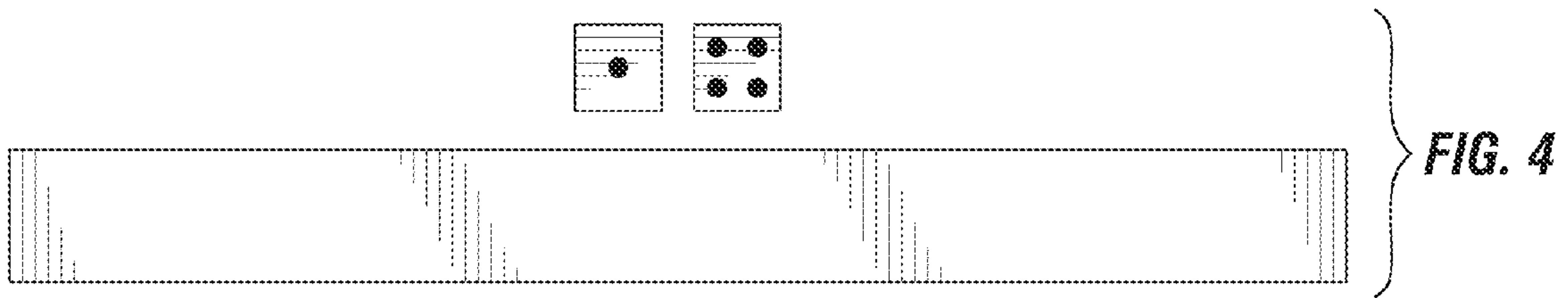

FIG. 1







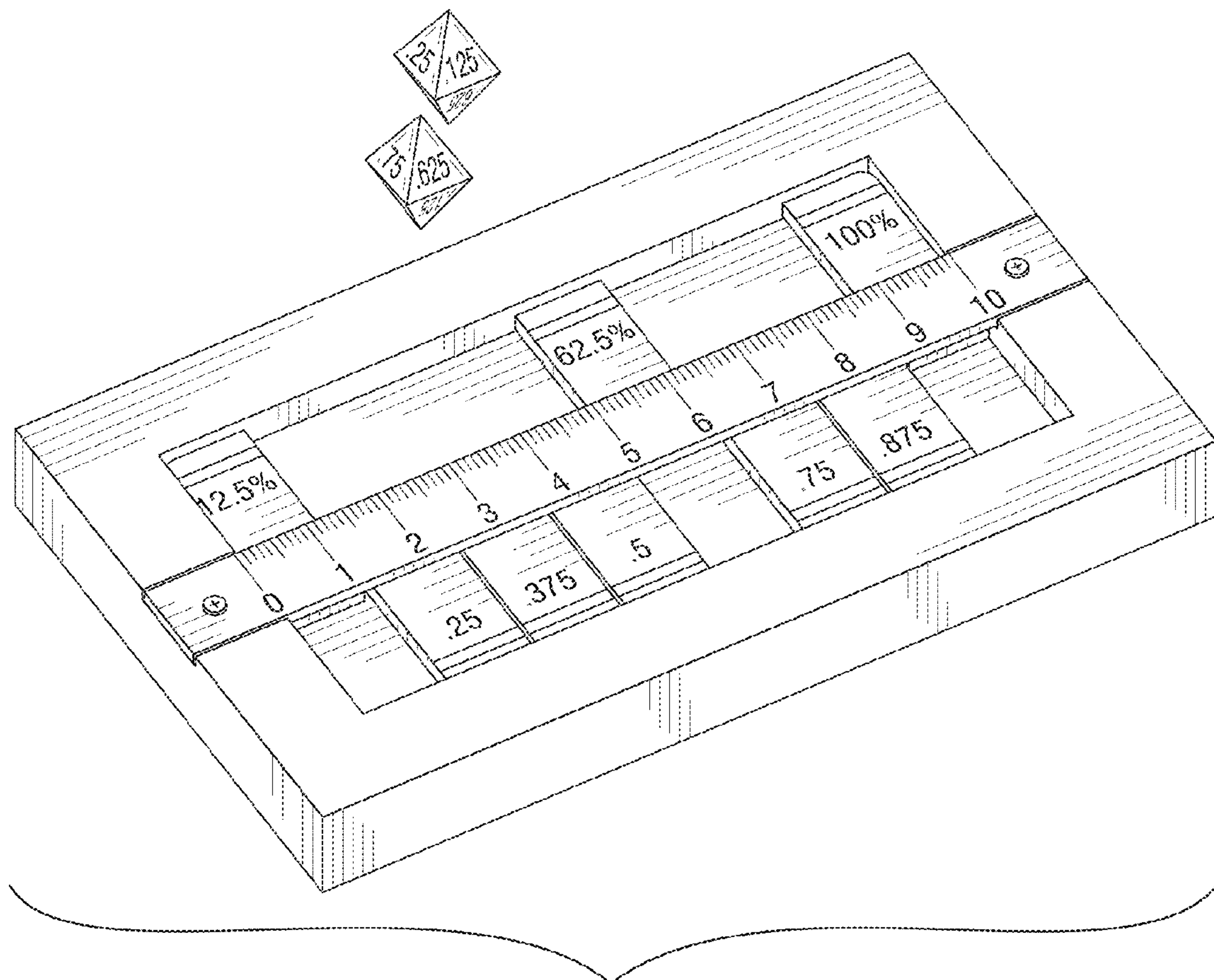

FIG. 8

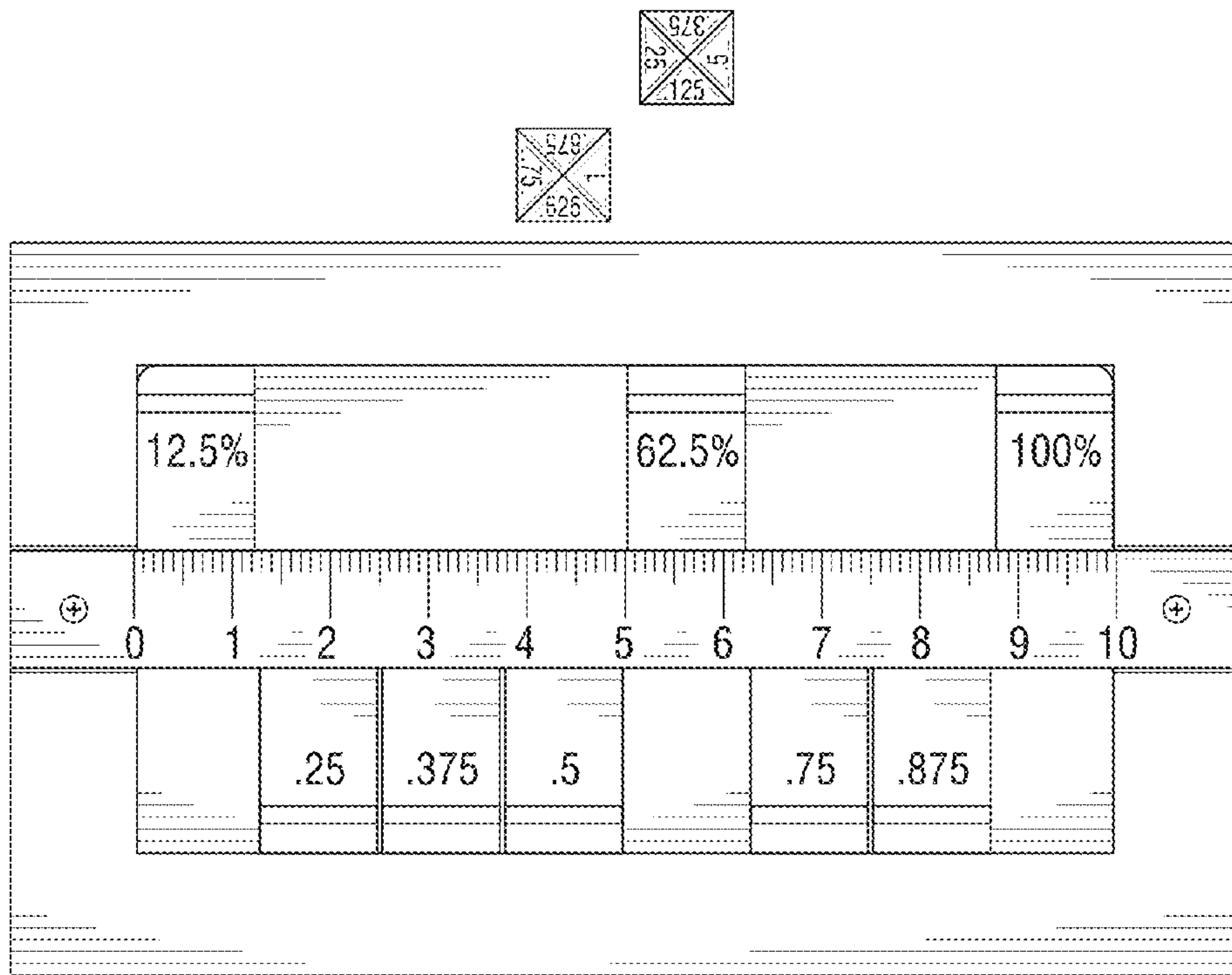

FIG. 9

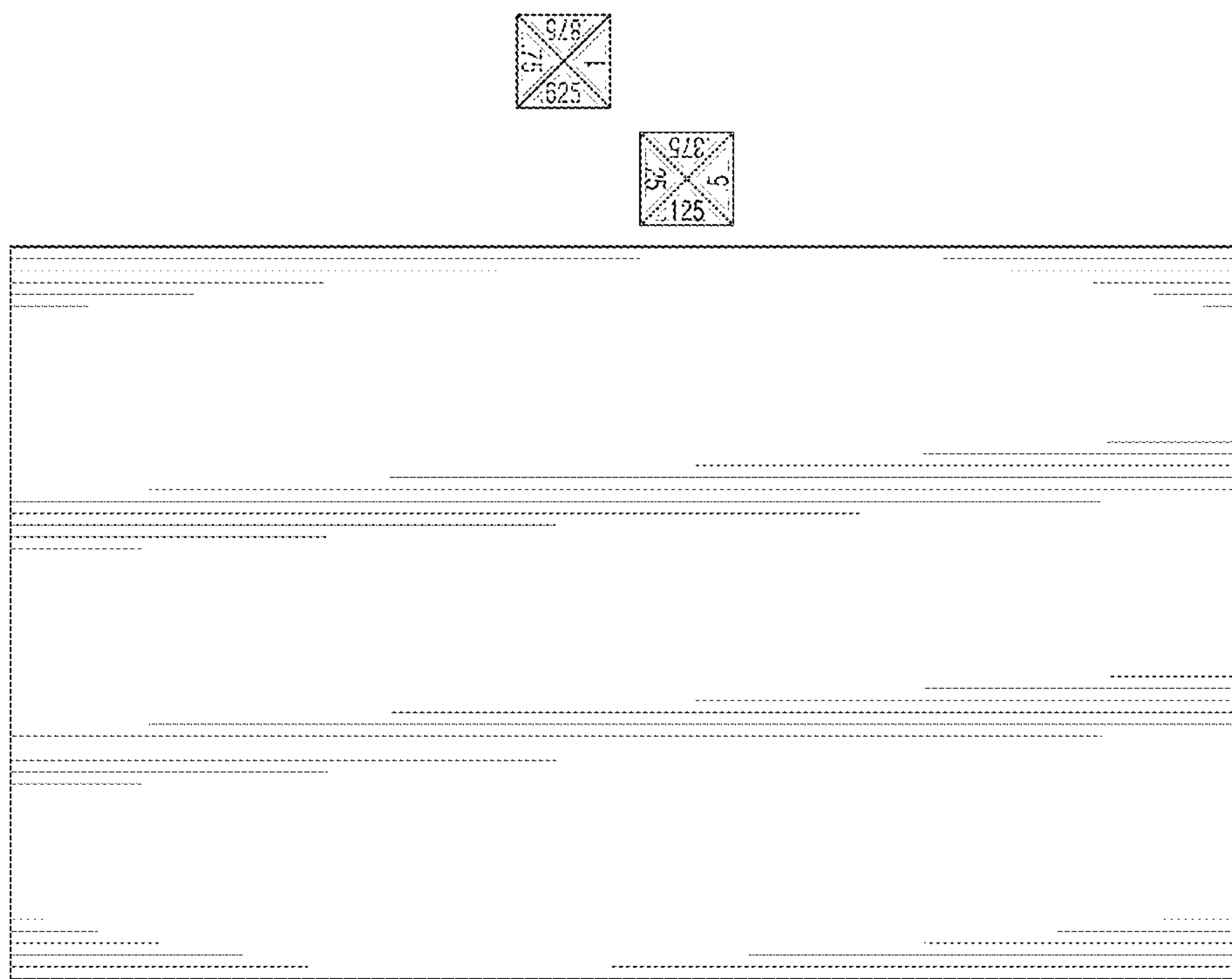

FIG. 10

