

US00D696558S

(12) **United States Design Patent**
Song

(10) **Patent No.:** **US D696,558 S**
(45) **Date of Patent:** **** Dec. 31, 2013**

- (54) **FOOD STORAGE CONTAINER**
- (71) Applicant: **Sunrise Kitchen Co., Ltd.**, Gunpo-si (KR)
- (72) Inventor: **Kwang Han Song**, Bucheon-si (KR)
- (73) Assignee: **Sunrise Kitchen Co., Ltd.**, Gunpo-si, Gyeonggi-do (KR)

D246,439	S	*	11/1977	Lynn et al.	D9/425
D266,049	S	*	9/1982	Conti	D7/602
D269,361	S	*	6/1983	Marschak	D3/302
D284,254	S	*	6/1986	Carlson	D7/629
D284,944	S	*	8/1986	Carlson	D9/425
5,036,646	A	*	8/1991	Makihara et al.	53/432
D330,161	S	*	10/1992	Schuh	D9/423
D330,996	S	*	11/1992	Smith et al.	D7/629
D332,917	S	*	2/1993	McDevitt et al.	D9/423
D336,017	S	*	6/1993	Smith et al.	D7/629

(Continued)

- (**) Term: **14 Years**
- (21) Appl. No.: **29/441,133**
- (22) Filed: **Dec. 31, 2012**
- (51) **LOC (9) Cl.** **07-01**
- (52) **U.S. Cl.**
USPC **D7/629**
- (58) **Field of Classification Search**
USPC D7/672, 601, 550.1, 551.1, 551.2, D7/551.3, 552.1, 552.2, 553.1, 553.2, D7/553.3, 553.4, 553.5, 553.7, 553.8, D7/554.1, 554.3, 554.4, 555, 557, 602, D7/629, 630, 538-542, 612-615, 584, 586, D7/587, 392.1, 709, 502, 608, 622; D9/424-432, 414-423; D3/273, D3/201-206, 276, 283, 284, 295, 274, D3/302; 229/107, 406, 120, 125.17, 4.5, 229/938; 220/669-673, 675, 574-575, 220/573.1, 4.21, 660, 326, 236, 780-795, 220/796-806, 4.24, 288, 260, 266, 306, 220/352, 356; 190/109, 110; 426/106; 206/216, 217, 541-550, 223, 467
See application file for complete search history.

OTHER PUBLICATIONS

Cambro 4SFSCW, [online], crawled on May 17, 2012, retrieved on Aug. 8, 2013. Retrieved from, <URL: <http://web.archive.org/web/20120517064010/http://www.zesco.com/Cambro-4SFSCW-135-4-Quart-Camsquare-Food-Storage-Containers-pz117D071.htm>>, 1 page.*

(Continued)

Primary Examiner — Rashida Johnson
Assistant Examiner — Shannon Morgan
(74) *Attorney, Agent, or Firm* — Novick, Kim & Lee, PLLC; Jae Youn Kim

(57) **CLAIM**
I claim the ornamental design for a food storage container, as shown and described.

DESCRIPTION

FIG. 1 is a top, front perspective view of a food storage container showing my new design;
FIG. 2 is a front elevational view thereof;
FIG. 3 is a rear elevational view thereof;
FIG. 4 is a left side elevational view thereof;
FIG. 5 is a right side elevational view thereof;
FIG. 6 is a top plan view thereof;
FIG. 7 is a bottom plan view thereof; and,
FIG. 8 is a sectional view taken along line 8-8 of FIG. 6 showing my new design.

1 Claim, 8 Drawing Sheets

- (56) **References Cited**
U.S. PATENT DOCUMENTS
D150,045 S * 6/1948 Zaikaner D7/629
D159,811 S * 8/1950 Hill D7/629
2,857,947 A * 10/1958 Powers 220/799
3,338,468 A * 8/1967 Wilson 206/508

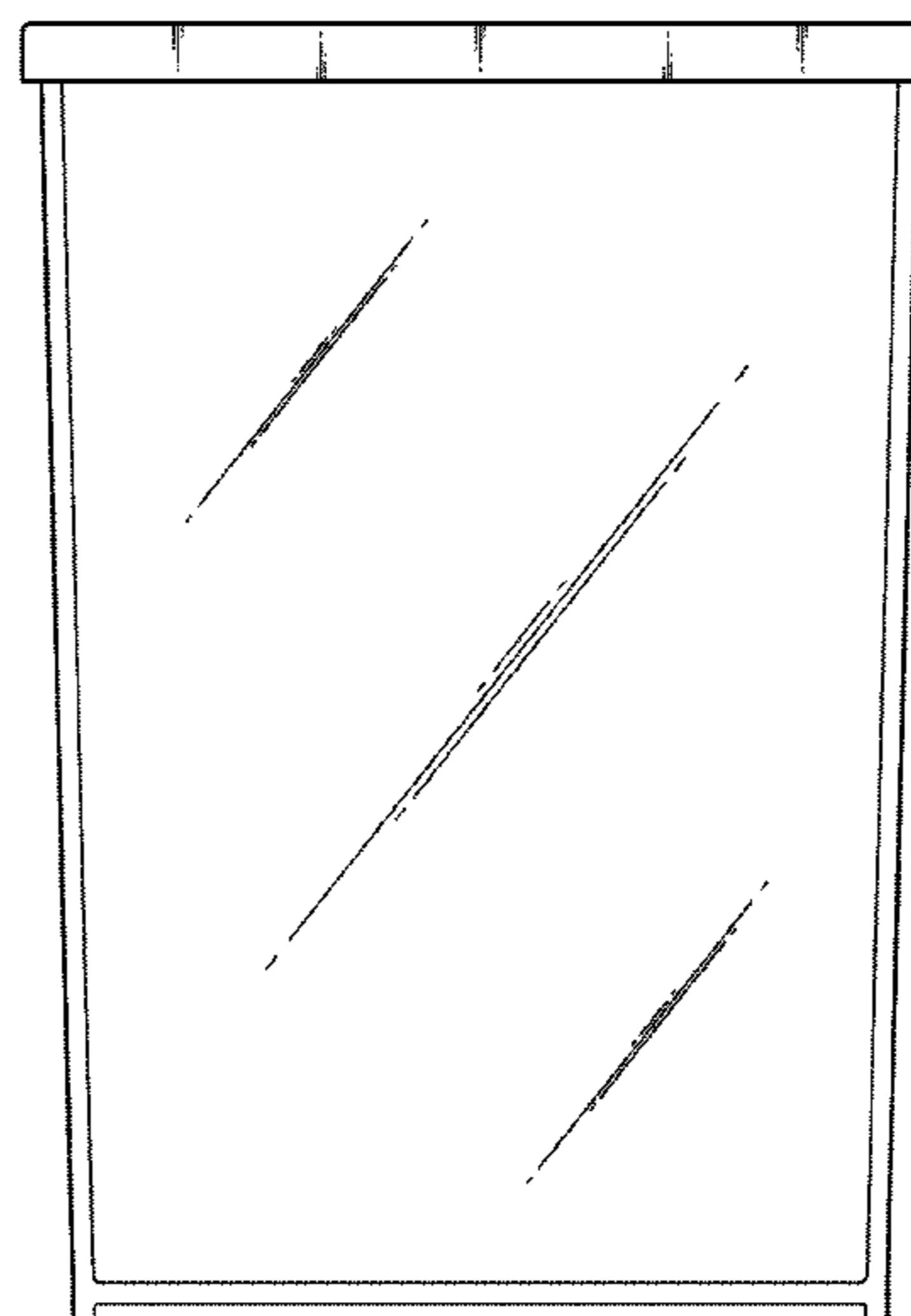
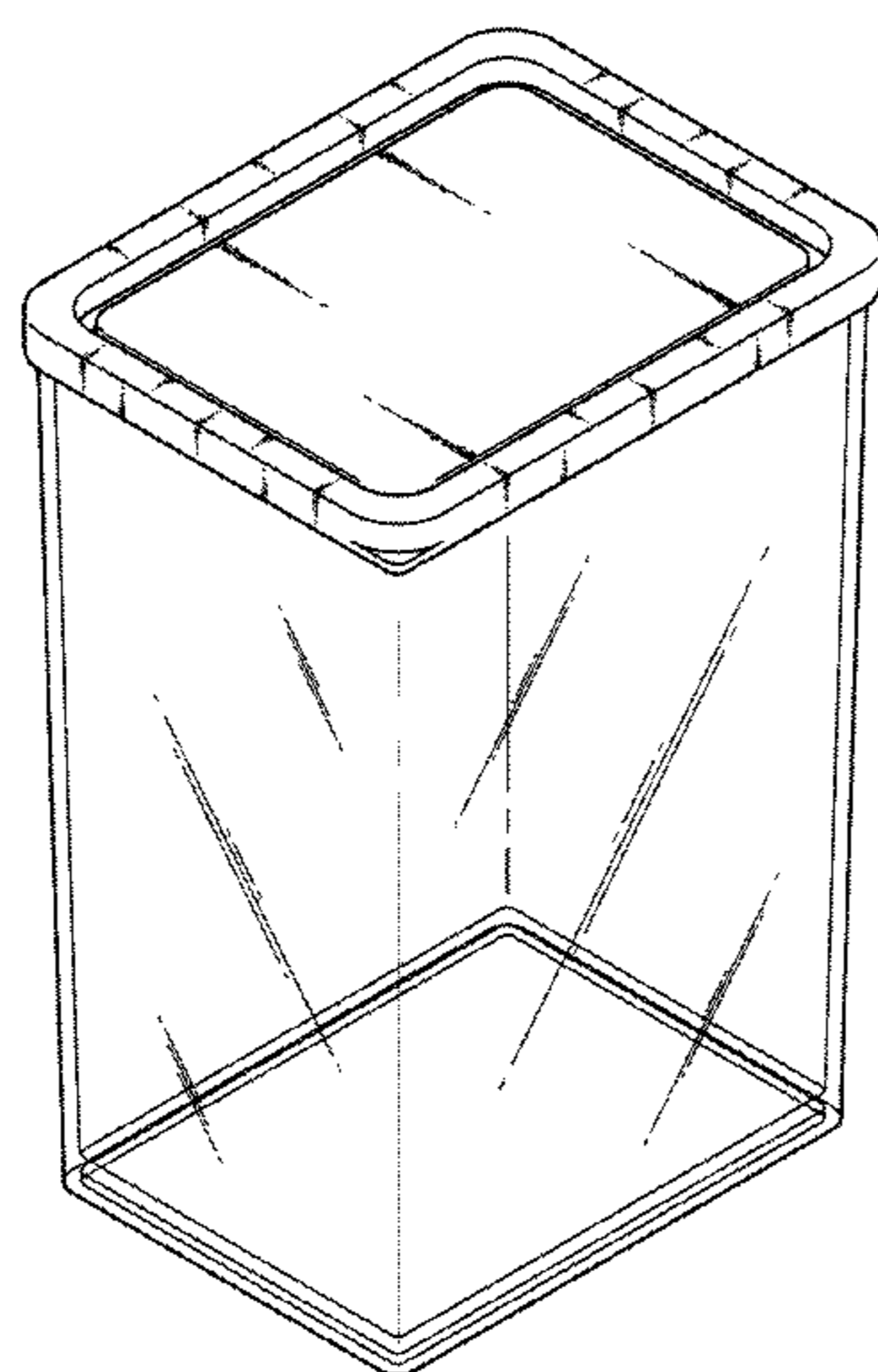

(56)

References Cited

U.S. PATENT DOCUMENTS

5,219,087	A *	6/1993	Christensson	220/270
D342,815	S *	12/1993	Shafer	D34/1
5,868,309	A *	2/1999	Sandstrom et al.	229/400
D418,056	S *	12/1999	Johnson	D9/431
D587,566	S *	3/2009	Albrecht	D9/424
D595,128	S *	6/2009	Bouveret et al.	D9/425
D646,119	S *	10/2011	Deuber	D7/400
D662,783	S *	7/2012	Lee	D7/602
D664,845	S *	8/2012	Everson	D9/432
2005/0115509	A1 *	6/2005	Rudolph	119/165

OTHER PUBLICATIONS

Cambro 6SFSCW, [online], retrieved on Aug. 8, 2013. Retrieved from, <URL: <http://www.globequipment.com/Kitchen-Supplies/Food-Storage-And-Transport/Square-Food-Storage-Containers/6sfscw>>, 1 page.*

* cited by examiner

FIG. 1

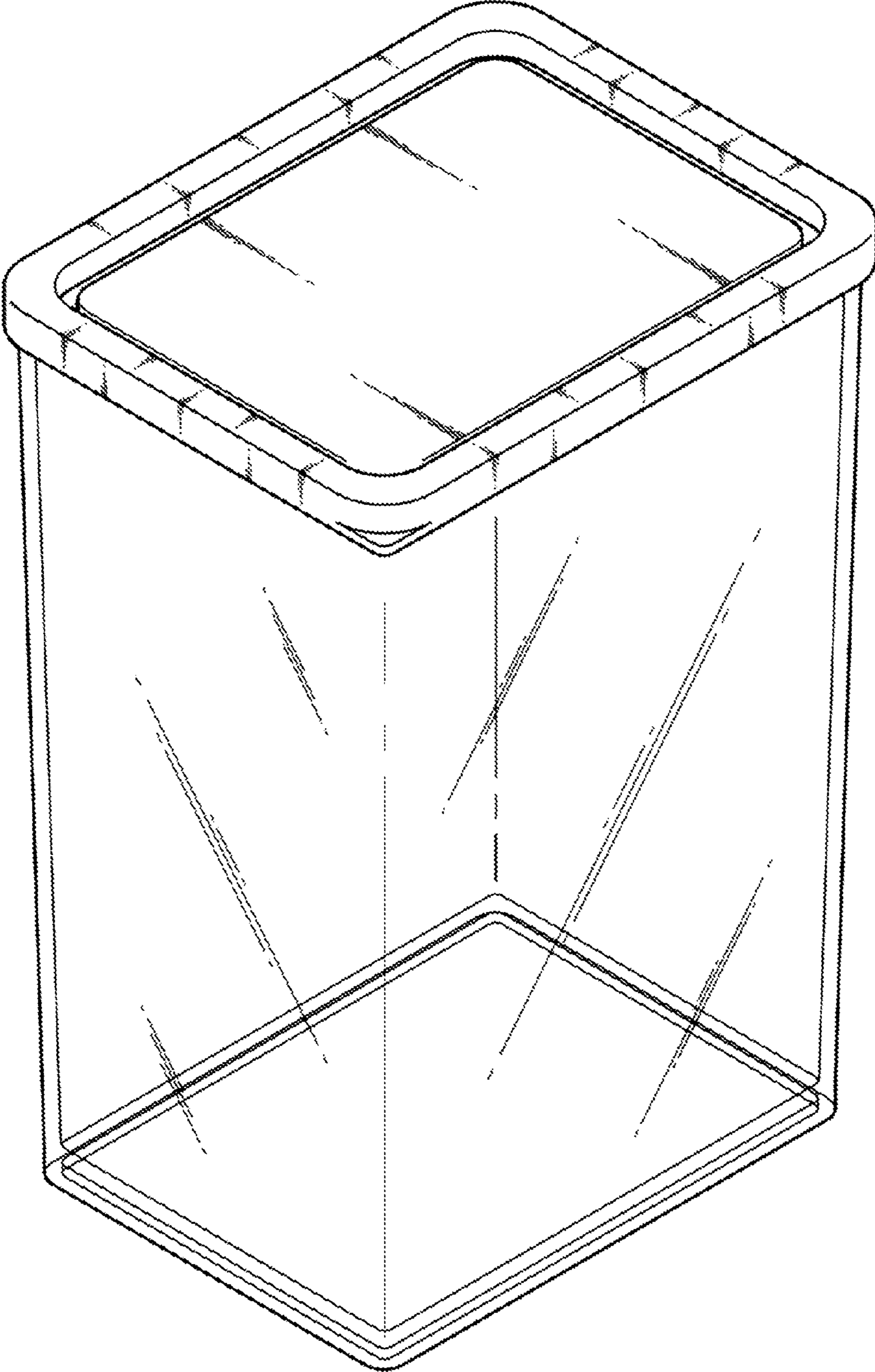

FIG. 2

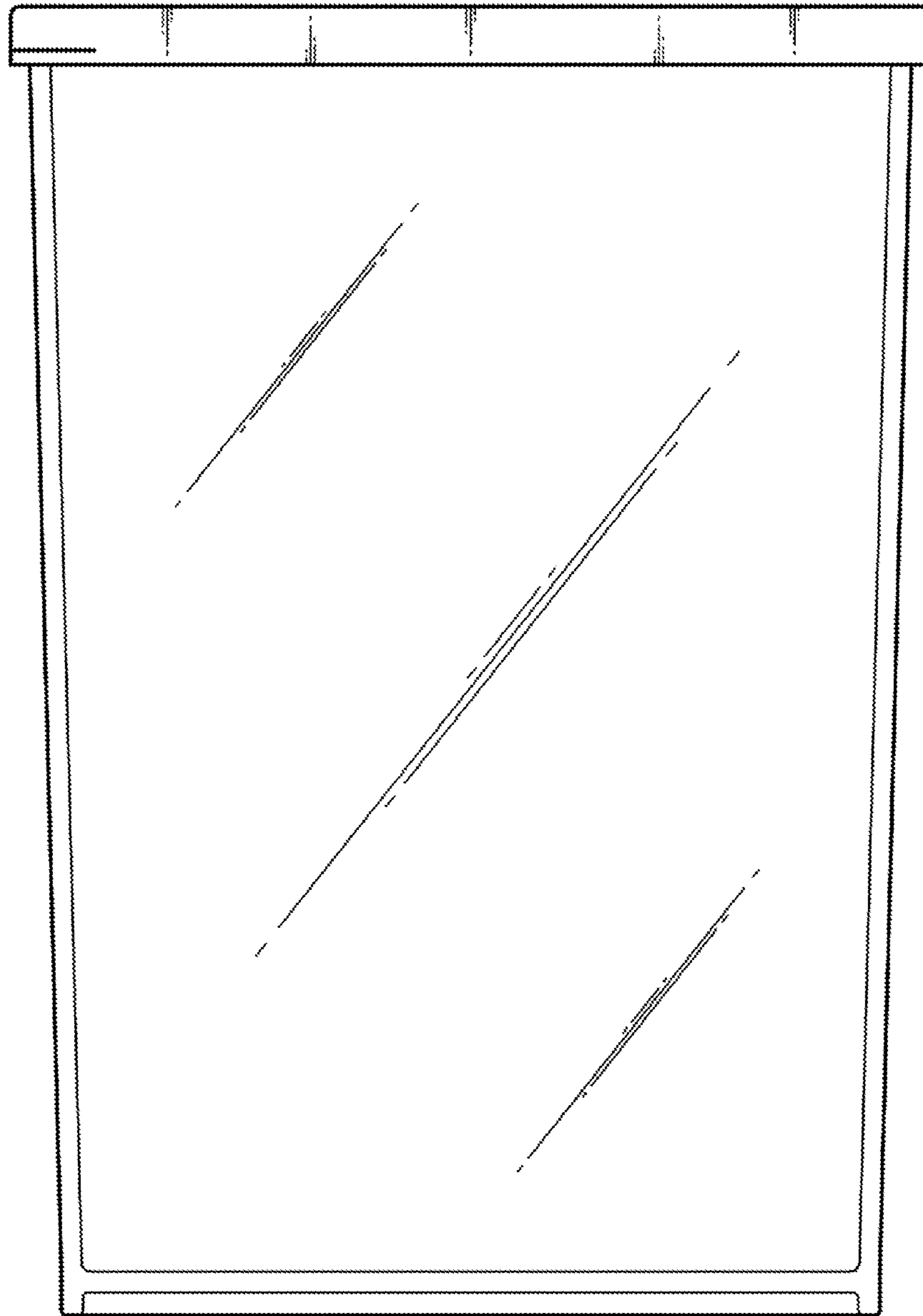

FIG. 3

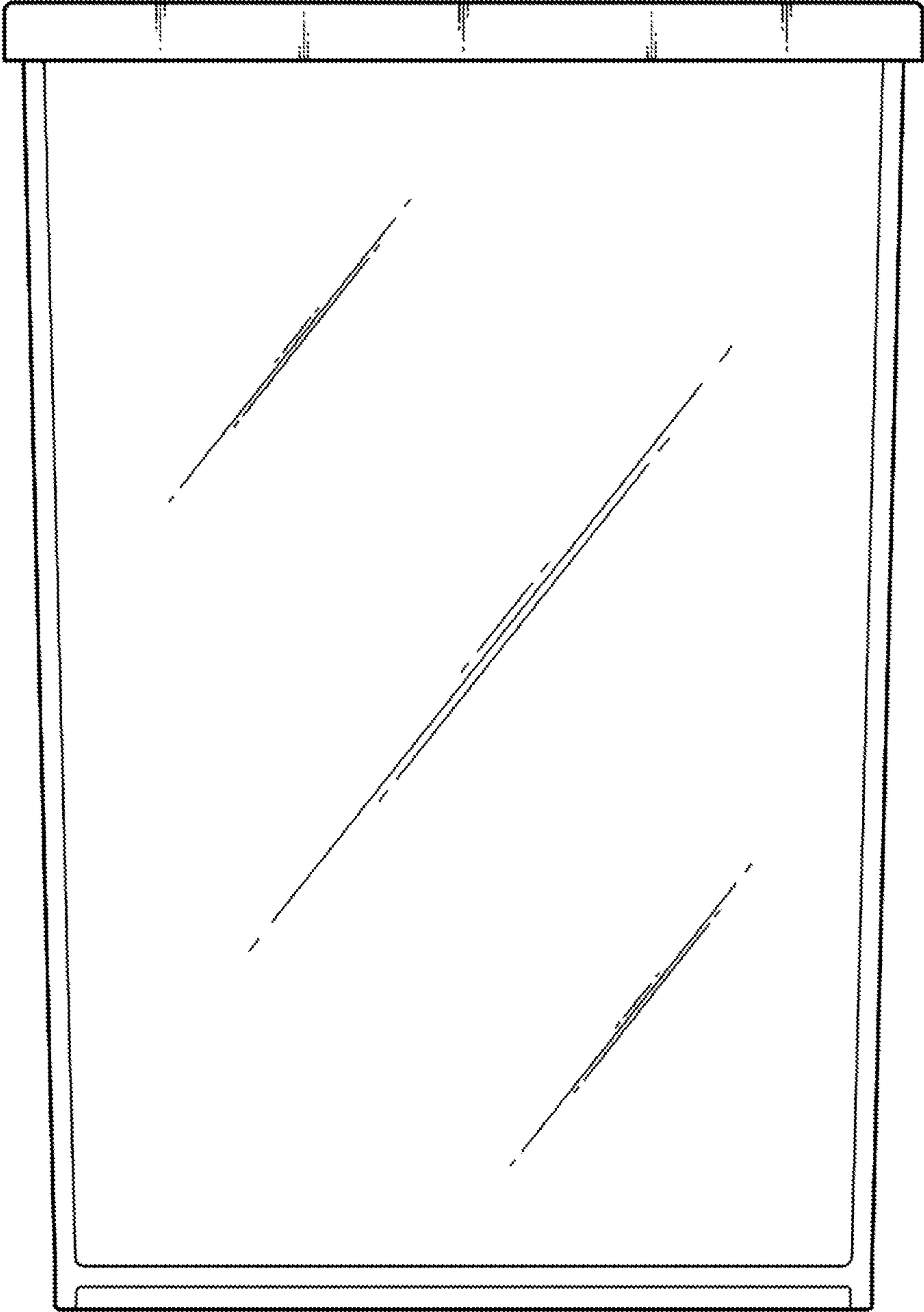

FIG. 4

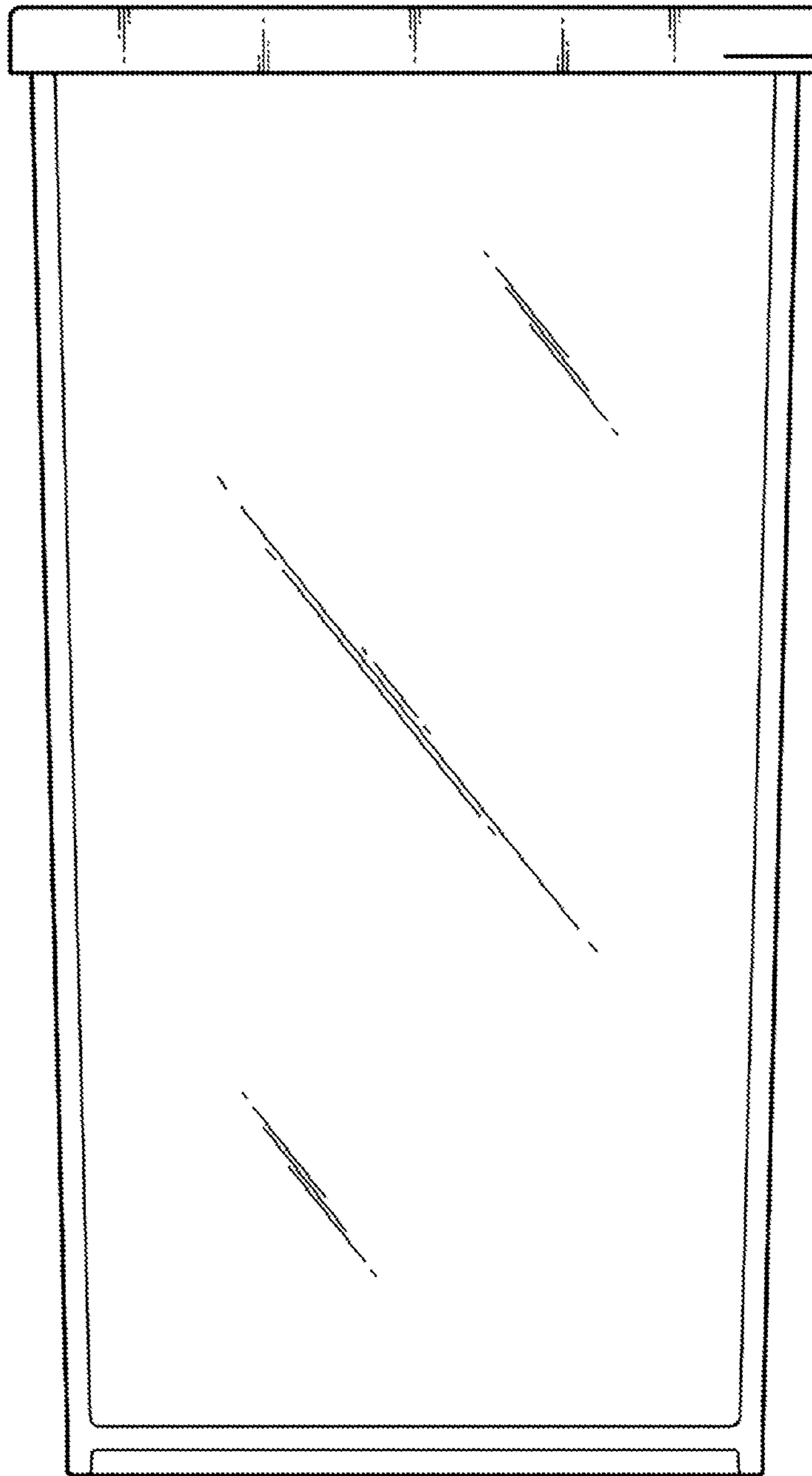

FIG. 5

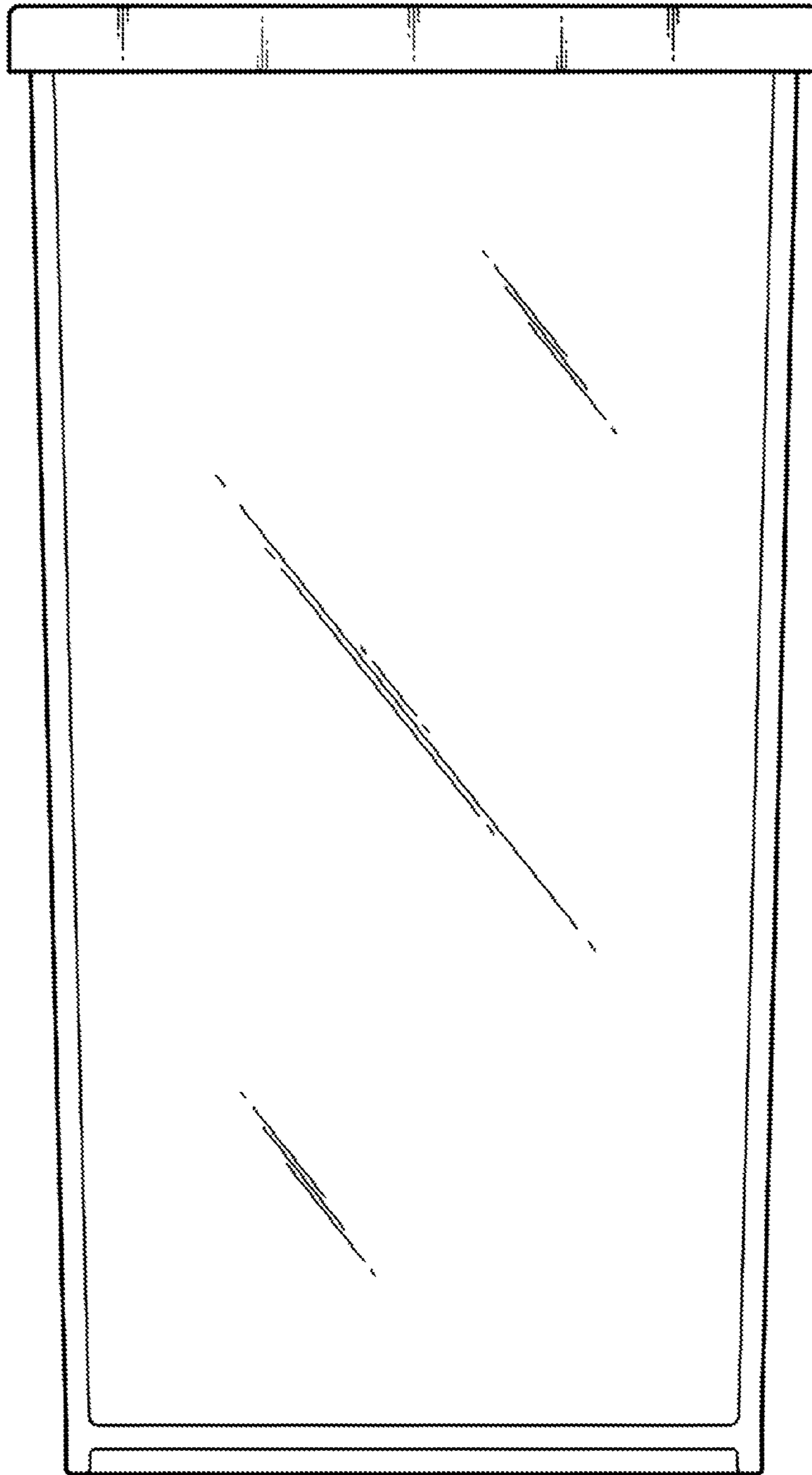

FIG. 6

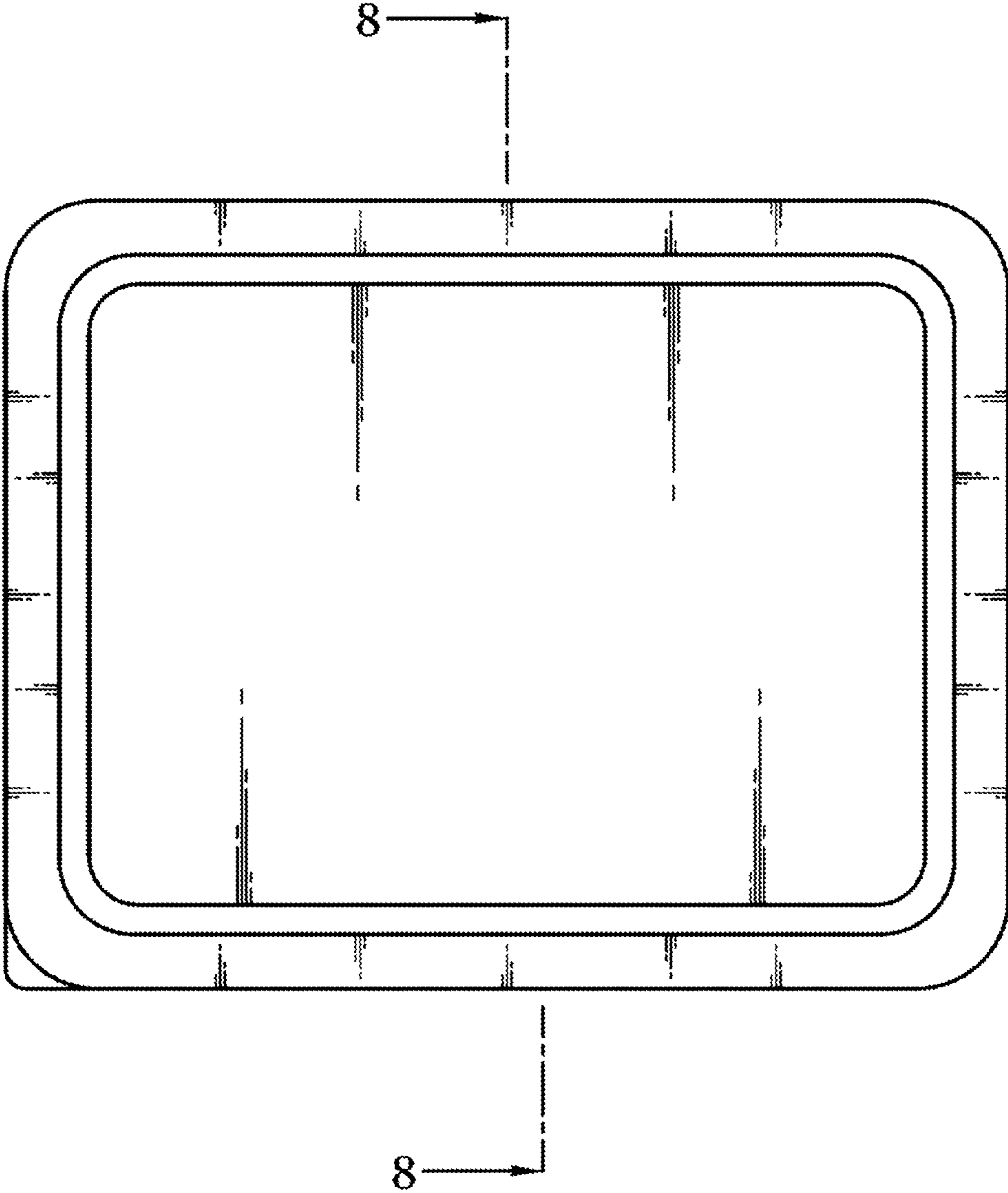

FIG. 7

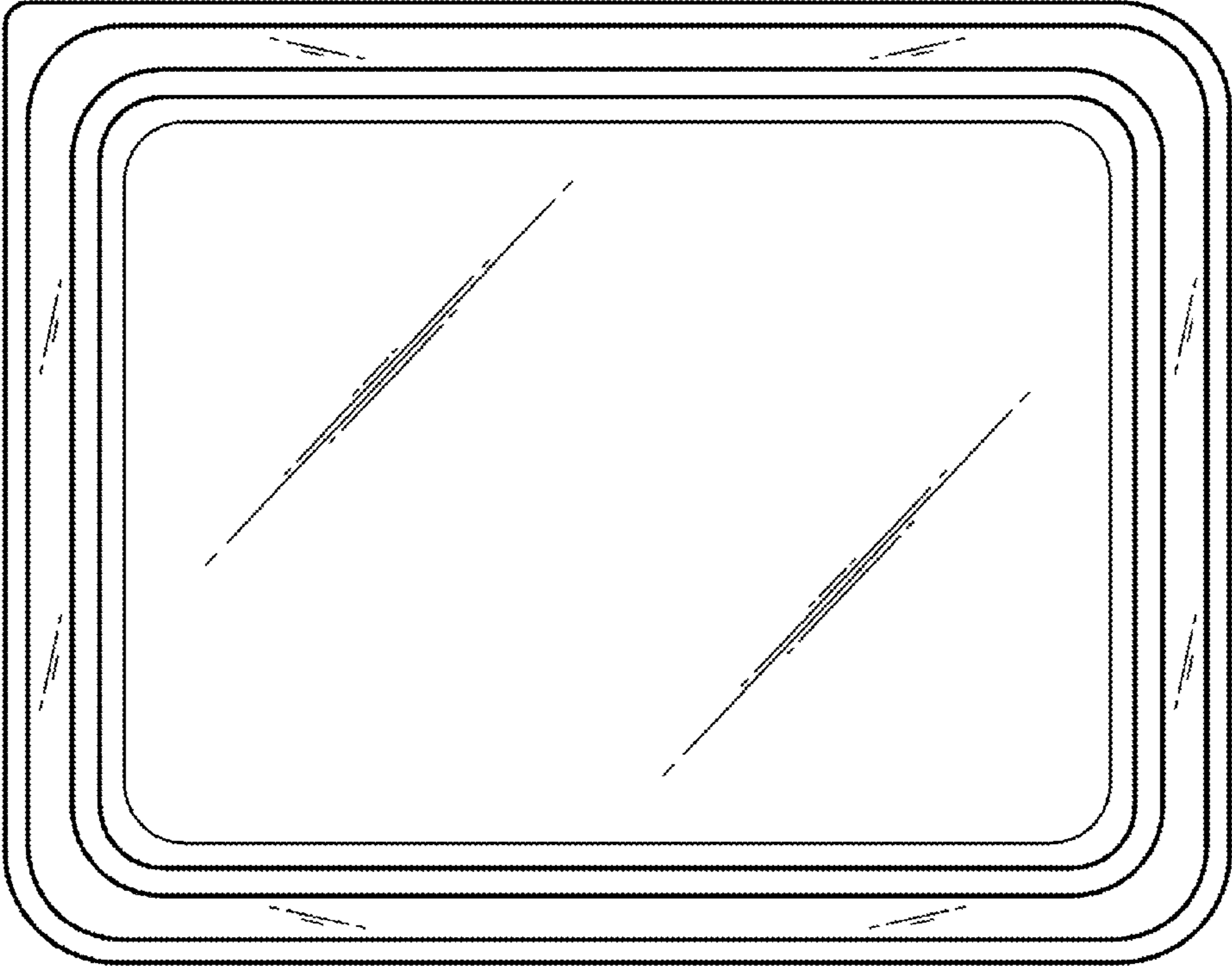

FIG. 8

