



US00D696488S

(12) **United States Design Patent**
Kenney et al.

(10) **Patent No.:** **US D696,488 S**

(45) **Date of Patent:** **** Dec. 31, 2013**

(54) **SHIRT**

(71) Applicant: **NIKE, Inc.**, Beaverton, OR (US)

(72) Inventors: **Kimberly Kenney**, Beaverton, OR (US);
Marguerite Hill Nelson, Portland, OR (US)

(73) Assignee: **NIKE, Inc.**, Beaverton, OR (US)

(**) Term: **14 Years**

(21) Appl. No.: **29/455,256**

(22) Filed: **May 17, 2013**

(51) **LOC (9) Cl.** **02-02**

(52) **U.S. Cl.**
USPC **D2/840**

(58) **Field of Classification Search**
USPC D2/717, 720, 739, 749, 750, 840, 841,
D2/844; 2/90, 104, 105, 106, 115
See application file for complete search history.

(56) **References Cited**

U.S. PATENT DOCUMENTS

448,442 A	3/1891	Hyman	
D76,457 S	10/1928	Burr	
D113,824 S	3/1939	Stricker	
D151,776 S	11/1948	Levine	
D164,691 S	10/1951	Kaye	
D192,135 S	1/1962	Tiso	
3,078,699 A *	2/1963	Huntley	66/176
D250,146 S	11/1978	Morgan	
D259,746 S	7/1981	Dahlgard	
D278,477 S	4/1985	Mizuno	
D299,280 S	1/1989	Williams	
5,105,478 A *	4/1992	Pyc	2/115
5,608,913 A	3/1997	Lacoste	
5,692,239 A	12/1997	Lewis	
6,148,445 A	11/2000	Spruill	
D438,365 S	3/2001	Matrasingh	
D457,709 S *	5/2002	Davis	D2/717

6,694,528 B1	2/2004	Chang	
D491,713 S	6/2004	Wilson et al.	
D505,768 S	6/2005	Dallas et al.	
D512,552 S *	12/2005	Benini	D2/853
D525,412 S *	7/2006	O'Mahony	D2/717
D550,427 S *	9/2007	Moore	D2/717
D564,182 S *	3/2008	Wiens	D2/840
7,356,851 B2	4/2008	Spruill	
D619,783 S *	7/2010	Jones et al.	D2/717

(Continued)

OTHER PUBLICATIONS

ebay. <http://www.ebay.com/itm/Adidas-Clima365-Climacool-Formation-Soccer-Jersey-Shirt-Mens-M-Football-/400585504148>.
Oct. 2013. "Adidas Clima365 Climacool Formation Soccer Jersey Shirt".*

(Continued)

Primary Examiner — Rashida Johnson

(74) *Attorney, Agent, or Firm* — Banner & Witcoff, Ltd.

(57) **CLAIM**

The ornamental design for a shirt, as shown and described.

DESCRIPTION

FIG. 1 is a rear perspective view of a shirt showing our new design;

FIG. 2 is a rear view thereof;

FIG. 3 is a front view thereof;

FIG. 4 is a right side view thereof;

FIG. 5 is a left side view thereof; and,

FIG. 6 is a top view thereof.

The broken lines immediately adjacent to the shaded area represent unclaimed boundaries of the design. The contrast in shading represents a contrast in appearance only and does not represent any particular color, material, texture or finish. The broken lines showing the remainder of the shirt are for environmental purposes only and form no part of the claimed design.

1 Claim, 6 Drawing Sheets

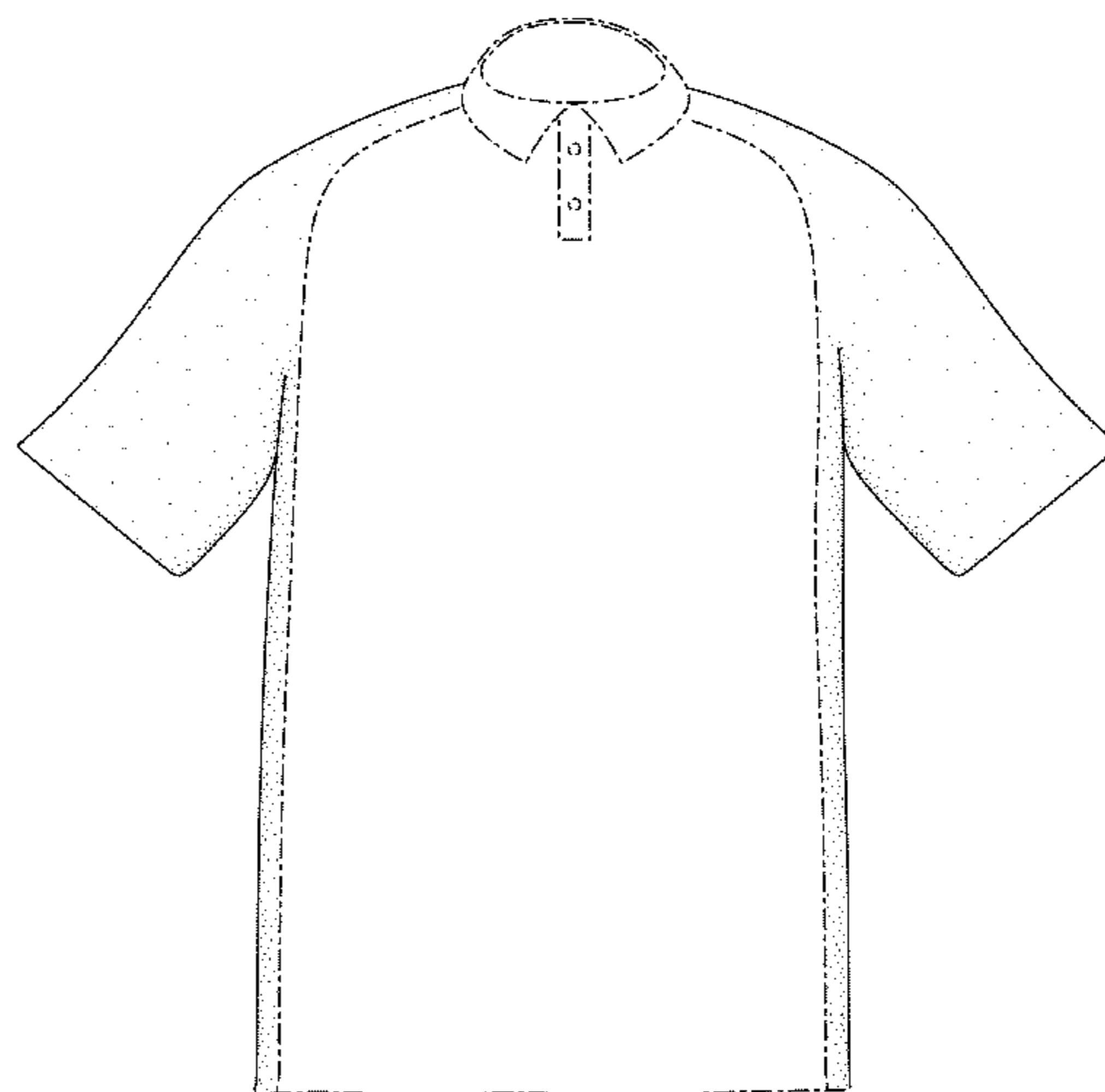
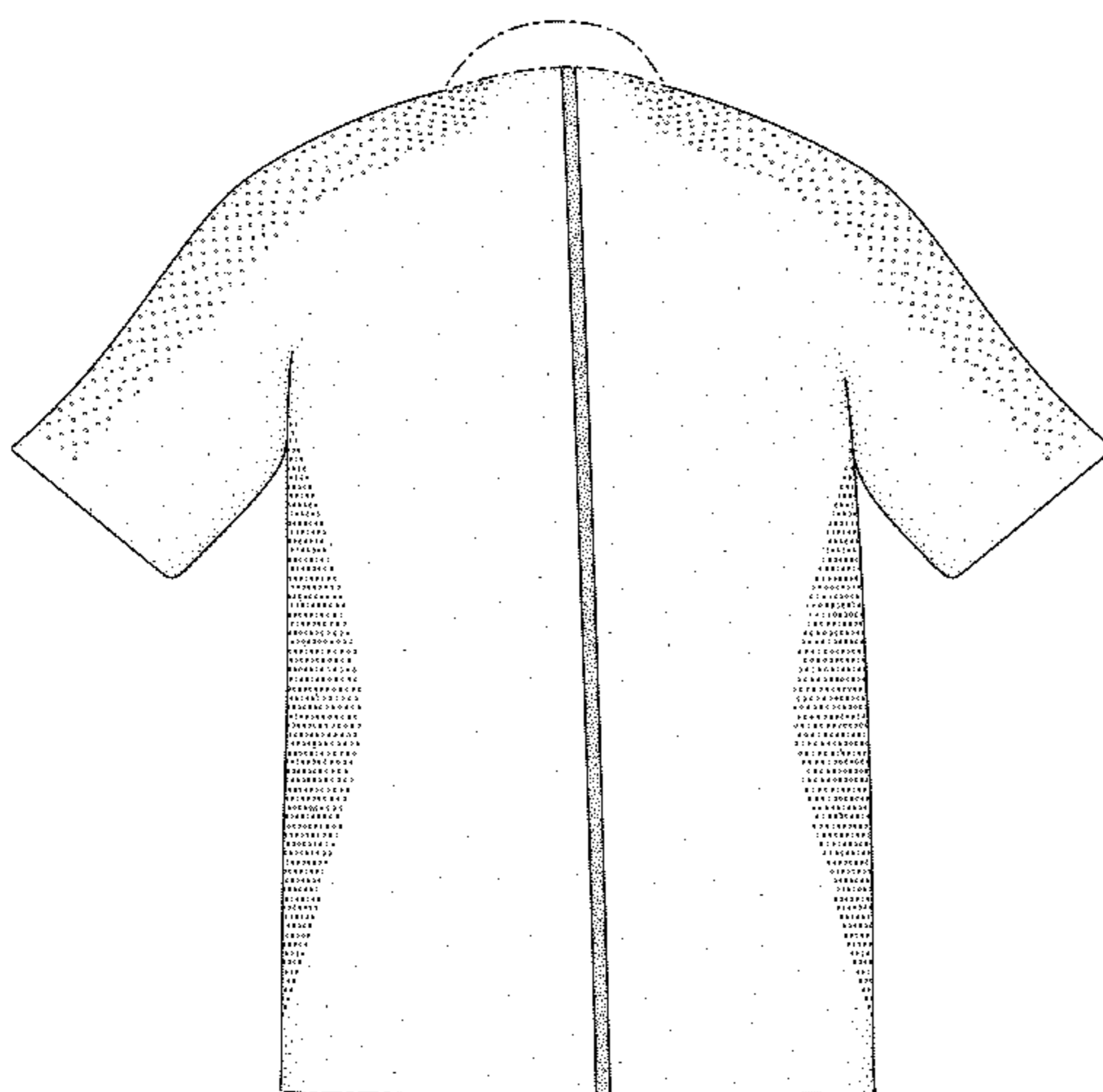

(56)

References Cited

U.S. PATENT DOCUMENTS

D629,588 S 12/2010 Scott-Curran
7,913,323 B2 3/2011 Takamoto et al.
7,941,871 B1 5/2011 Jorgensen
D648,925 S * 11/2011 Anderson et al. D2/849
D649,331 S * 11/2011 Lambertz D2/714
D650,154 S 12/2011 Saavedra
8,087,095 B2 1/2012 Maier
2002/0078485 A1 6/2002 Ferreiro
2005/0015865 A1* 1/2005 Chaix et al. 2/456
2007/0028351 A1 2/2007 Coolik

2007/0294801 A1 12/2007 Furgerson et al.
2010/0218298 A1 9/2010 Stattelmann et al.
2010/0229278 A1* 9/2010 Bates 2/115
2010/0242151 A1* 9/2010 Mather 2/115
2011/0302686 A1 12/2011 Chapuis
2012/0128943 A1 5/2012 Wangbunyen et al.

OTHER PUBLICATIONS

Kickrs. <http://www.kckrs.com/the-new-us-soccer-jersey-will-spawn-a-million-where-waldo-jokes/>. Apr. 2012. US Soccer Jersey.*

* cited by examiner

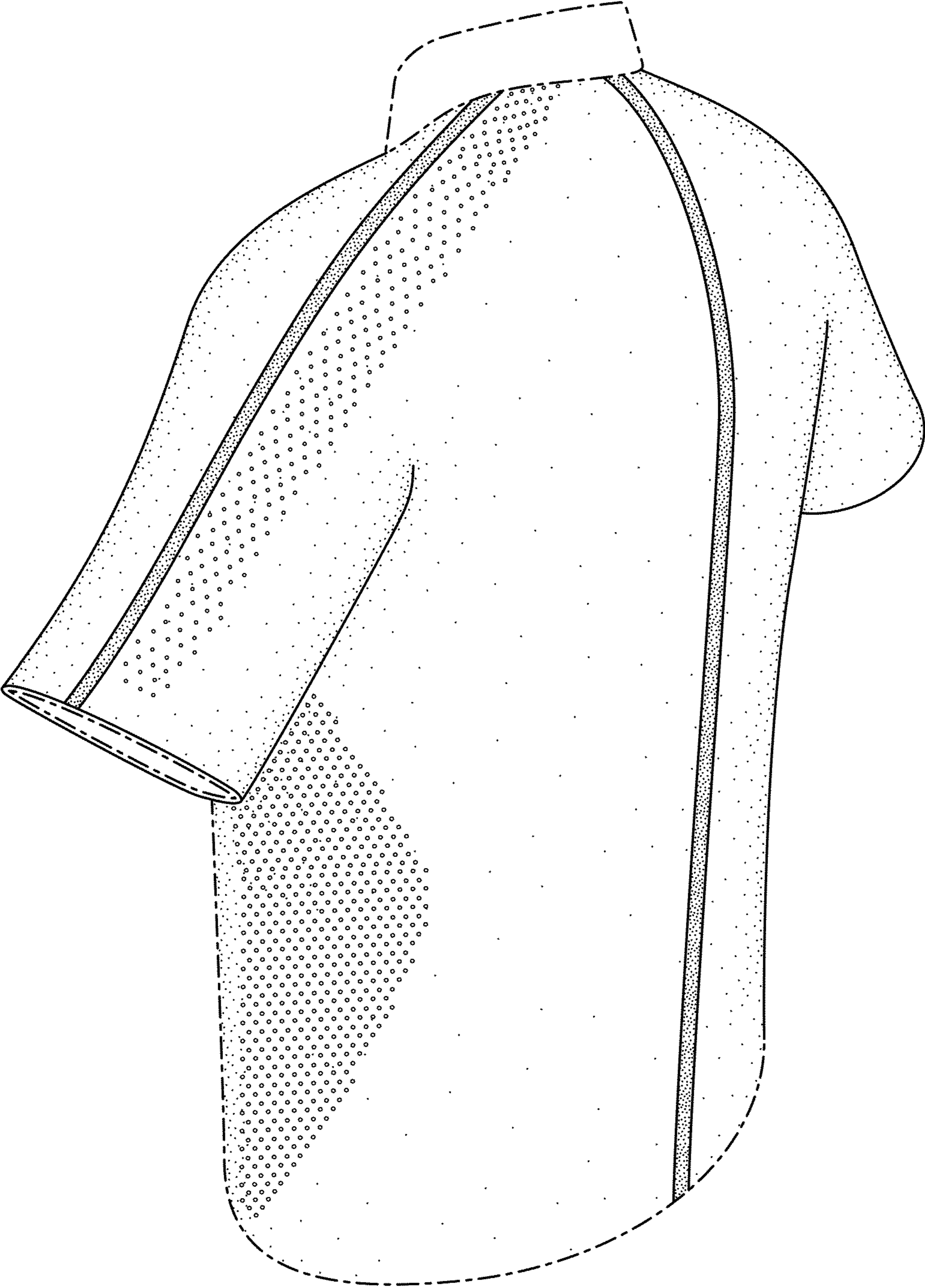

FIG. 1

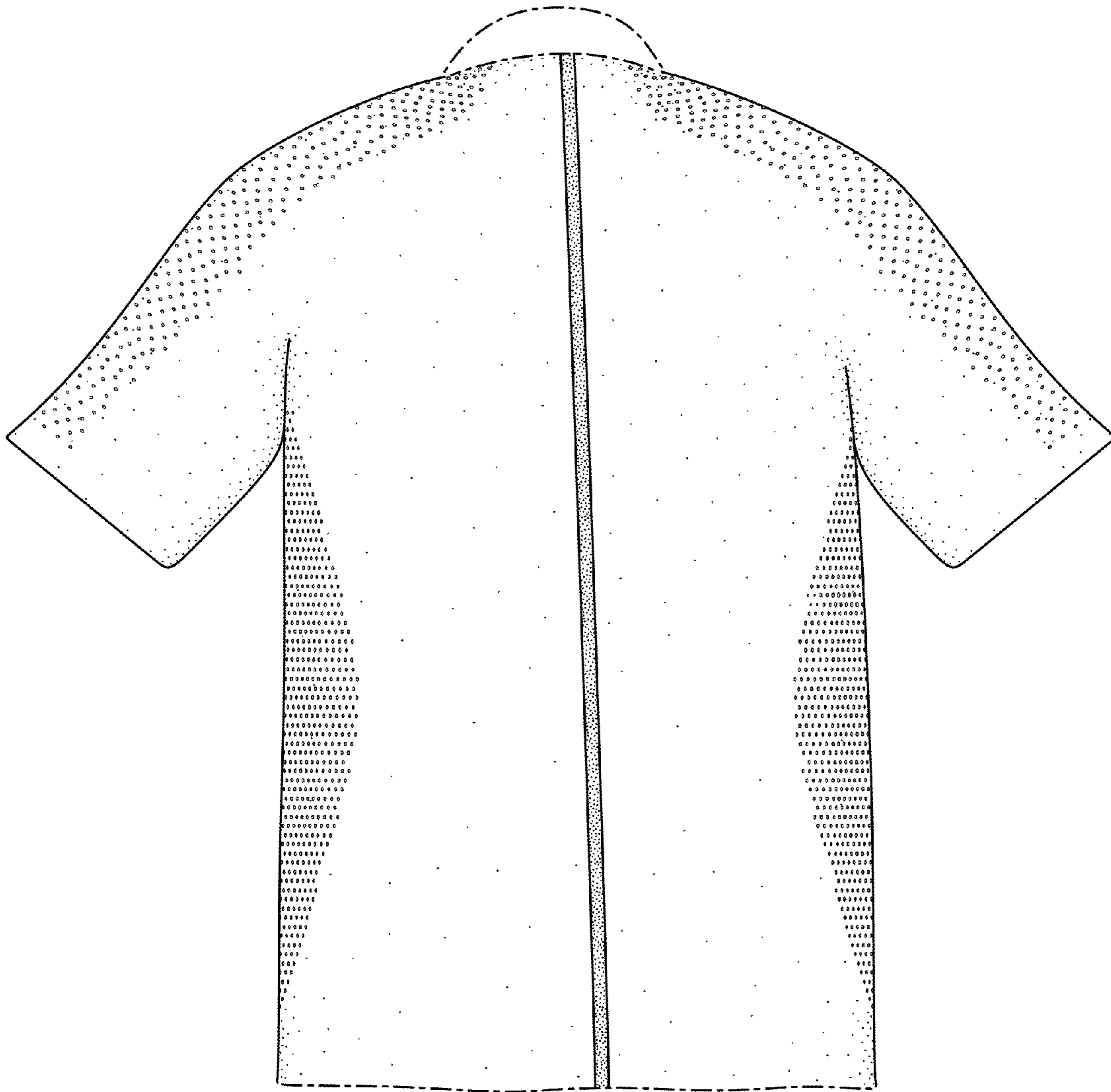

FIG. 2

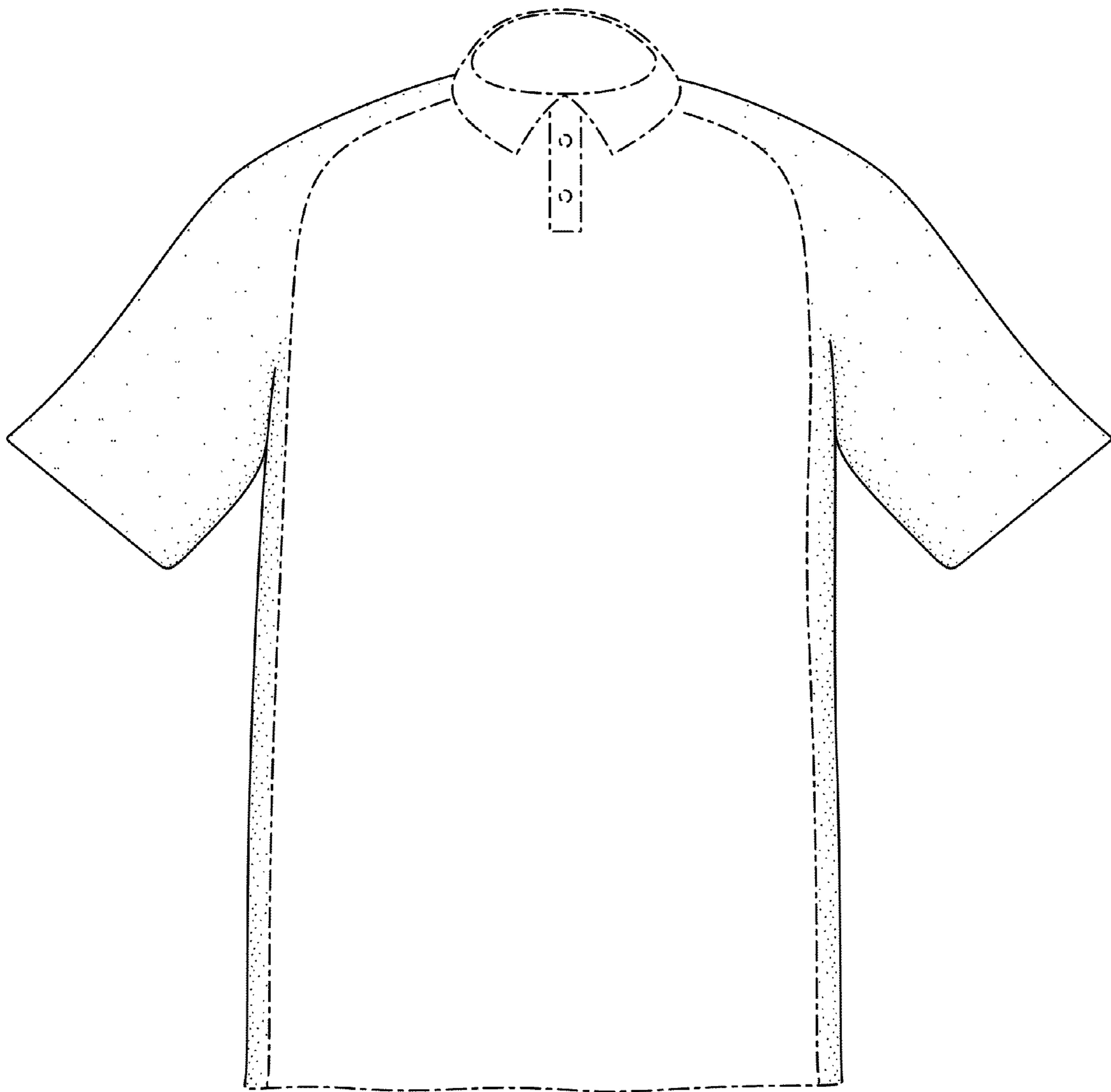

FIG. 3

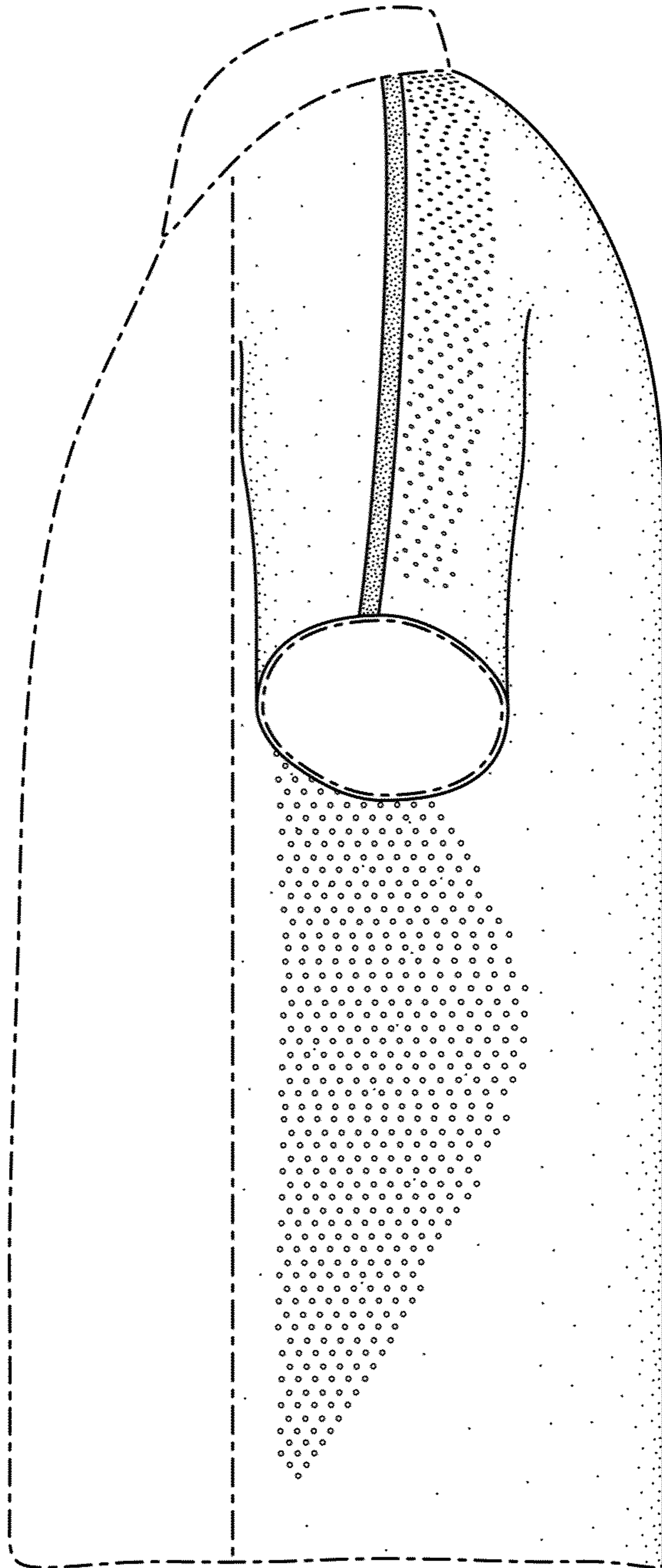

FIG. 4

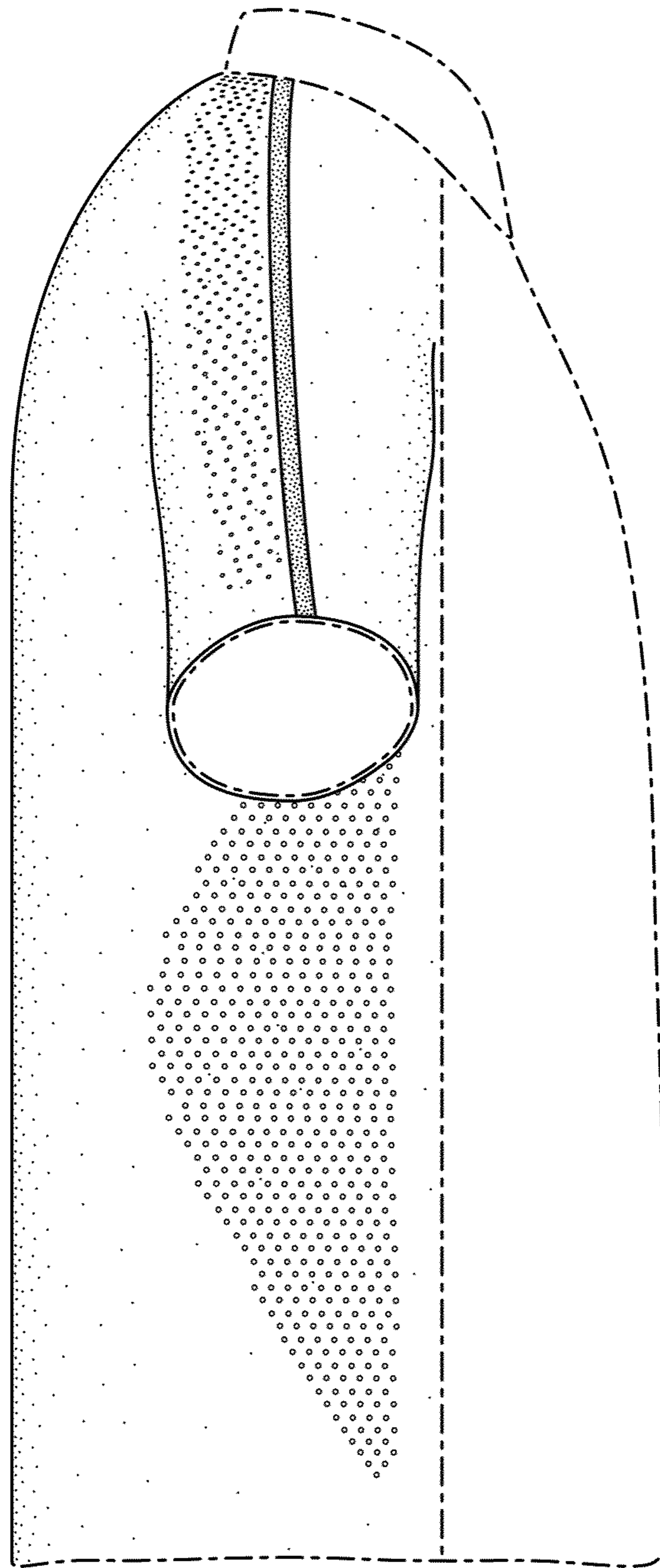

FIG. 5

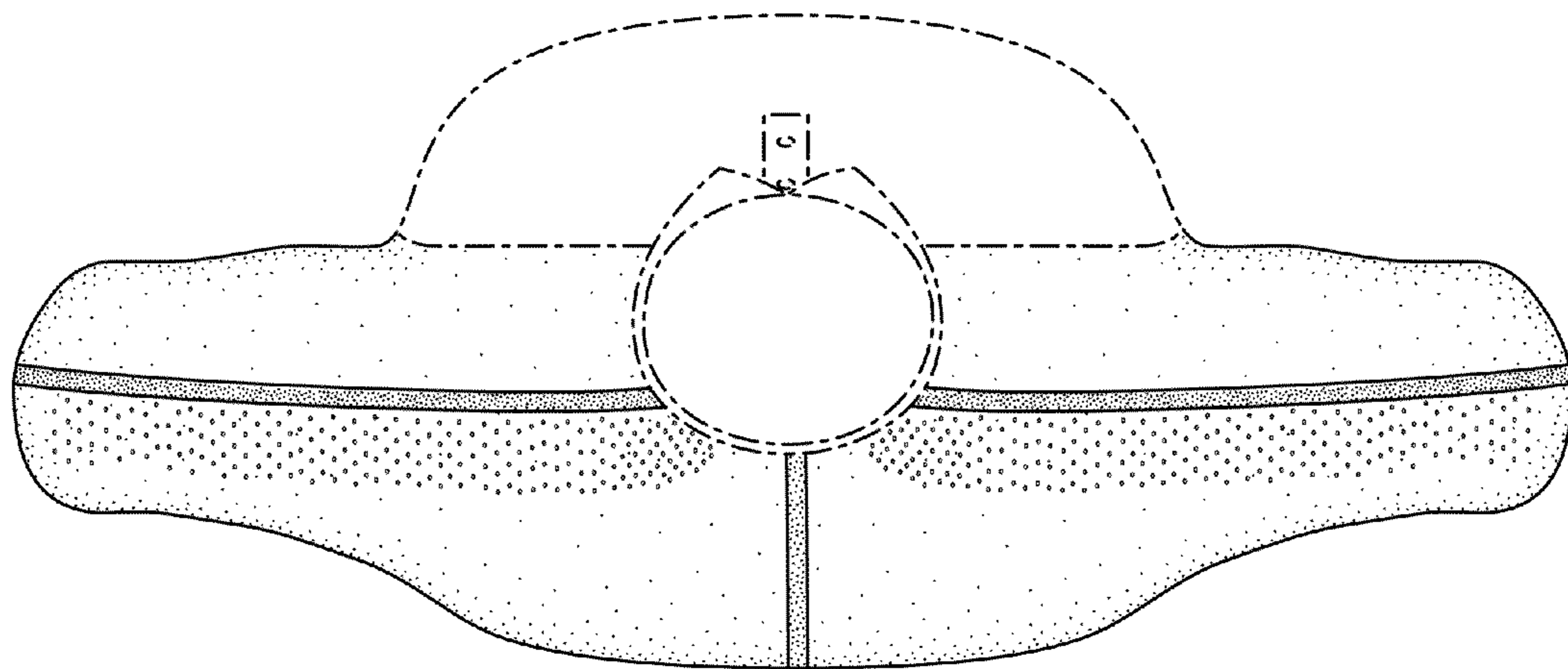

FIG. 6