

US00D696413S

(12) **United States Design Patent**
Tai

(10) **Patent No.:** **US D696,413 S**

(45) **Date of Patent:** **** Dec. 24, 2013**

(54) **PERSONAL MASSAGER**

(71) Applicant: **GS Design HK, Limited**, Admiralty (HK)

(72) Inventor: **Kenny Chih-Yao Tai**, Admiralty (HK)

(73) Assignee: **GS Design HK, Limited**, Admiralty (HK)

(**) Term: **14 Years**

(21) Appl. No.: **29/441,804**

(22) Filed: **Jan. 9, 2013**

(51) **LOC (9) Cl.** **28-03**

(52) **U.S. Cl.**
USPC **D24/215**

(58) **Field of Classification Search**
USPC D24/200, 211–215, 141; 601/27, 28, 601/33, 40, 46, 47, 48, 63, 80, 99, 104, 112, 601/113, 114, 119, 122, 125, 129, 134, 135, 601/137, DIG. 12, DIG. 13, DIG. 14, 601/DIG. 15, DIG. 16, DIG. 17
See application file for complete search history.

(56) **References Cited**

U.S. PATENT DOCUMENTS

D234,724 S *	4/1975	Tavel	D24/214
D643,128 S *	8/2011	Mohamed et al.	D24/215
D648,862 S *	11/2011	Yen	D24/215
D681,842 S *	5/2013	Chang	D24/215
D685,105 S *	6/2013	Marshall	D24/215

* cited by examiner

Primary Examiner — Sandra Snapp

(74) *Attorney, Agent, or Firm* — Davis Wright Tremaine LLP; Heather M. Colburn

(57) **CLAIM**

The ornamental design for a personal massager, as shown and described.

DESCRIPTION

FIG. 1 is a right side perspective view of a personal massager showing my new design.

FIG. 2 is a front plan view thereof.

FIG. 3 is a right side plan view thereof.

FIG. 4 is a left side plan view thereof.

FIG. 5 is a rear plan view thereof.

FIG. 6 is a top plan view thereof.

FIG. 7 is a bottom plan view thereof.

FIG. 8 is a right side perspective view of a second embodiment thereof.

FIG. 9 is a front plan view of the second embodiment thereof.

FIG. 10 is a right side plan view of the second embodiment thereof.

FIG. 11 is a left side plan view of the second embodiment thereof.

FIG. 12 is a rear plan view of the second embodiment thereof.

FIG. 13 is a top plan view of the second embodiment thereof; and,

FIG. 14 is a bottom plan view of the second embodiment thereof.

The broken lines represent portions of the personal massager that form no part of the claim.

1 Claim, 12 Drawing Sheets

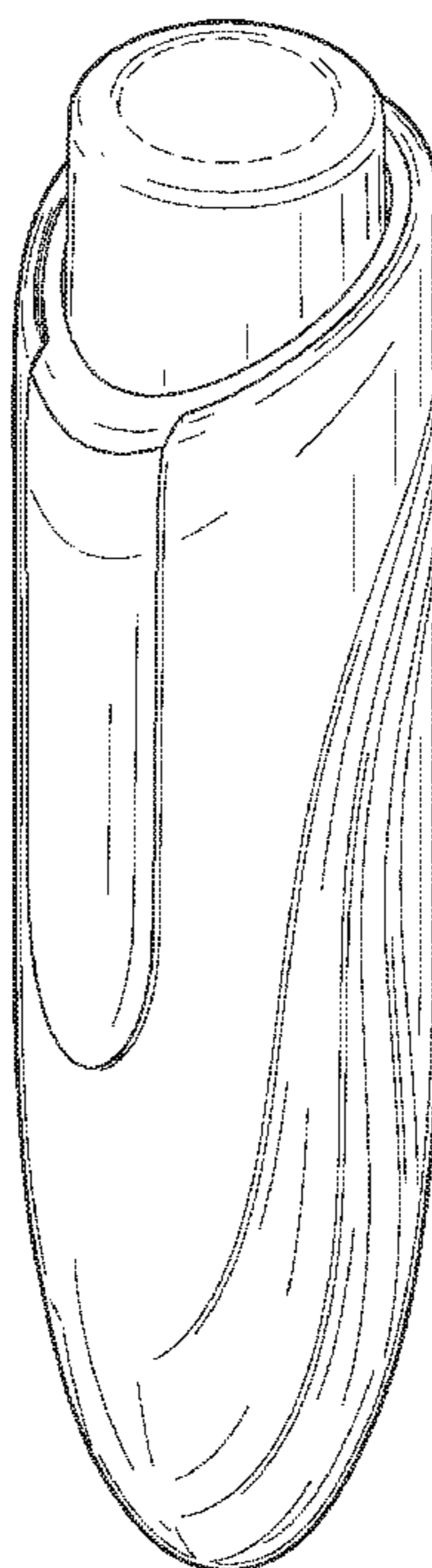

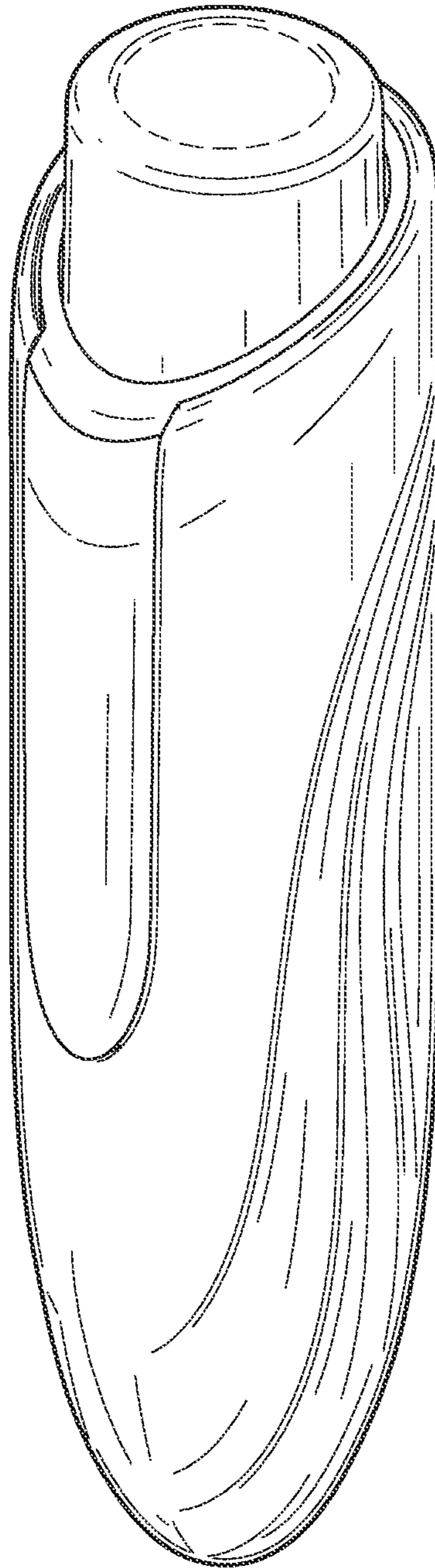

FIG. 1

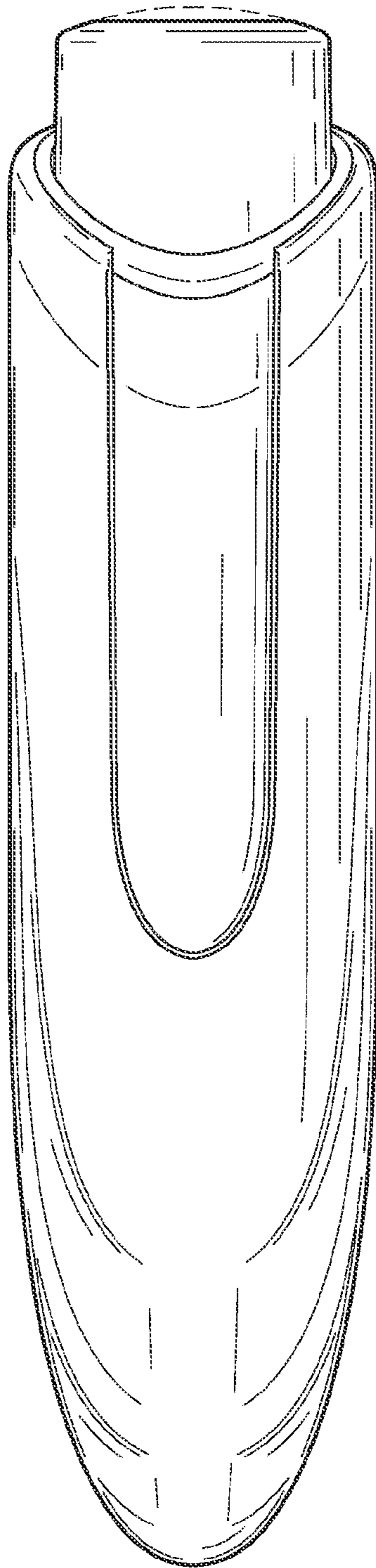

FIG. 2

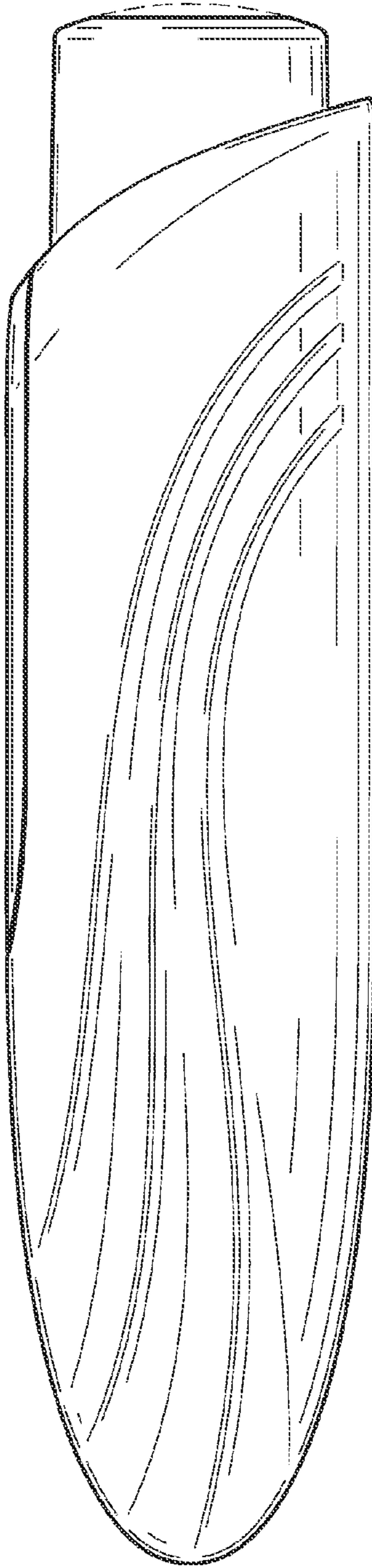

FIG. 3

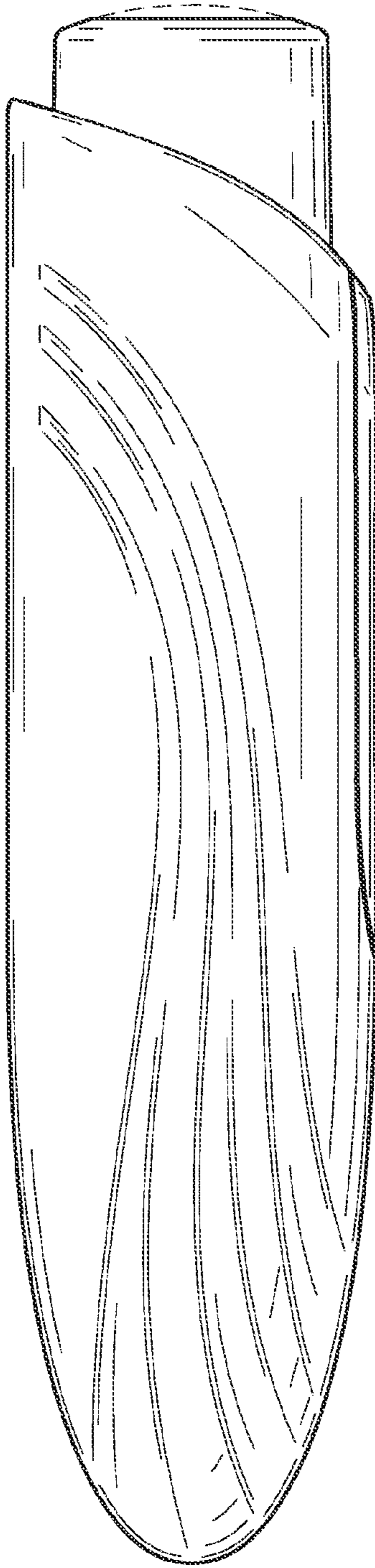

FIG. 4

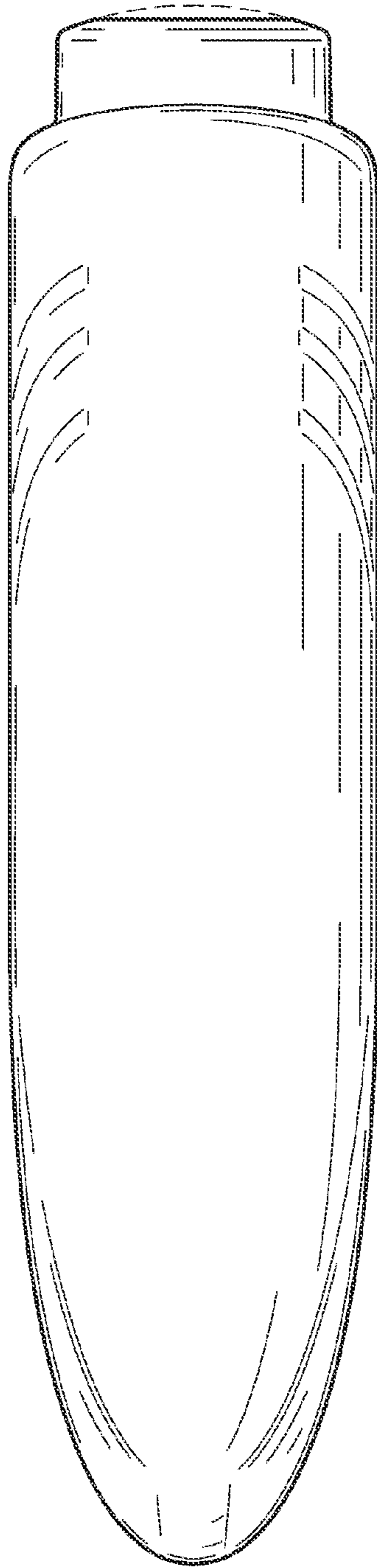

FIG.5

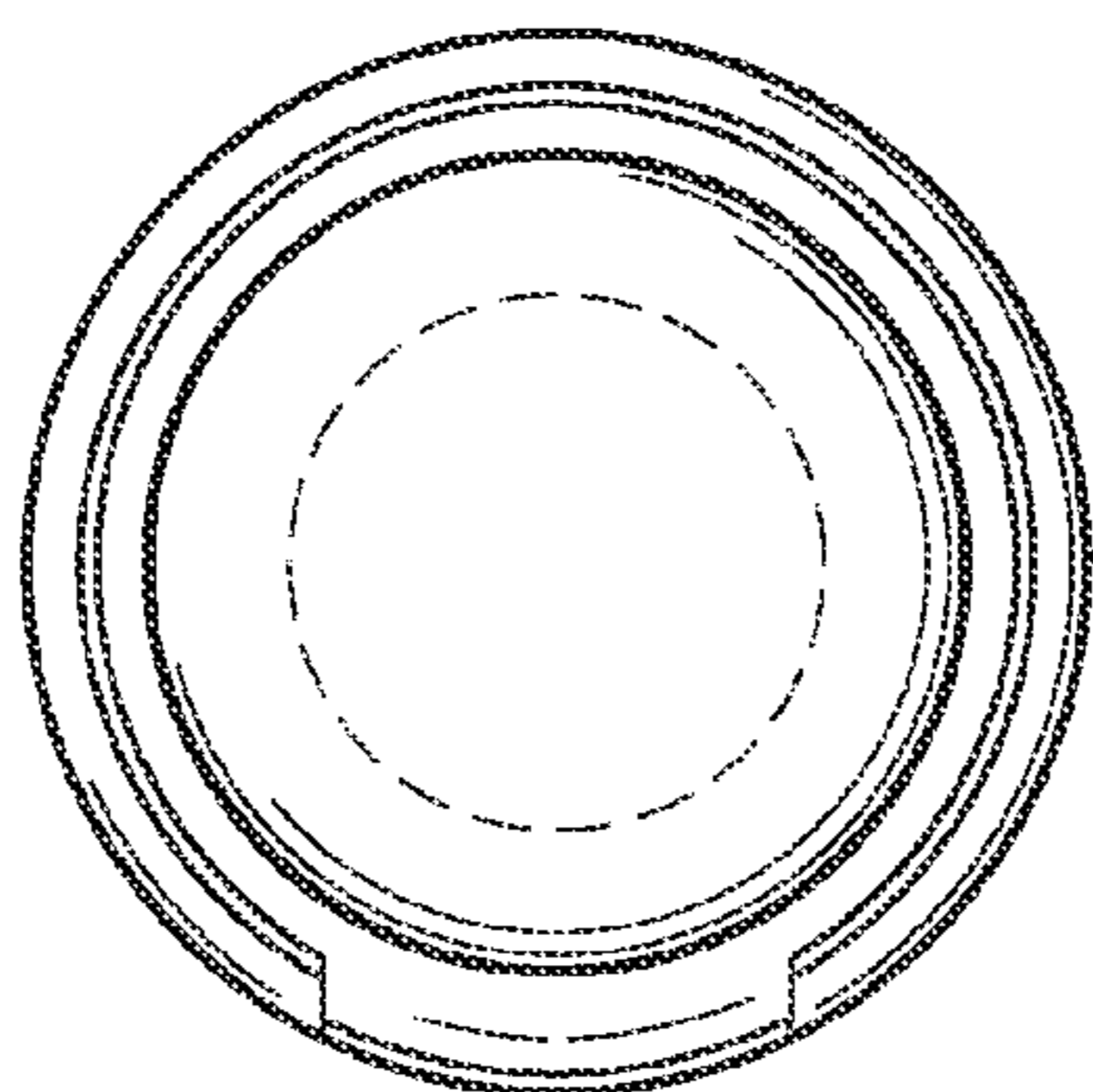

FIG. 6

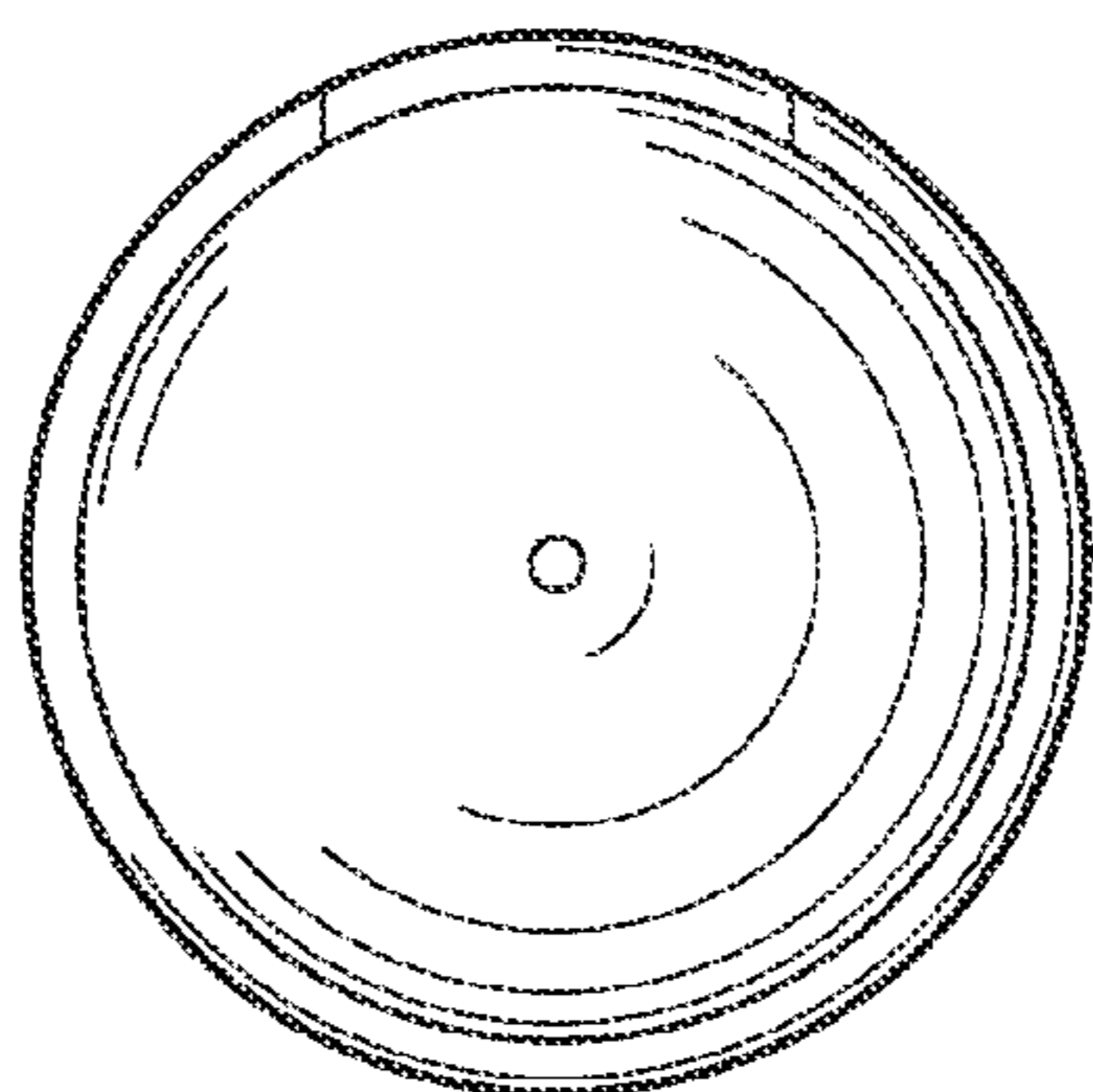

FIG. 7

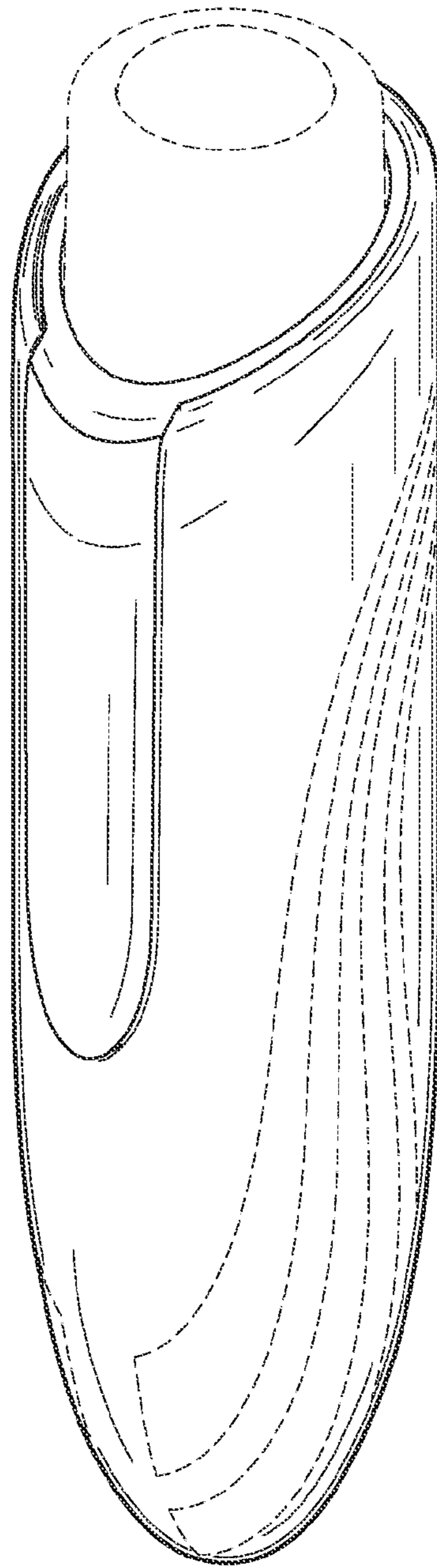

FIG.8

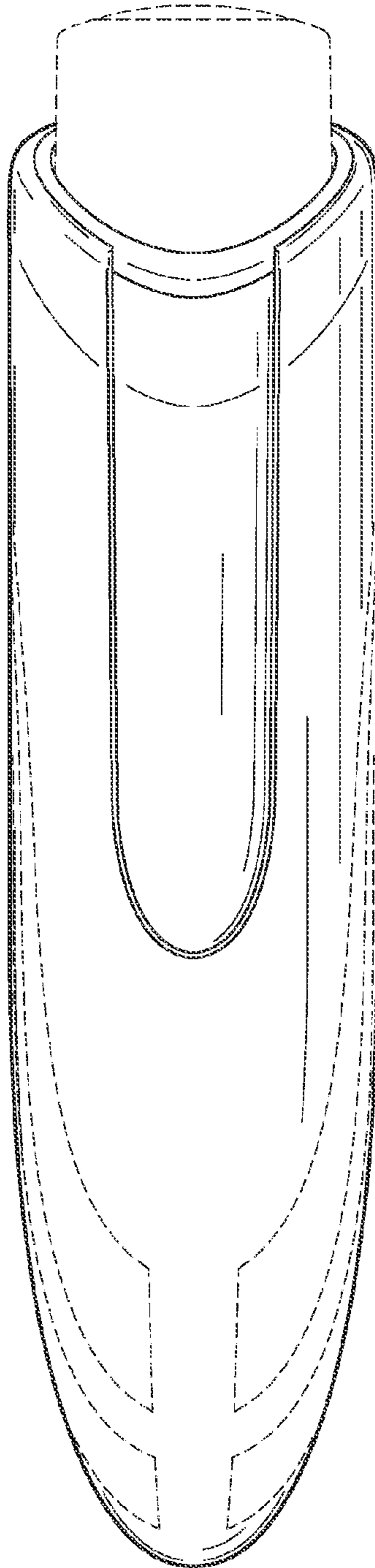

FIG. 9

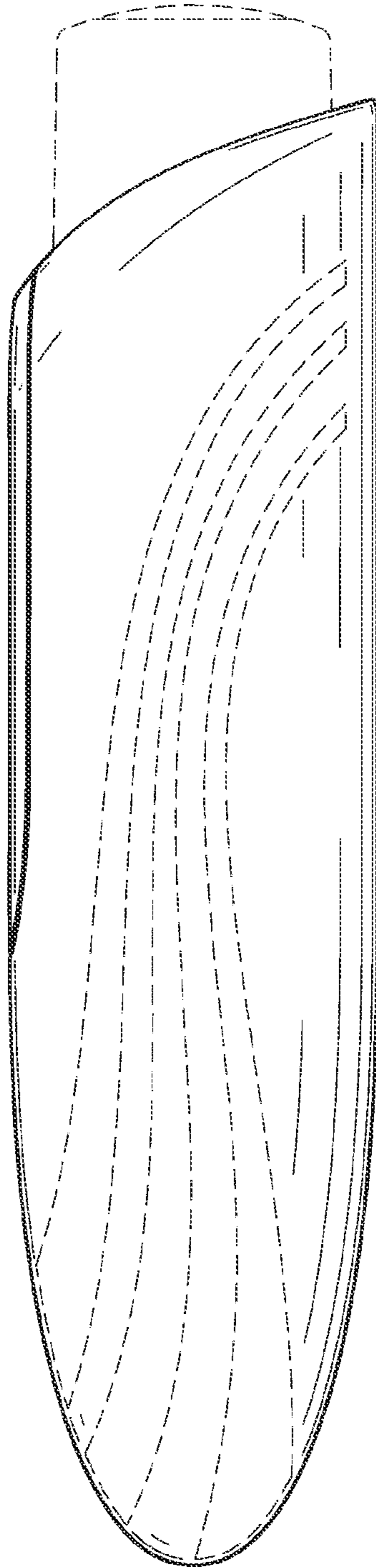

FIG.10

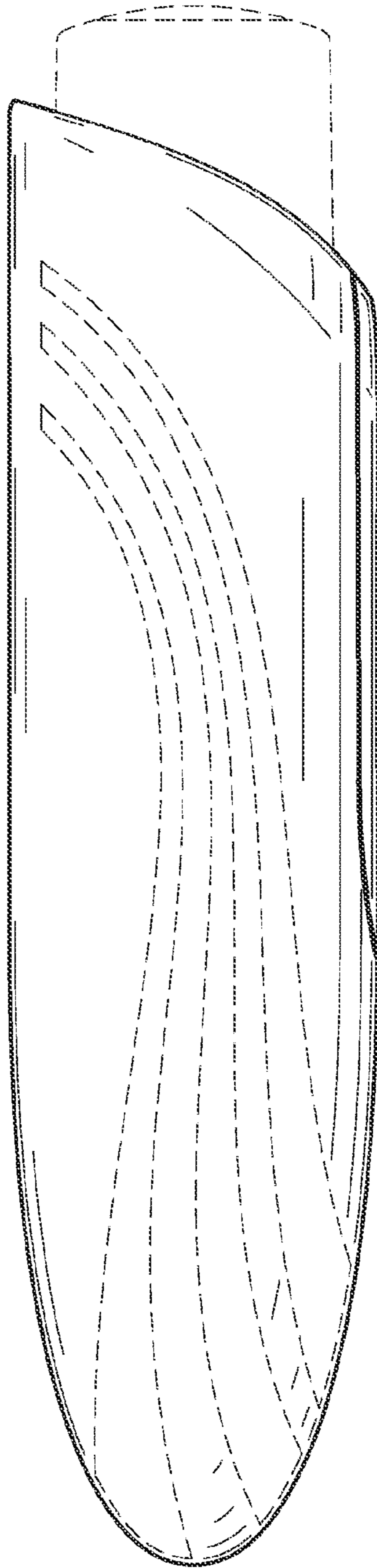

FIG.11

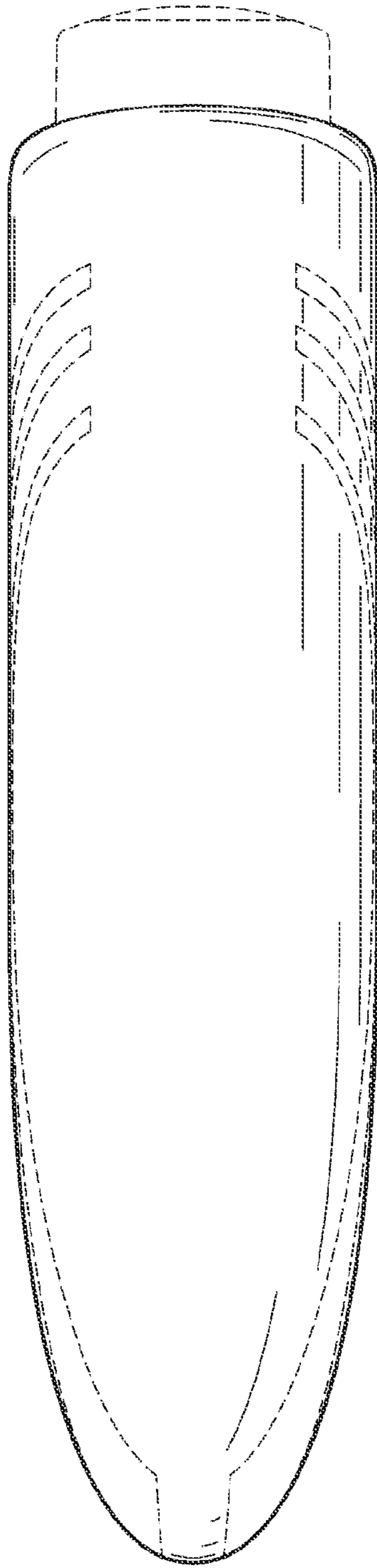

FIG.12

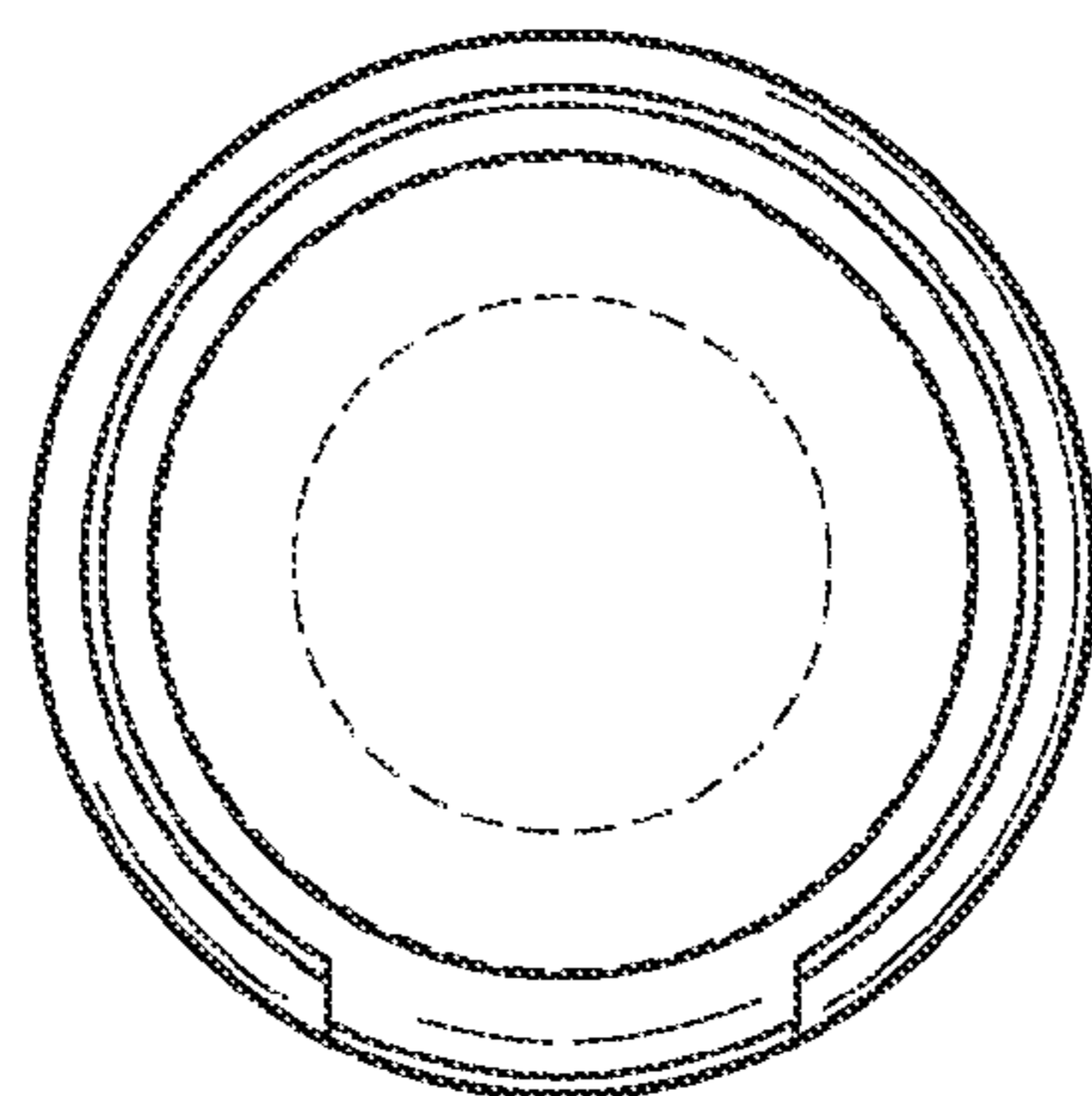

FIG.13

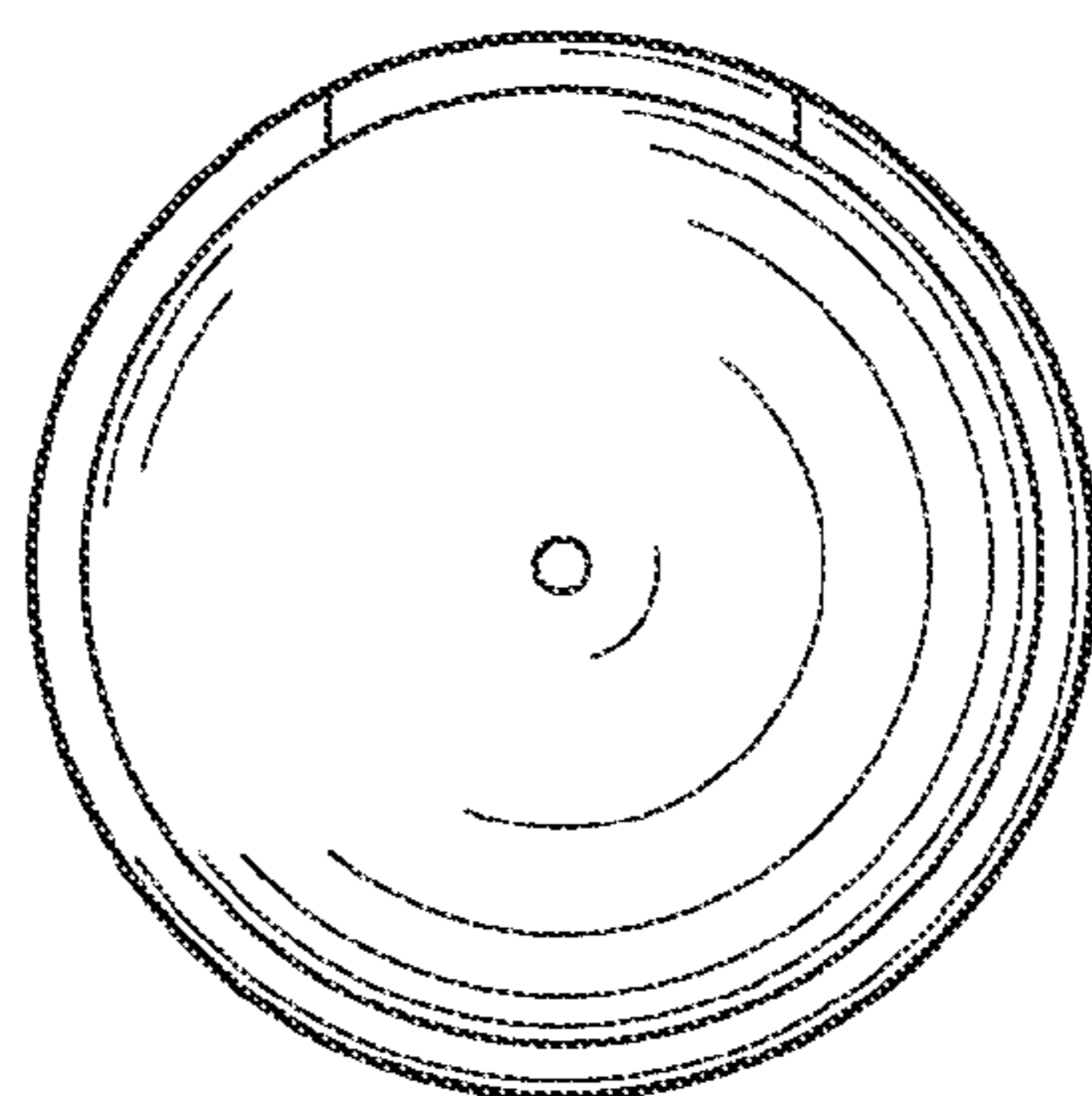

FIG.14