

US00D696383S

(12) **United States Design Patent**
Miller et al.

(10) **Patent No.:** **US D696,383 S**

(45) **Date of Patent:** **** Dec. 24, 2013**

(54) **HANDHELD SHOWER**

(71) Applicant: **Masco Corporation of Indiana,**
Indianapolis, IN (US)

(72) Inventors: **Michael Miller,** Fishers, IN (US);
Robert Zhou, Xiamen (CN)

(73) Assignee: **Masco Corporation of Indiana,**
Indianapolis, IN (US)

(**) Term: **14 Years**

(21) Appl. No.: **29/435,857**

(22) Filed: **Oct. 30, 2012**

(51) **LOC (9) Cl.** **23-01**

(52) **U.S. Cl.**
USPC **D23/223**

(58) **Field of Classification Search**
USPC D23/213, 223, 229, 230; 239/282, 283,
239/556

See application file for complete search history.

(56) **References Cited**

U.S. PATENT DOCUMENTS

D610,228 S * 2/2010 Wu et al. D23/223
D610,229 S * 2/2010 Wu et al. D23/223

D654,983 S * 2/2012 Schoenherr et al. D23/223
D654,984 S * 2/2012 Schoenherr et al. D23/223
D672,011 S * 12/2012 Andrew et al. D23/223
D672,432 S * 12/2012 Spangler D23/213
D681,776 S * 5/2013 Cutler et al. D23/223

* cited by examiner

Primary Examiner — Robin V Webster

(74) *Attorney, Agent, or Firm* — Edgar A. Zarins

(57) **CLAIM**

The ornamental design for a handheld shower, as shown and described.

DESCRIPTION

FIG. 1 is a perspective view of a handheld shower showing our new design;
FIG. 2 is a rear perspective view thereof;
FIG. 3 is a right side view thereof;
FIG. 4 is a front view thereof;
FIG. 5 is a left side view thereof;
FIG. 6 is a rear view thereof;
FIG. 7 is a top end view thereof; and,
FIG. 8 is a bottom end view thereof.
The broken line showing is included for the purpose of illustrating and forms no part of the claimed design.

1 Claim, 3 Drawing Sheets

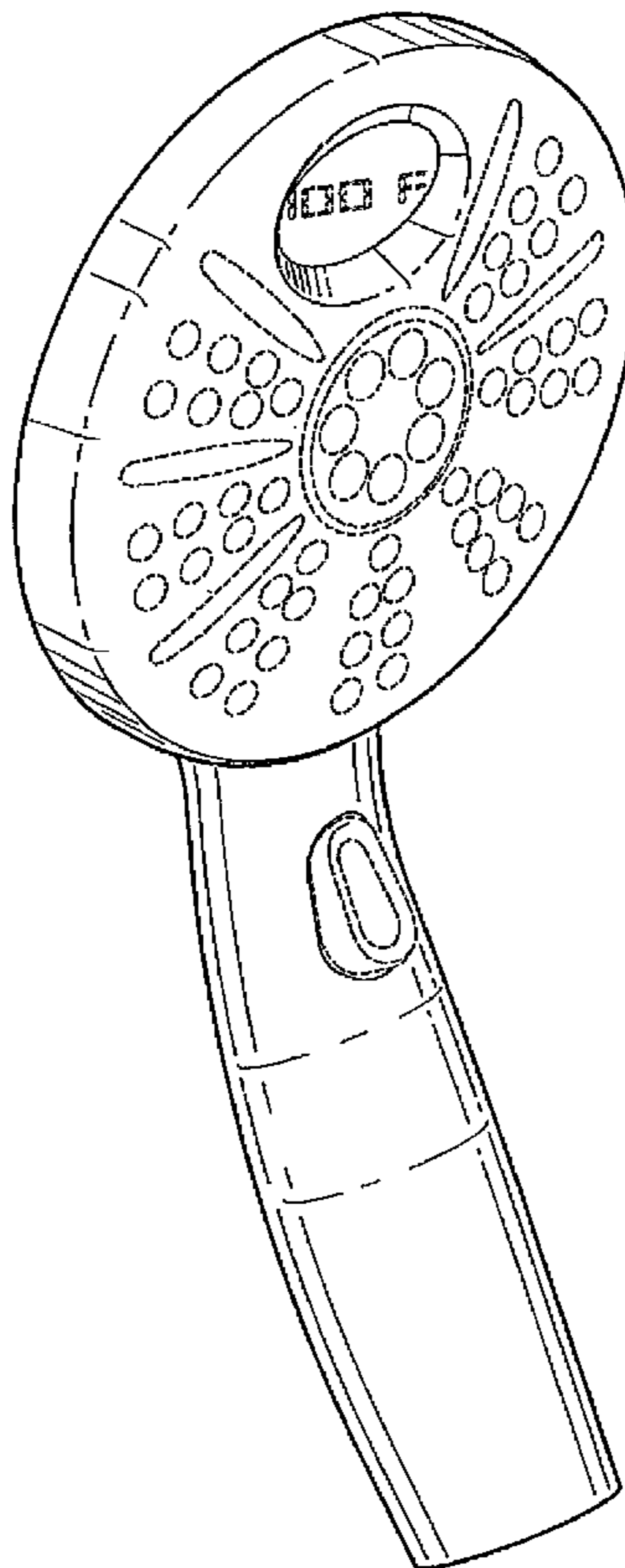

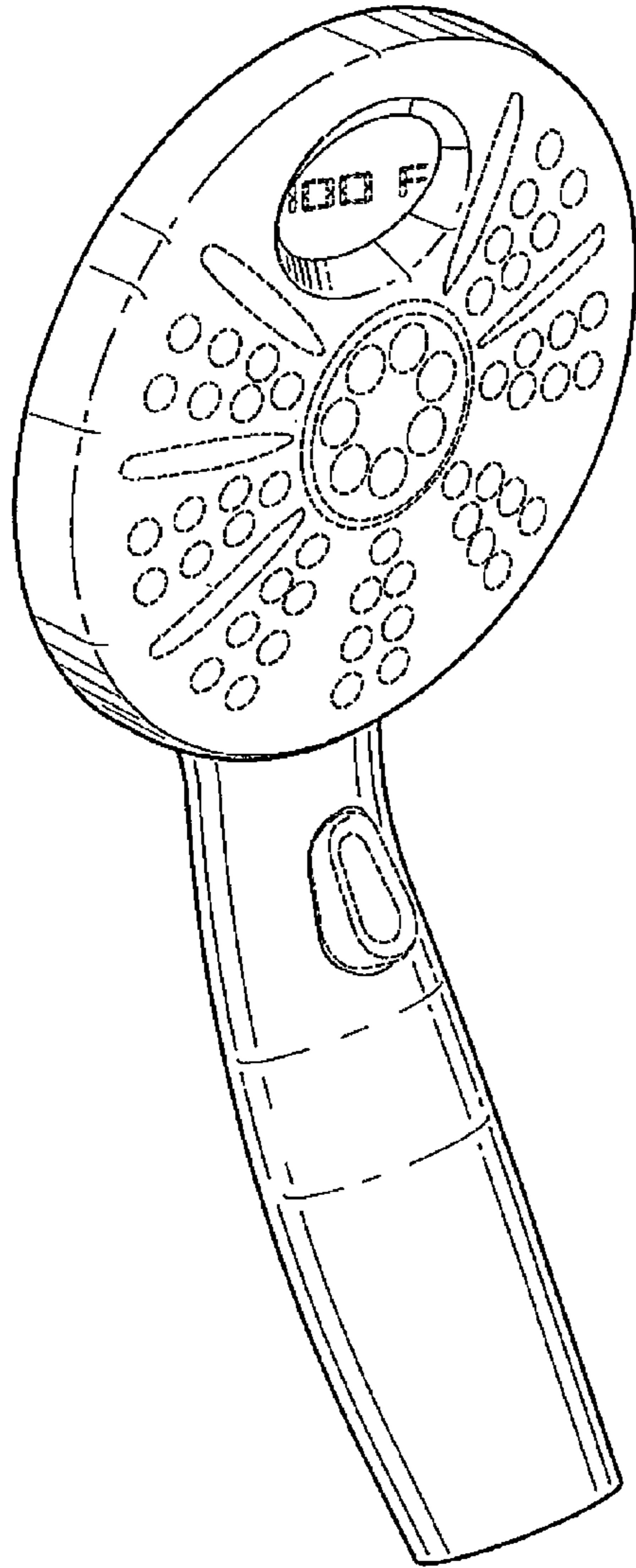

Fig-1

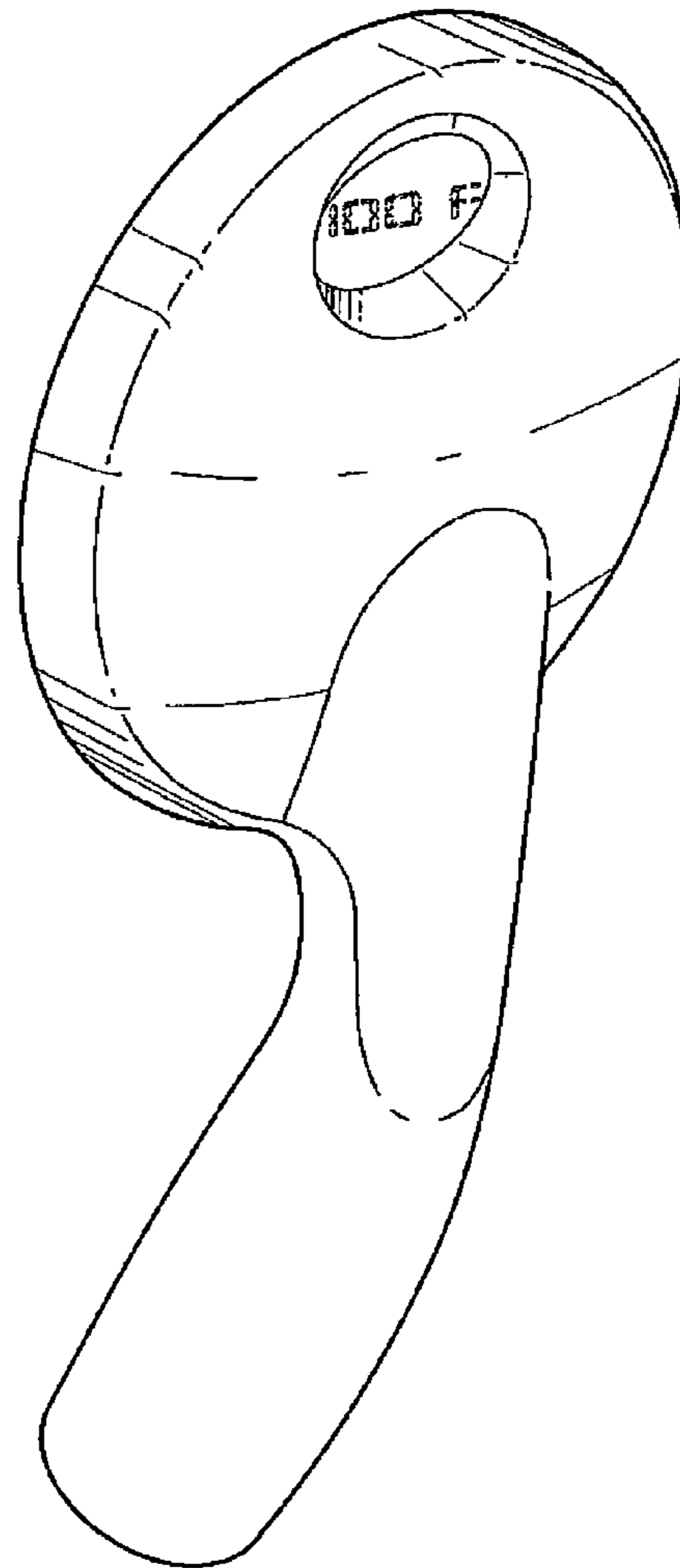

Fig-2

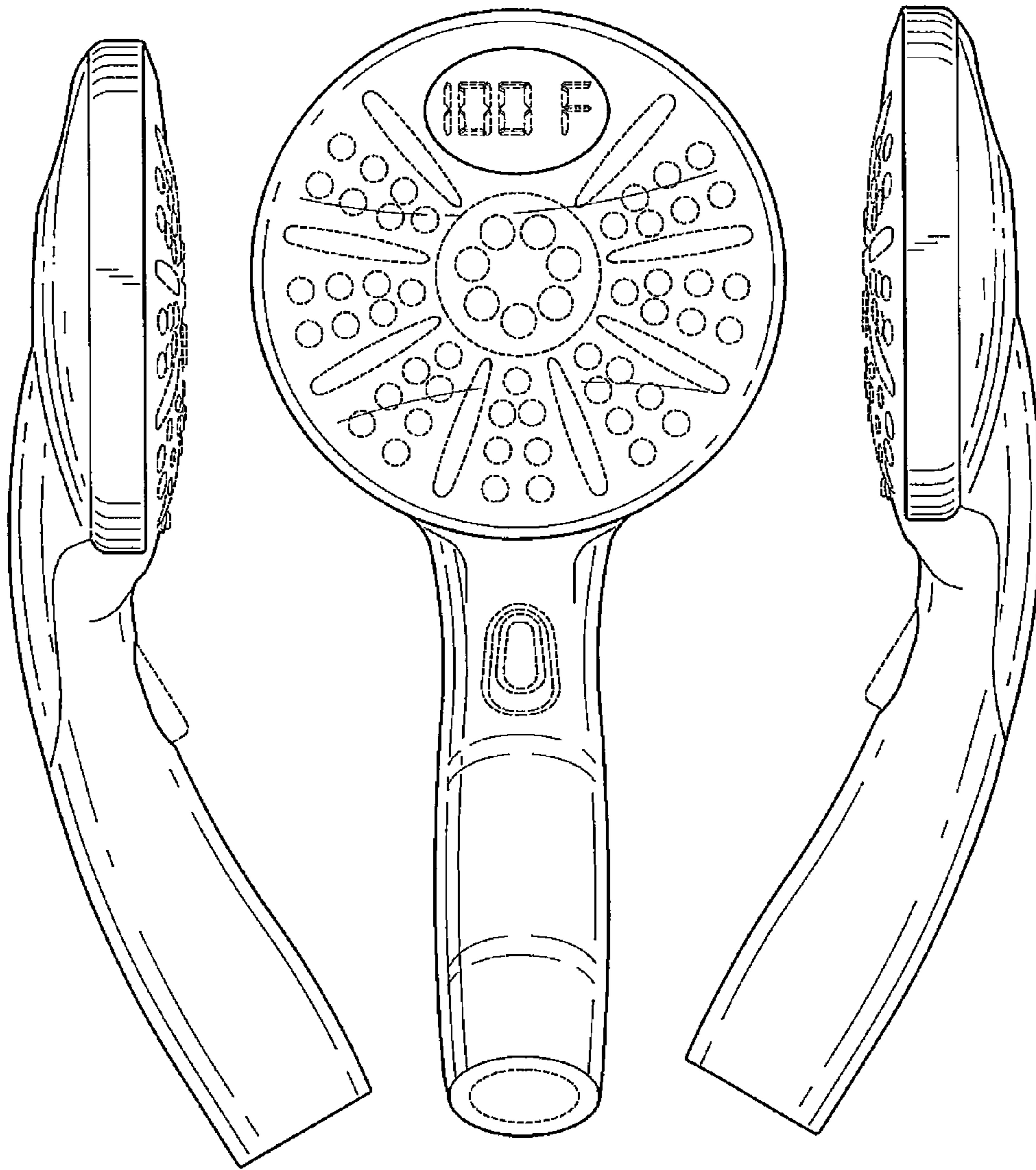

Fig-3

Fig-4

Fig-5

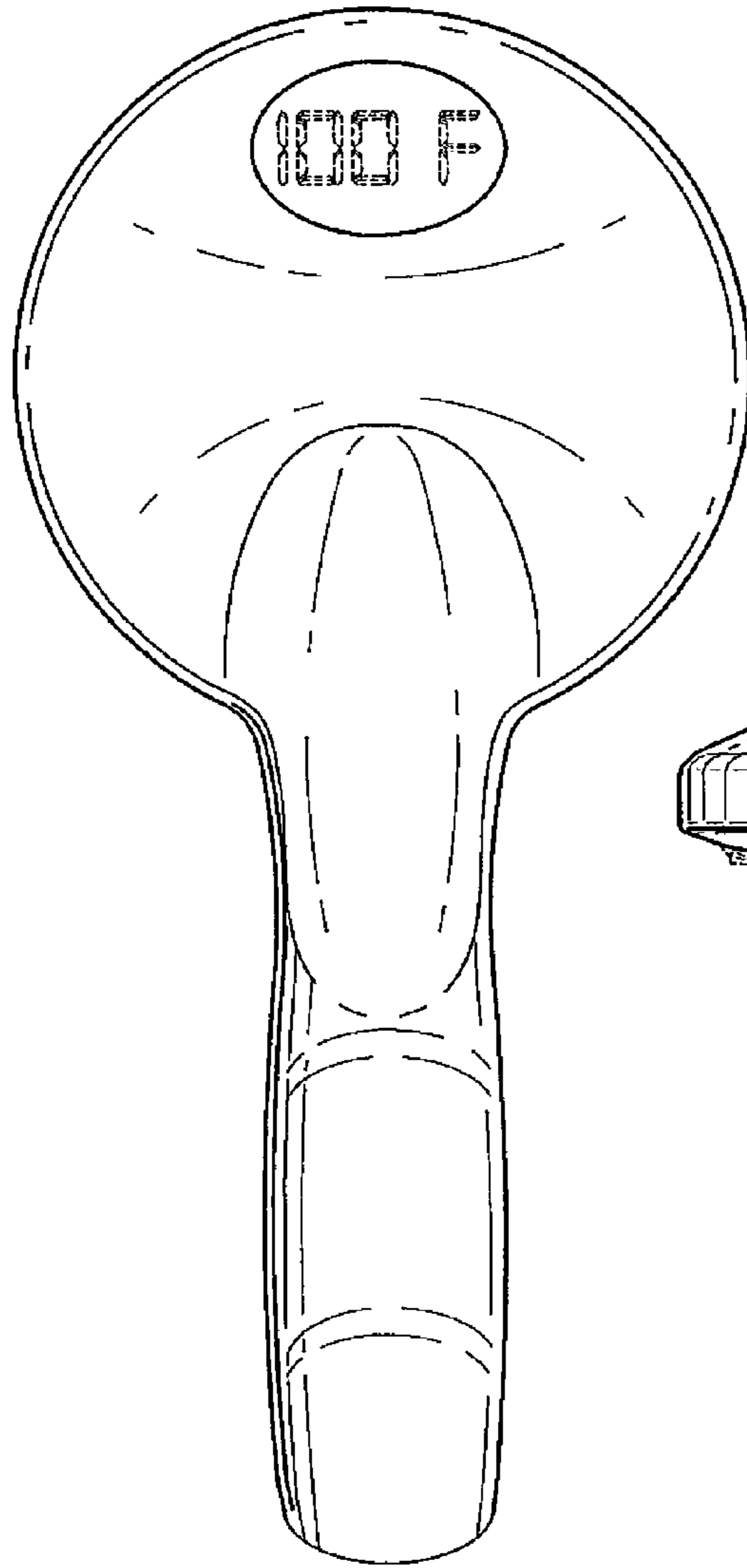

Fig-6

Fig-7

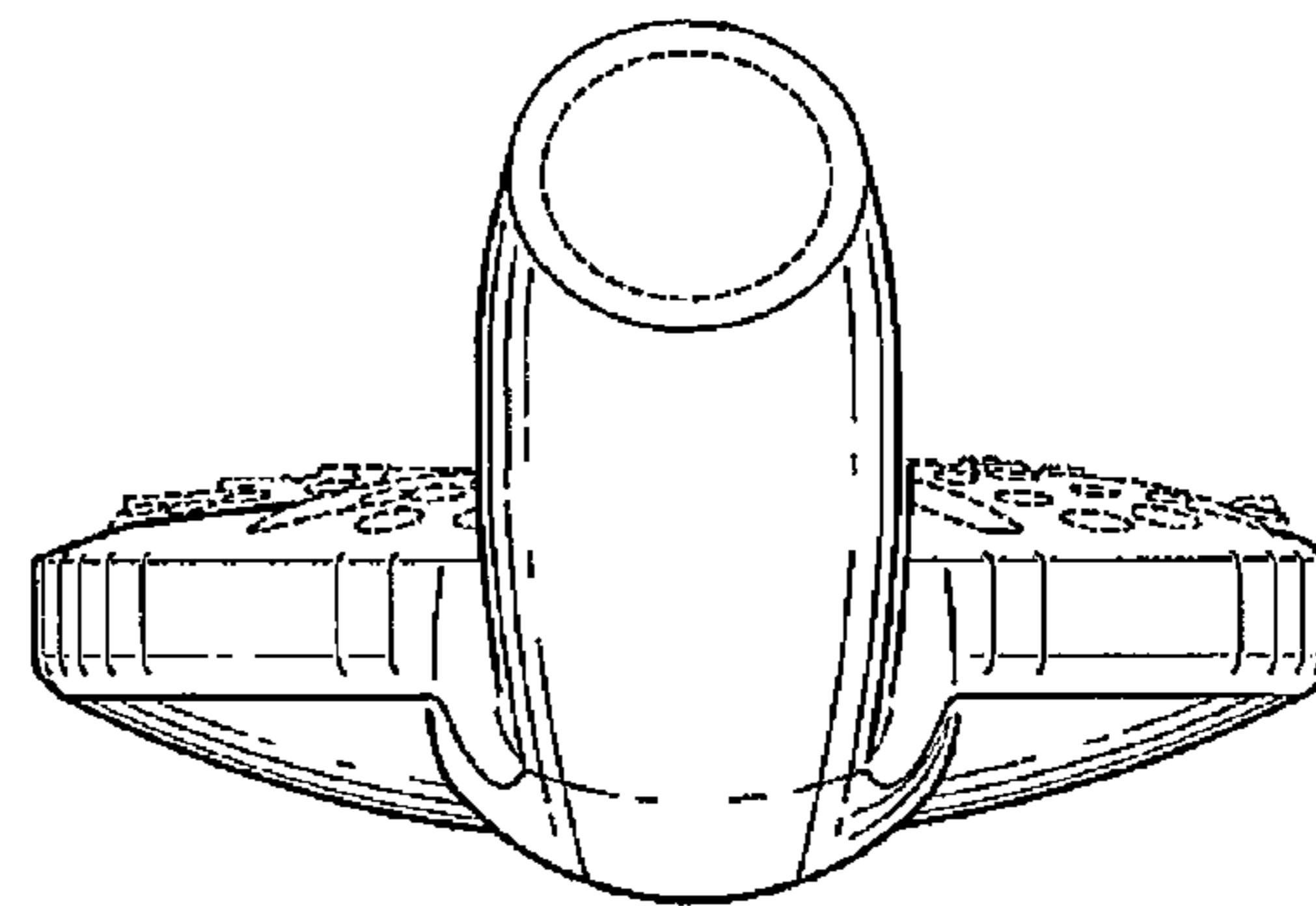
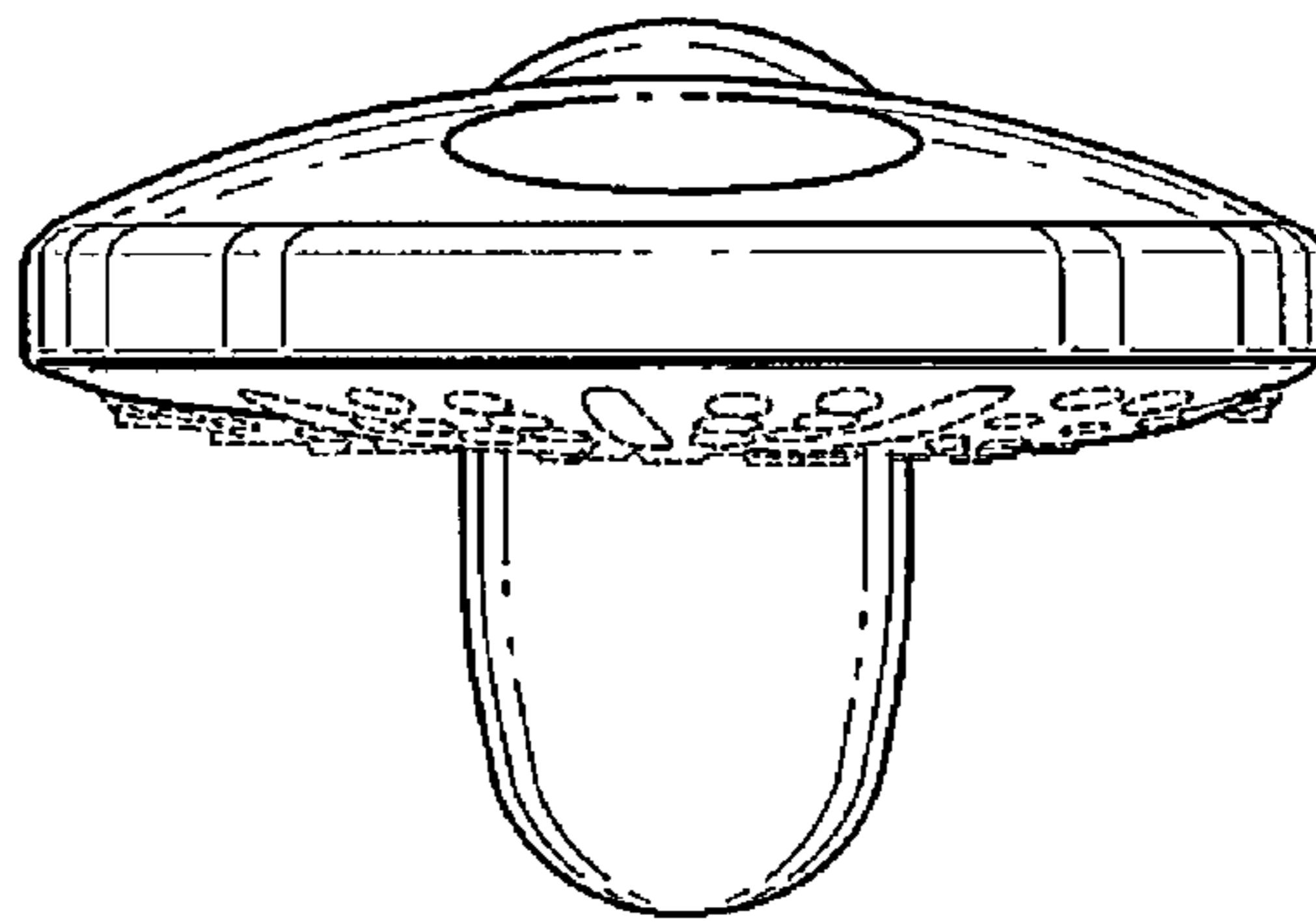

Fig-8