



US00D696366S

(12) **United States Design Patent**
Milo et al.

(10) **Patent No.:** **US D696,366 S**
(45) **Date of Patent:** **** Dec. 24, 2013**

(54) **GOLF CLUB HEAD**

FOREIGN PATENT DOCUMENTS

- (71) Applicant: **Taylor Made Golf Company, Inc.**,
Carlsbad, CA (US)
- (72) Inventors: **Maresala Milo**, San Diego, CA (US);
Joshua J. Dipert, Carlsbad, CA (US);
Scott Taylor, Bonita, CA (US); **Robert**
Nunez, Vista, CA (US)
- (73) Assignee: **Taylor Made Golf Company, Inc.**,
Carlsbad, CA (US)
- (**) Term: **14 Years**
- (21) Appl. No.: **29/435,375**
- (22) Filed: **Oct. 23, 2012**
- (51) **LOC (9) Cl.** **21-02**
- (52) **U.S. Cl.**
USPC **D21/747**
- (58) **Field of Classification Search**
USPC D21/747-751, 759; 473/324-331, 350,
473/304-305, 314
See application file for complete search history.

JP 2004-351173 12/2004
Primary Examiner — Mitchell Siegel
 (74) *Attorney, Agent, or Firm* — Klarquist Sparkman, LLP

(57) **CLAIM**
 We claim the ornamental design for a golf club head, as shown and described.

DESCRIPTION

FIG. 1 is a perspective view of a golf club head, as viewed from the rear, bottom and heel side, according to one embodiment.
 FIG. 2 is a front elevation view of the golf club head of FIG. 1.
 FIG. 3 is a rear elevation view of the golf club head of FIG. 1.
 FIG. 4 is a side elevation view of the toe of the golf club head of FIG. 1.
 FIG. 5 is a side elevation view of the heel of the golf club head of FIG. 1.
 FIG. 6 is a top plan view of the golf club head of FIG. 1.
 FIG. 7 is a bottom plan view of the golf club head of FIG. 1.
 FIG. 8 is a perspective view of a golf club head, as viewed from the rear, bottom and heel side, according to a second embodiment.
 FIG. 9 is a front elevation view of the golf club head of FIG. 8.
 FIG. 10 is a rear elevation view of the golf club head of FIG. 8.
 FIG. 11 is a side elevation view of the toe of the golf club head of FIG. 8.
 FIG. 12 is a side elevation view of the heel of the golf club head of FIG. 8.
 FIG. 13 is a top plan view of the golf club head of FIG. 8; and, FIG. 14 is a bottom plan view of the golf club head of FIG. 1.
 The dashed lines in the drawings are for illustrative purposes only and form no part of the claimed design.

(56) **References Cited**

U.S. PATENT DOCUMENTS

1,983,158 A	12/1934	Young
2,067,556 A	1/1937	Wettlaufer
2,363,991 A	11/1944	Reach
3,191,936 A	6/1965	Guier
3,909,005 A	9/1975	Pizsel
4,512,577 A	4/1985	Solheim
4,948,132 A	8/1990	Wharton
4,995,609 A	2/1991	Parente et al.
5,165,688 A	11/1992	Schmidt et al.

(Continued)

1 Claim, 8 Drawing Sheets

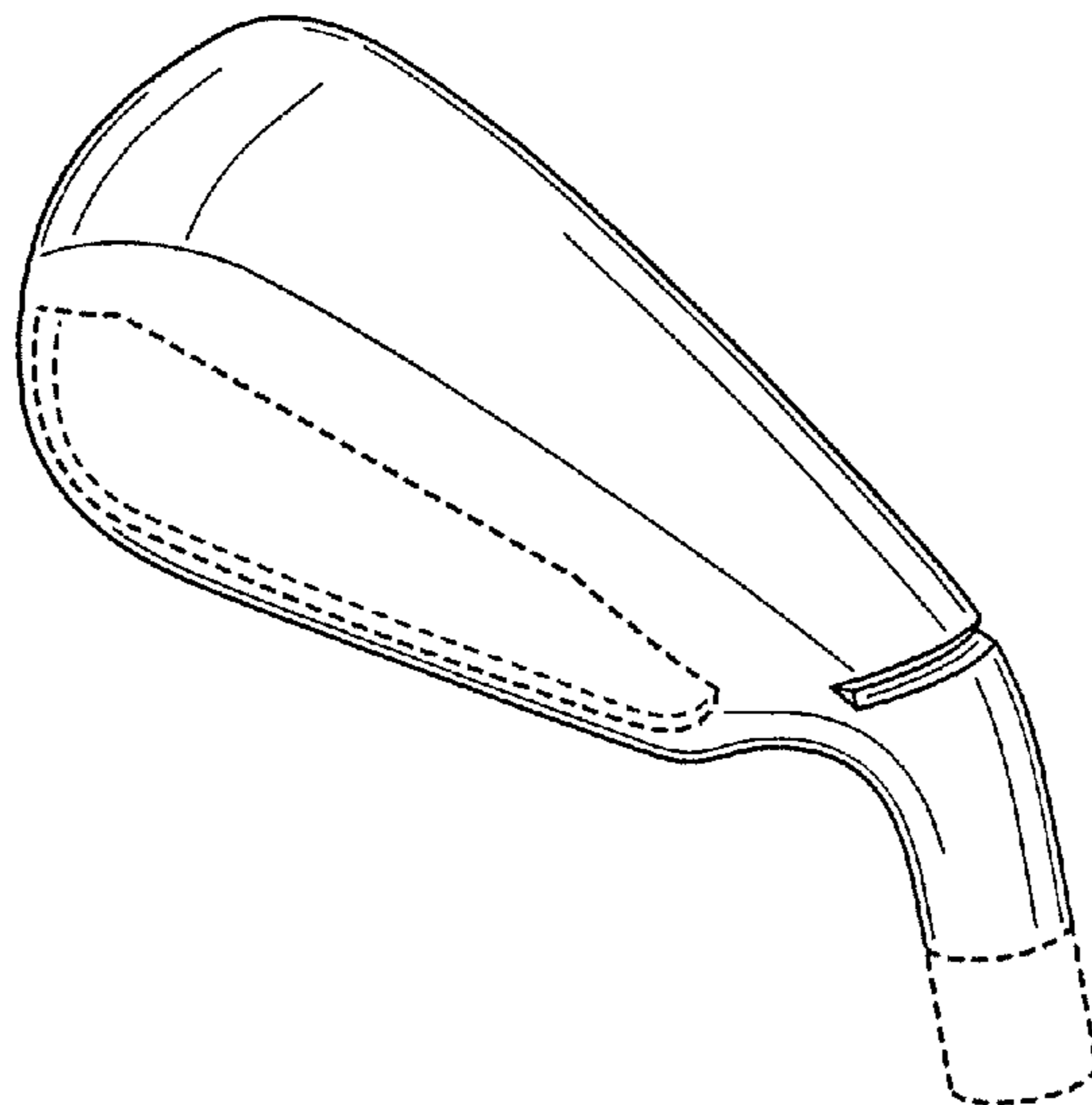

(56)

References Cited

U.S. PATENT DOCUMENTS

5,230,510 A	7/1993	Duclos		5,626,528 A	5/1997	Toulon	
D339,397 S *	9/1993	Iinuma	D21/750	5,647,807 A	7/1997	Nagamoto	
5,275,408 A	1/1994	Desbiolles et al.		5,873,790 A	2/1999	Yeh	
D345,775 S *	4/1994	Poincenot et al.	D21/750	6,186,903 B1	2/2001	Beebe et al.	
5,395,109 A	3/1995	Fenton, Jr.		6,206,790 B1	3/2001	Kubica et al.	
5,584,770 A	12/1996	Jensen		6,287,215 B1	9/2001	Fisher	
5,586,944 A	12/1996	Nagamoto et al.		D526,038 S *	8/2006	Kelley	D21/759
5,601,498 A	2/1997	Antonious		D589,107 S *	3/2009	Oldknow	D21/759
				2005/0009632 A1	1/2005	Schweigert et al.	
				2008/0102977 A1 *	5/2008	Huang et al.	473/314
				2010/0279787 A1	11/2010	Stites et al.	

* cited by examiner

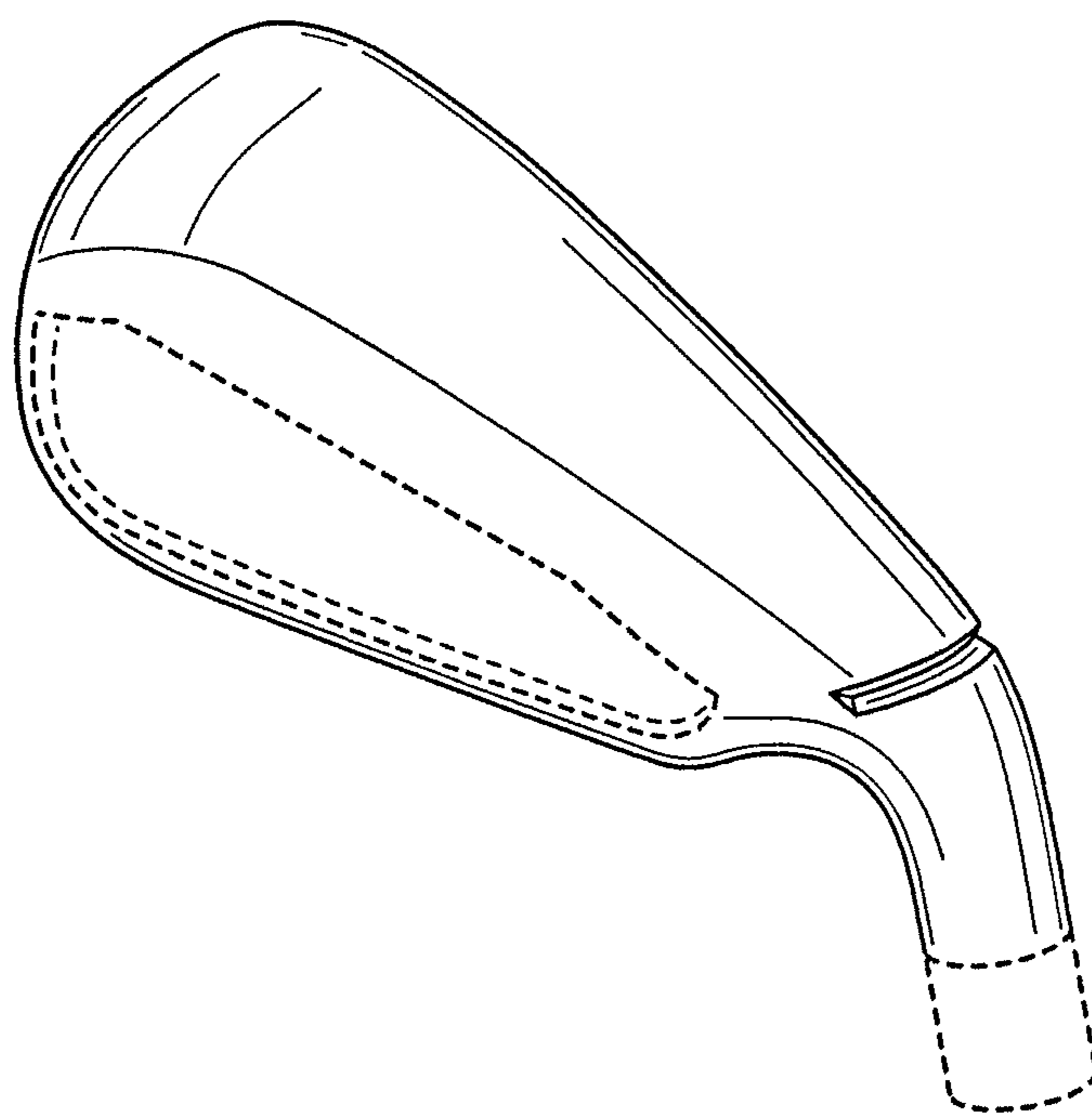

FIG. 1

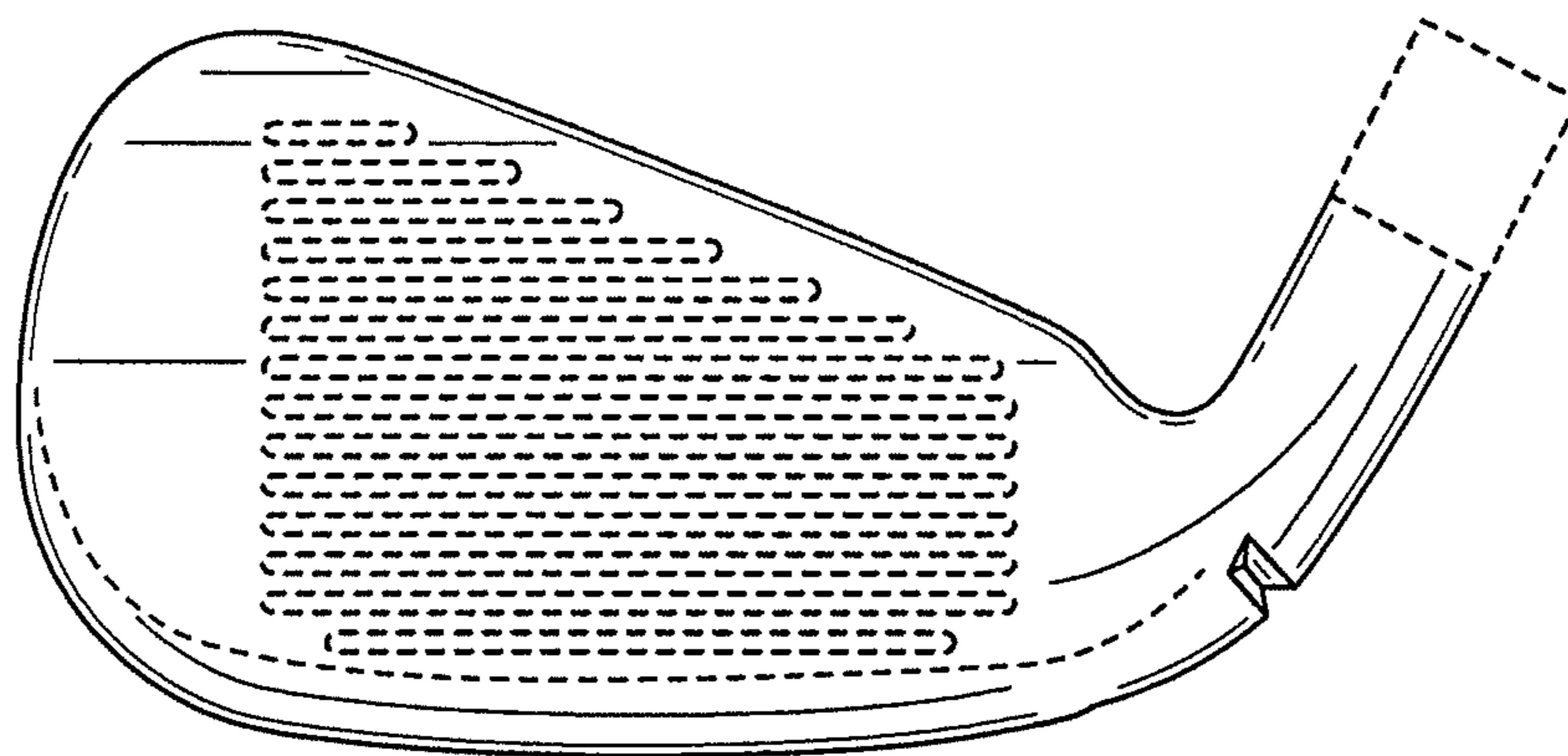

FIG. 2

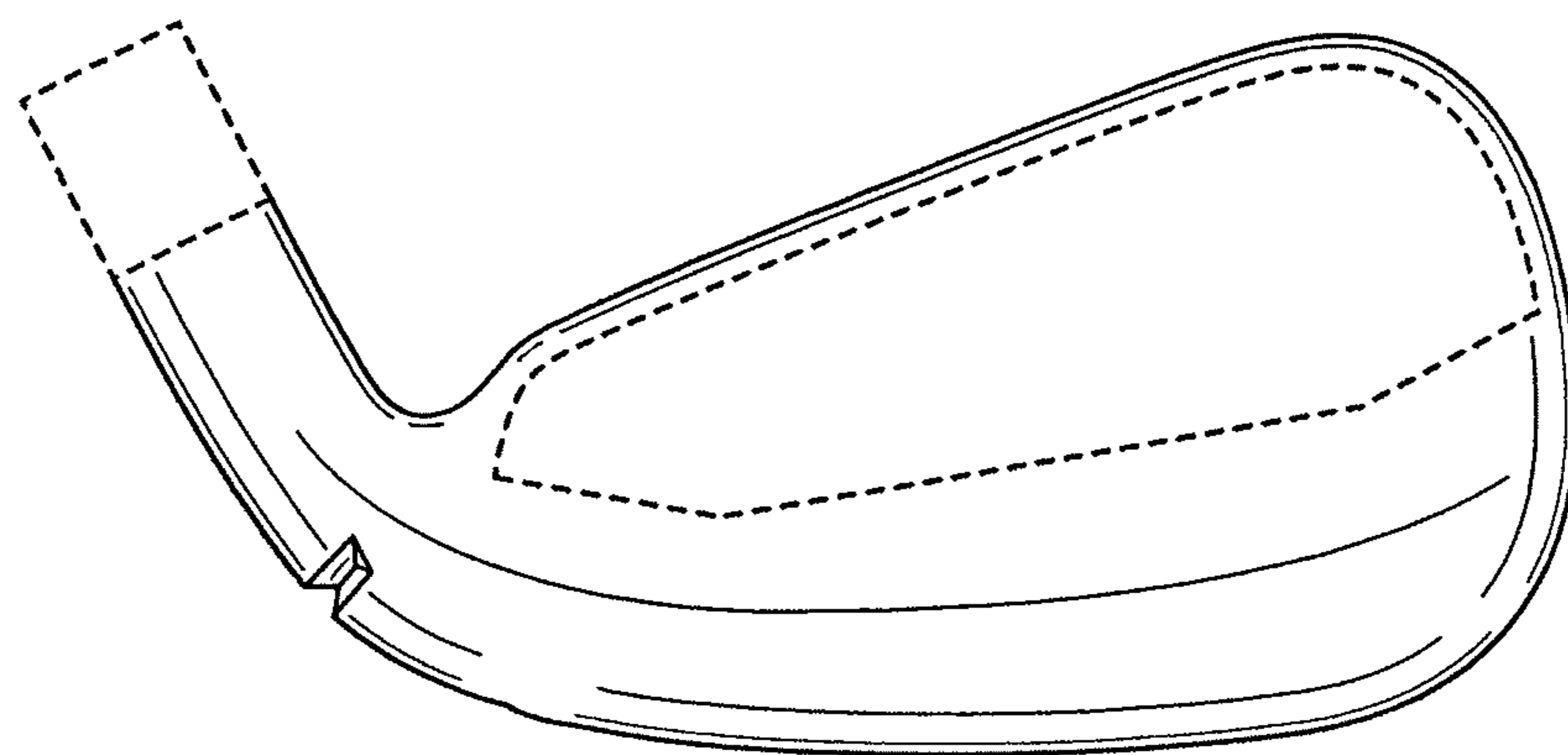

FIG. 3

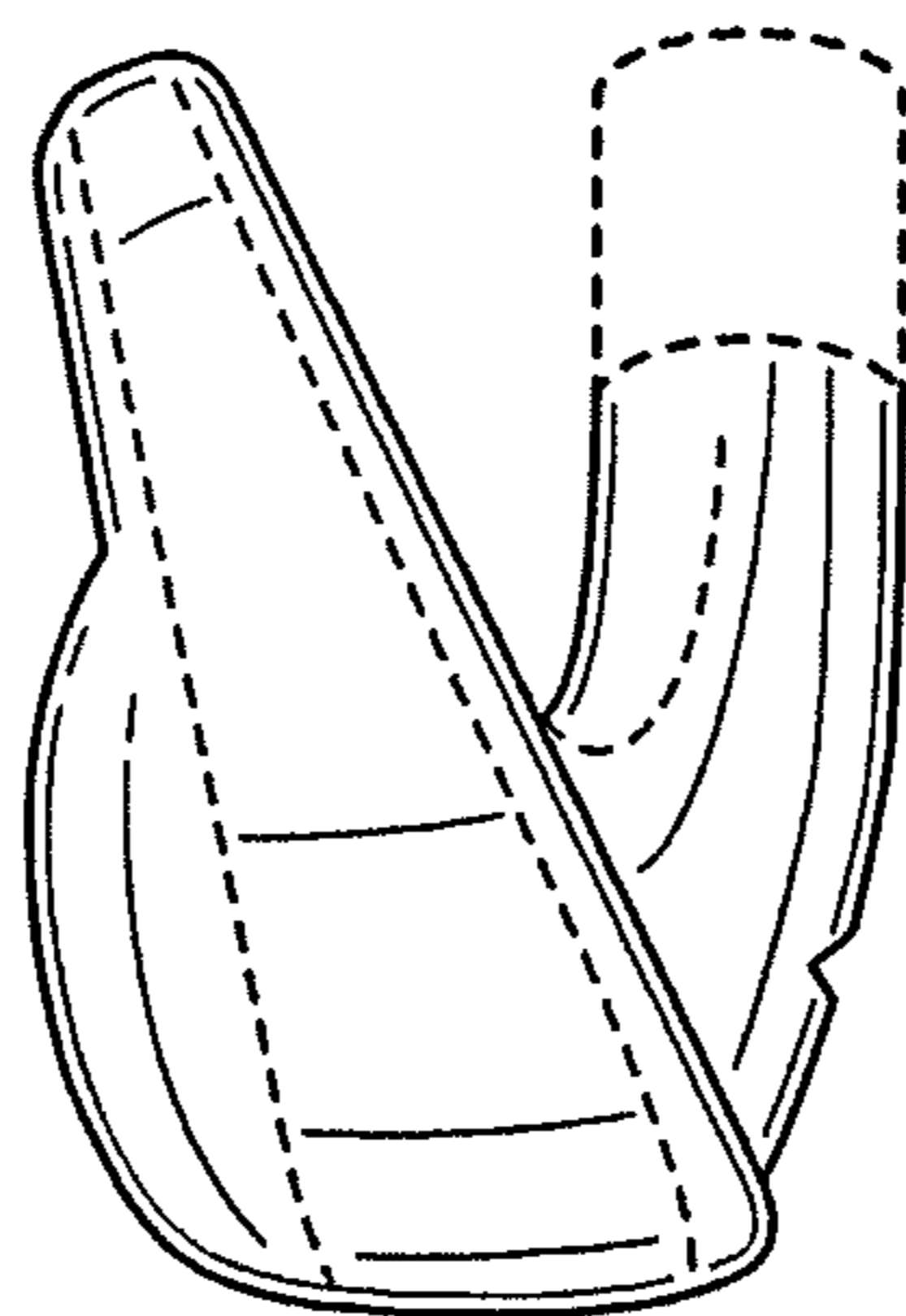

FIG. 4

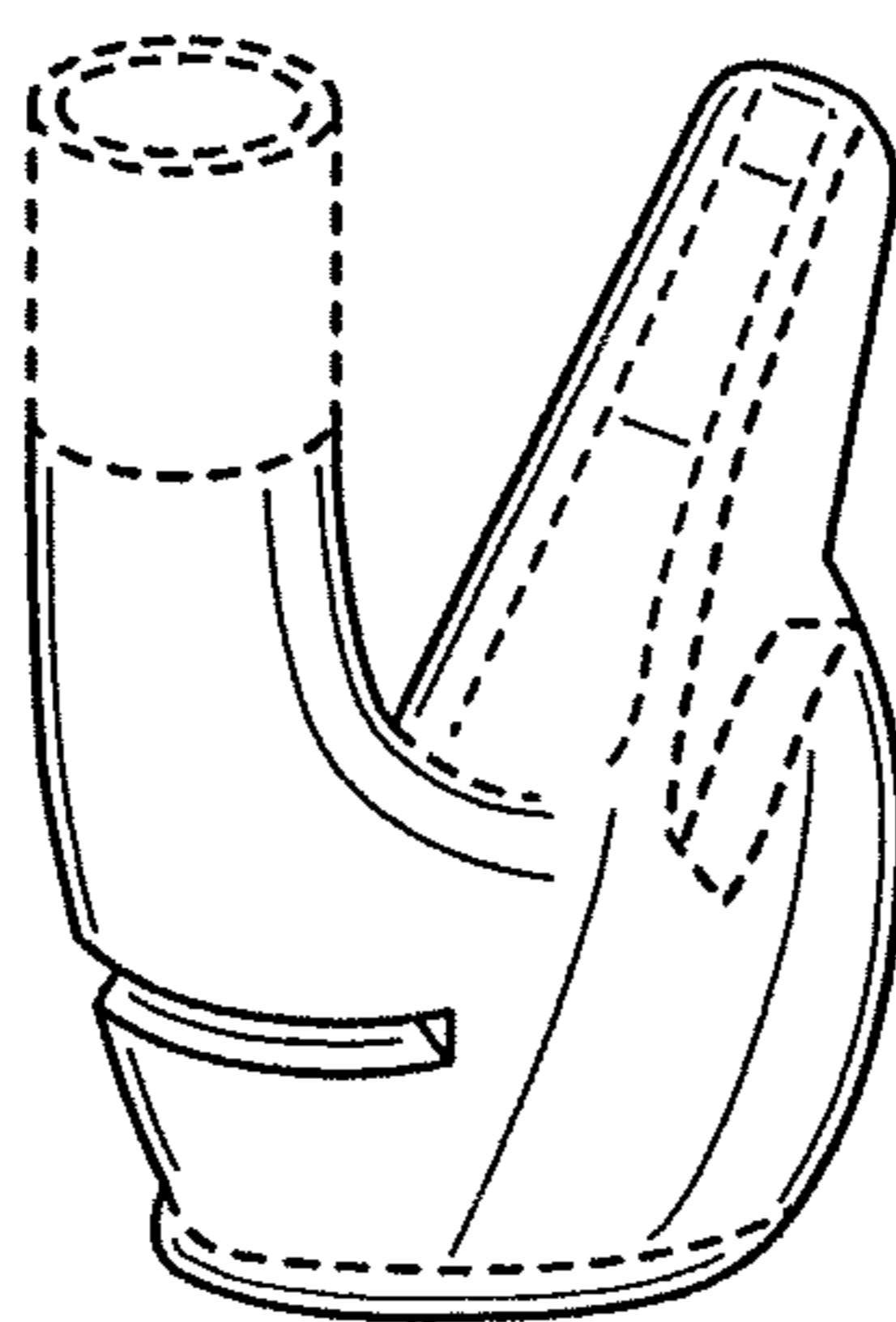

FIG. 5

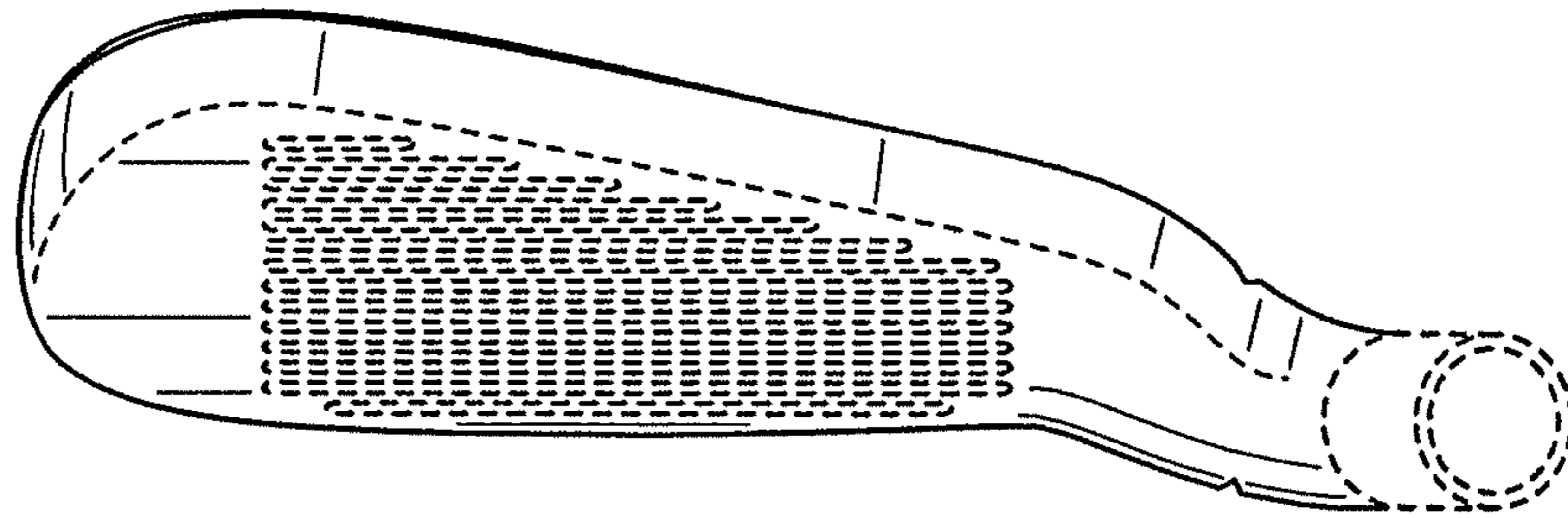

FIG. 6

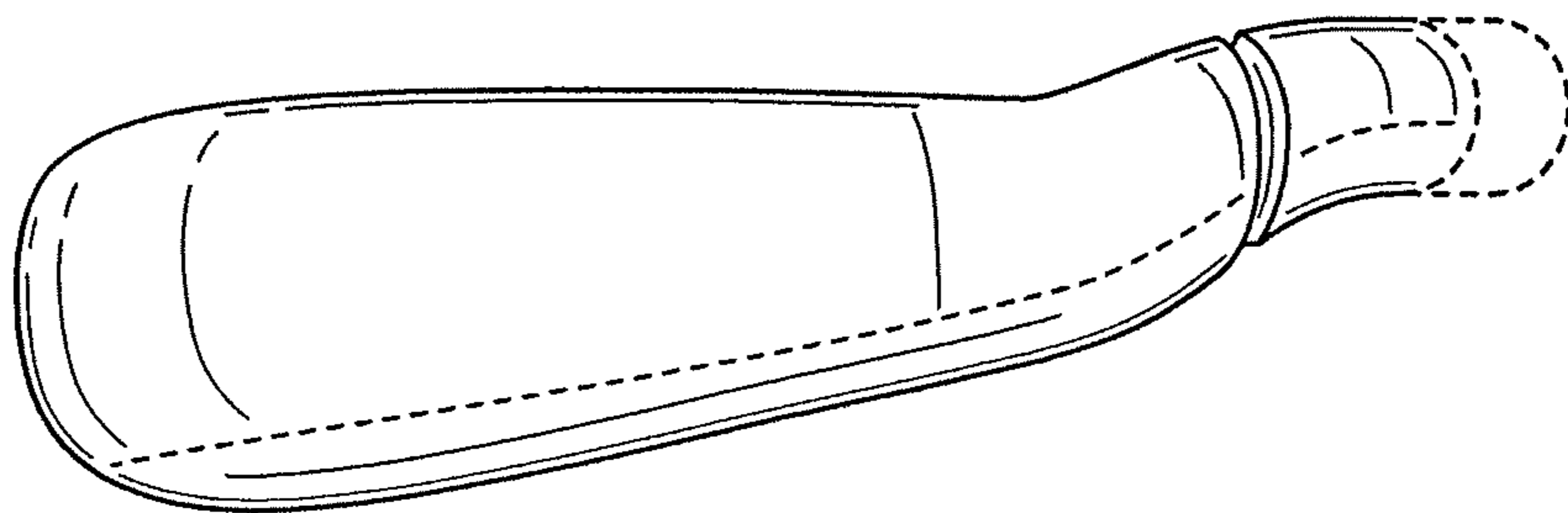

FIG. 7

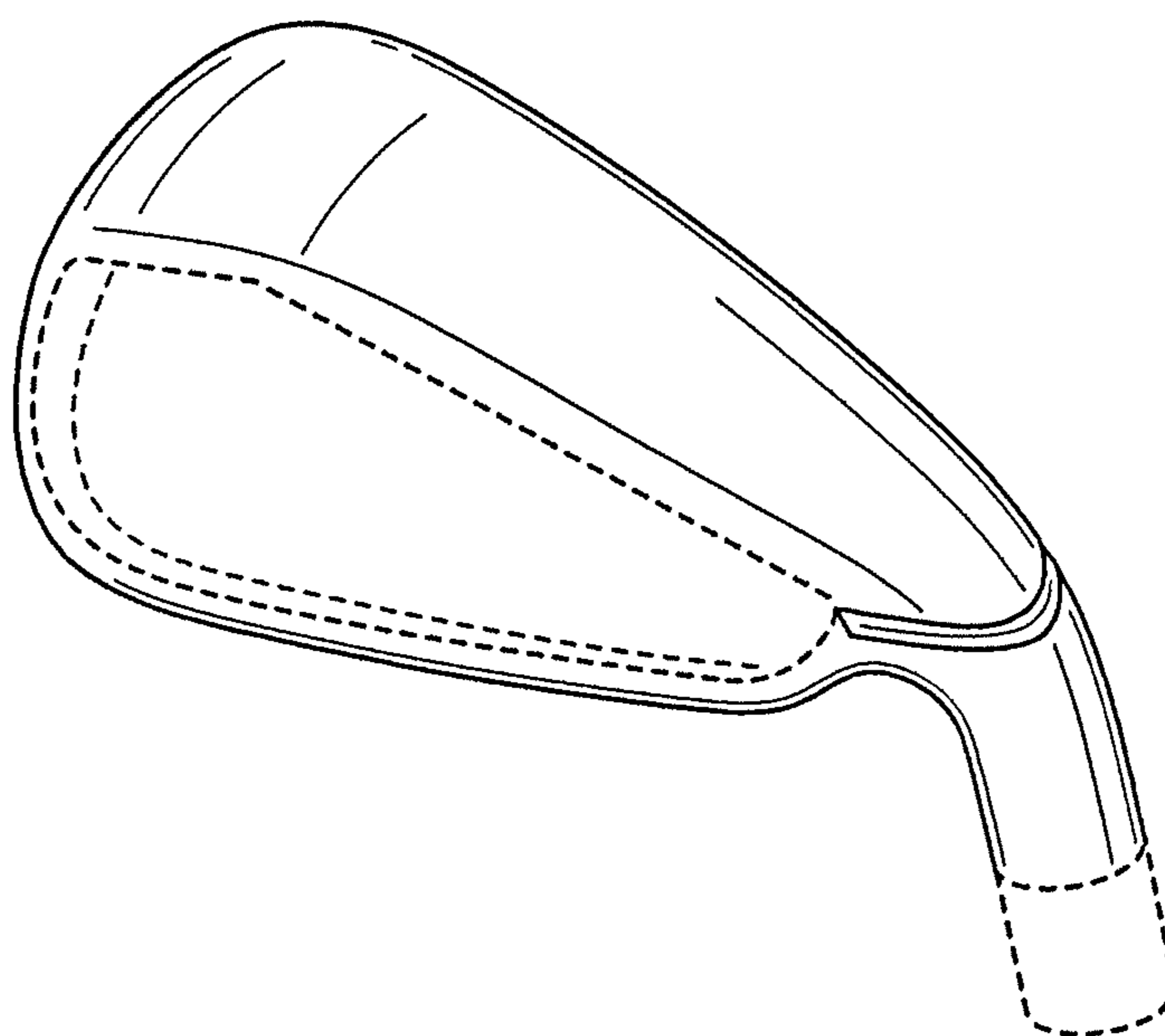

FIG. 8

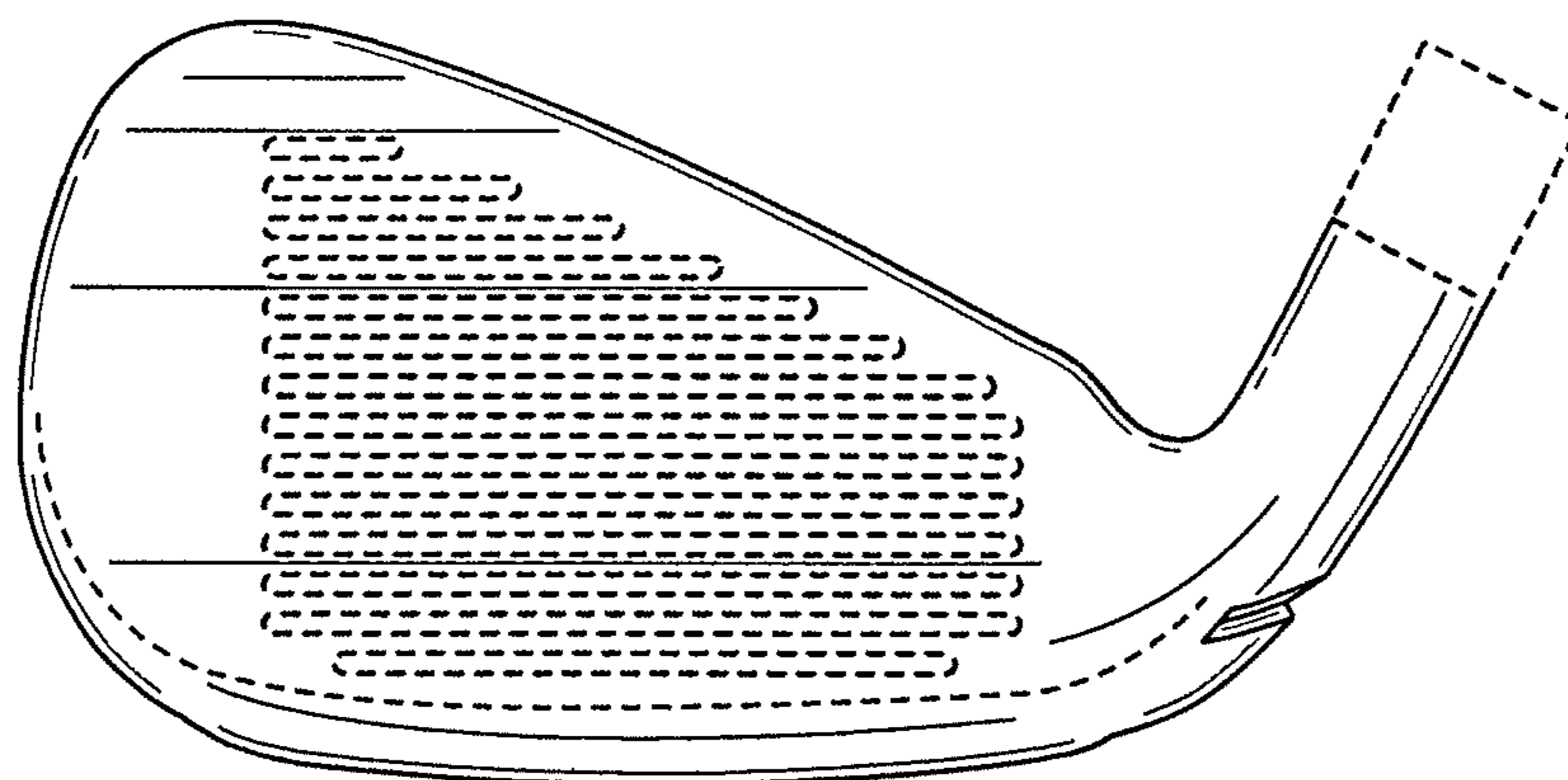

FIG. 9

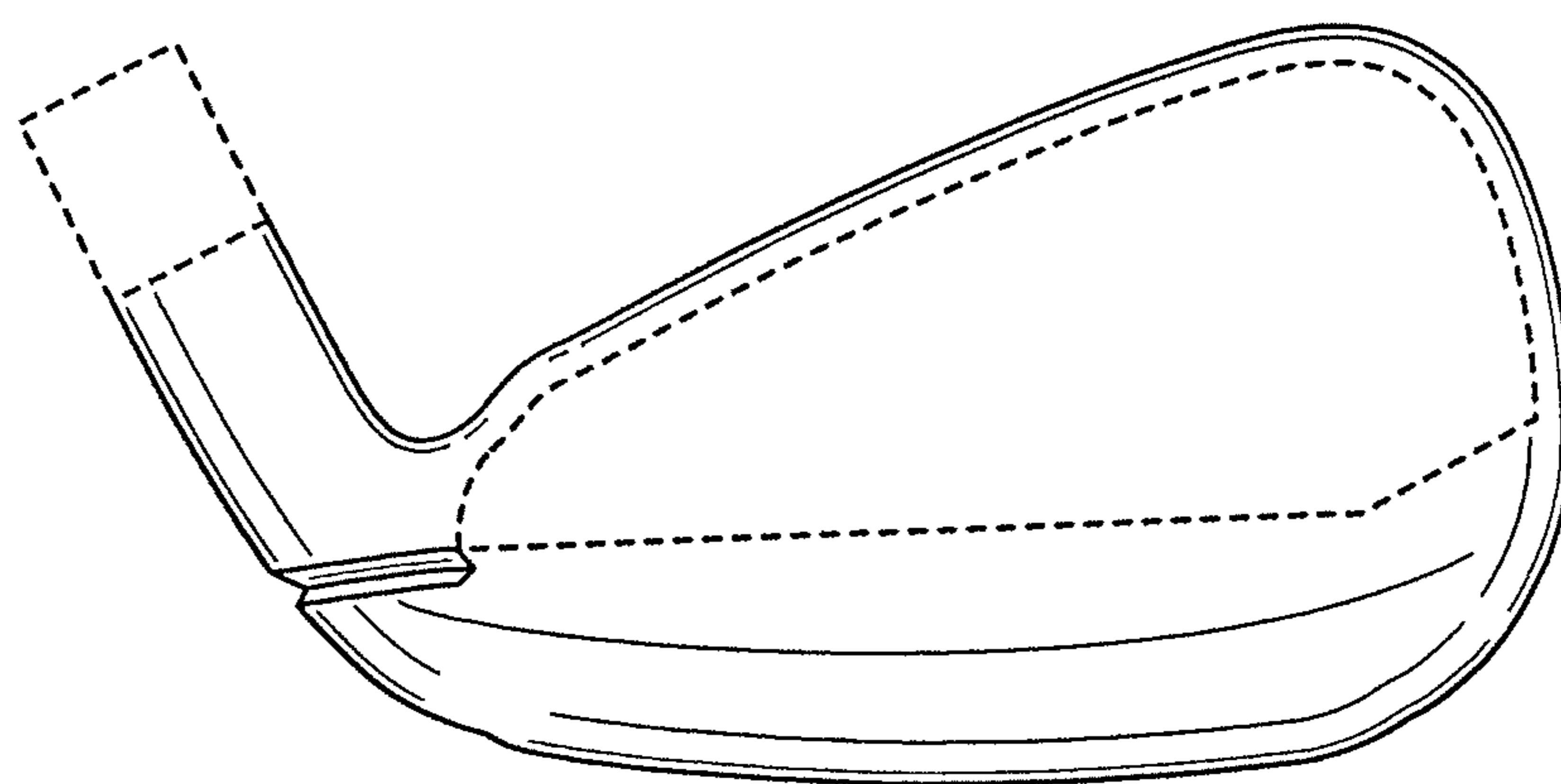

FIG. 10

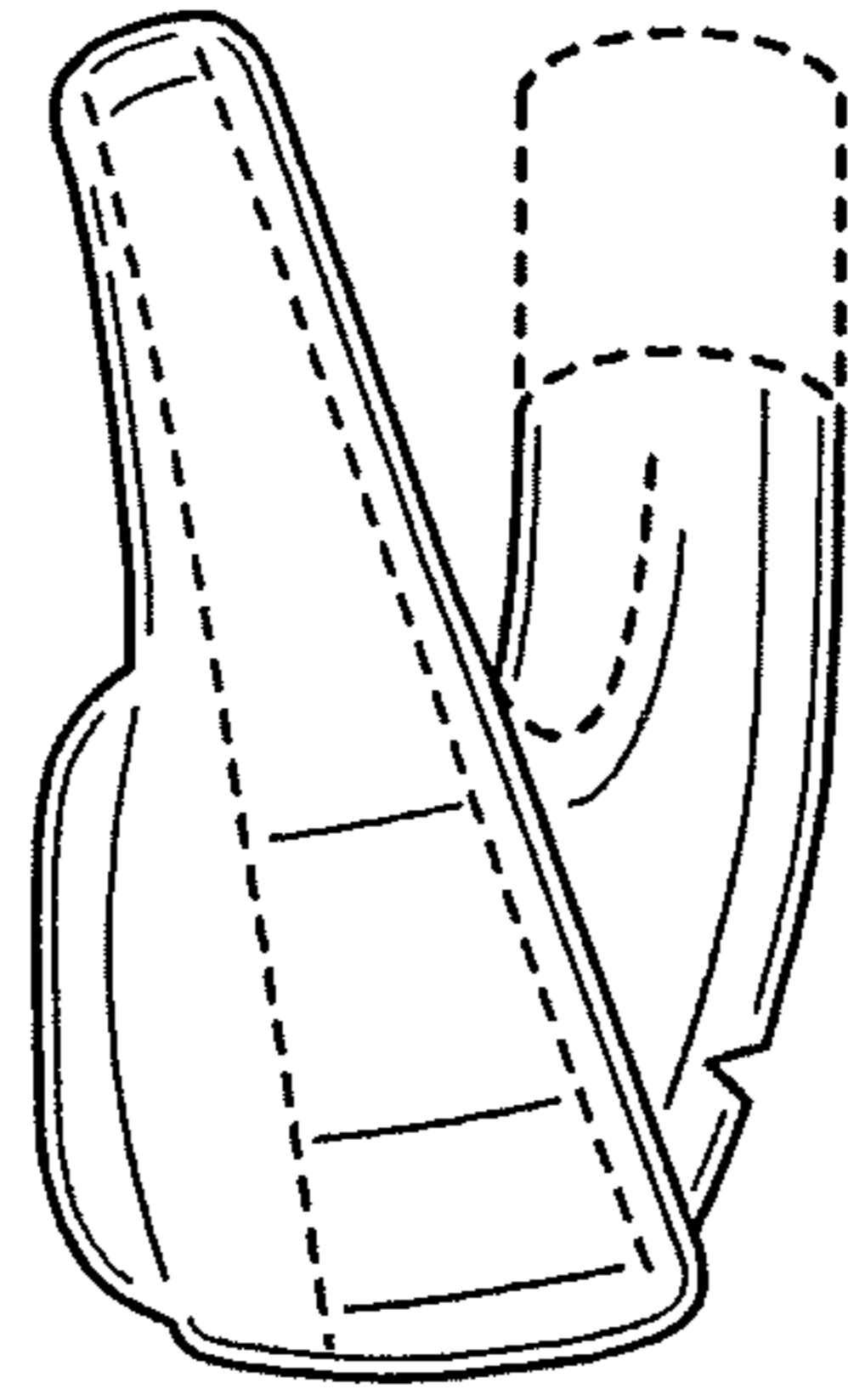

FIG. 11

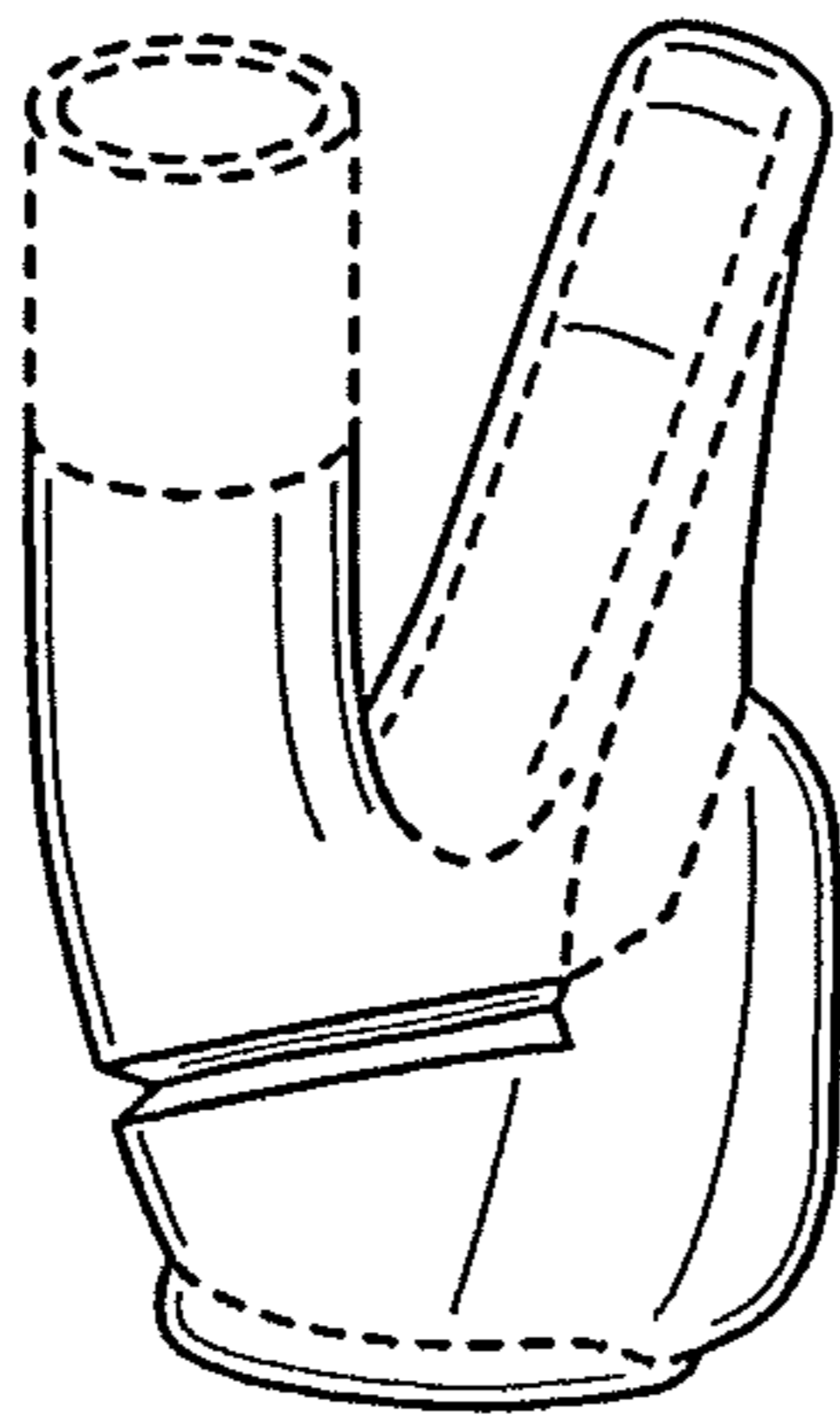

FIG. 12

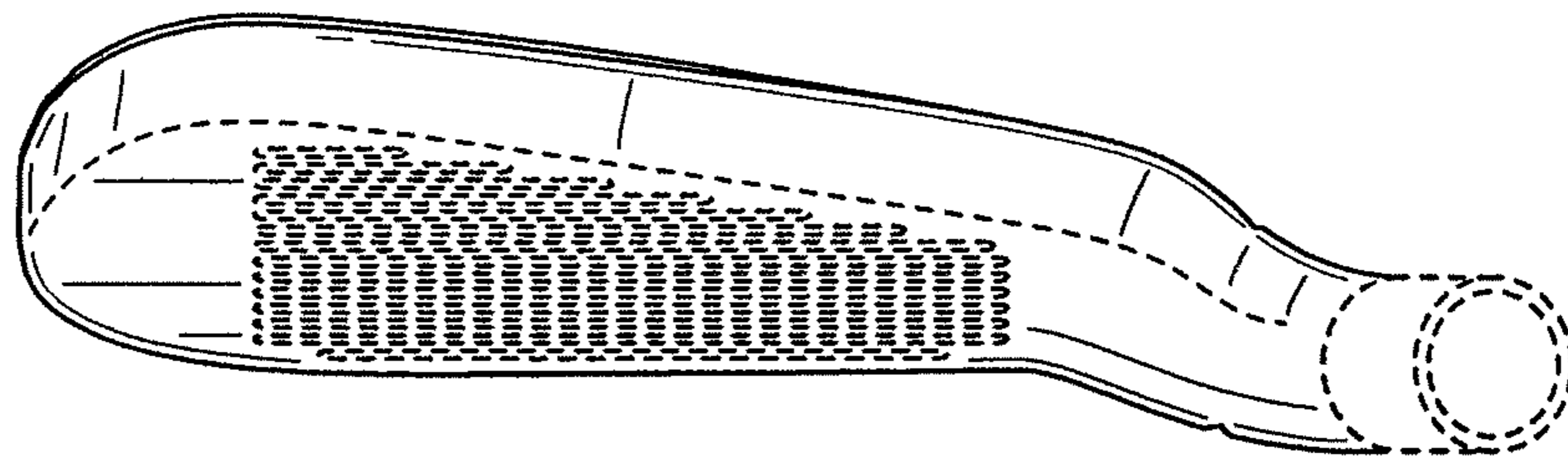

FIG. 13

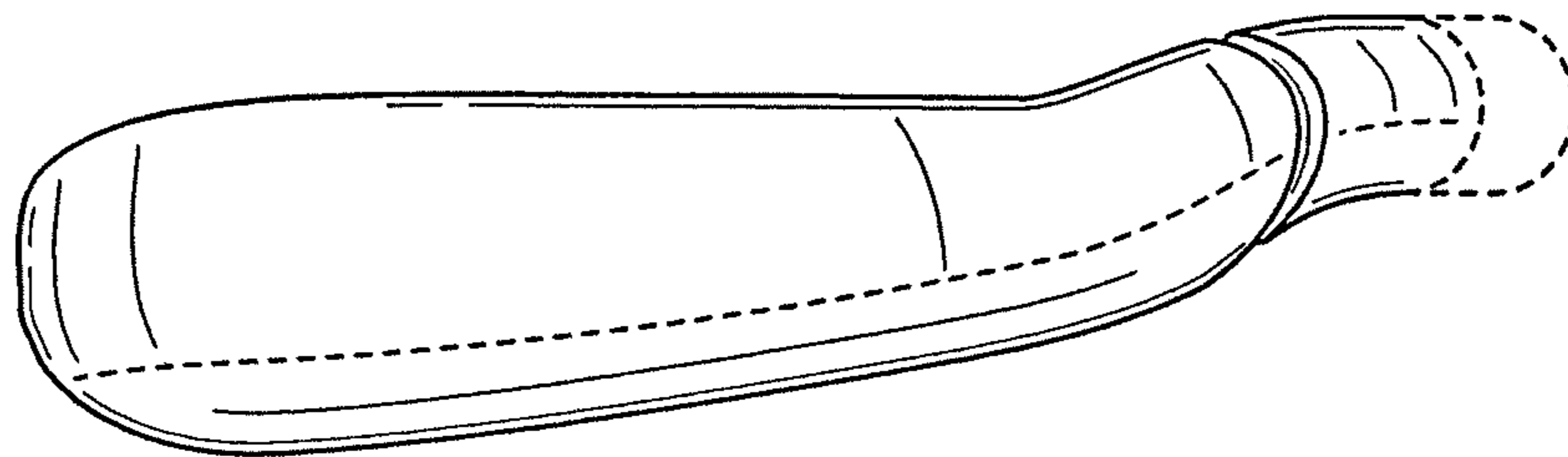

FIG. 14