

US00D696064S

(12) **United States Design Patent**
Hwang

(10) **Patent No.:** **US D696,064 S**

(45) **Date of Patent:** **** Dec. 24, 2013**

(54) **TRIVET**

(76) Inventor: **Suhyun Hwang**, Fort Lee, NJ (US)

(**) Term: **14 Years**

(21) Appl. No.: **29/427,745**

(22) Filed: **Jul. 22, 2012**

(51) **LOC (9) Cl.** **07-99**

(52) **U.S. Cl.**
USPC **D7/388; D7/408; D7/409**

(58) **Field of Classification Search**
USPC D7/300, 388, 387, 408, 213, 407, 409;
D6/536; 211/85.4, 71.01
See application file for complete search history.

(56) **References Cited**

U.S. PATENT DOCUMENTS

| | | | | |
|---------------|---------|-------------|-------|-----------|
| D121,706 S * | 7/1940 | Stanchfield | | D7/408 |
| 2,285,278 A * | 6/1942 | Hennessy | | 126/214 C |
| D142,617 S * | 10/1945 | Coleman | | D7/408 |
| D340,480 S * | 10/1993 | Cummings | | D21/437 |

| | | | | |
|--------------|---------|------------------|-------|--------|
| D538,100 S * | 3/2007 | Dodge | | D7/388 |
| D544,748 S * | 6/2007 | Johansson | | D7/388 |
| D546,119 S * | 7/2007 | Dodge | | D7/388 |
| D604,559 S * | 11/2009 | Woodruff | | D7/408 |
| D660,644 S * | 5/2012 | Beijl et al. | | D7/388 |
| D677,977 S * | 3/2013 | O'Connell et al. | | D7/388 |

* cited by examiner

Primary Examiner — Marianne Pandozzi

(57) **CLAIM**

The ornamental design for a trivet, as shown and described.

DESCRIPTION

FIG. 1 is a top plan view of a trivet showing my new design; FIG. 2 is a front elevational view thereof; the opposite side being a mirror image thereof; FIG. 3 is a bottom elevational view thereof; FIG. 4 is a side elevational view, the opposite side being a mirror image thereof; FIG. 5 is a top isometric view thereof; and, FIG. 6 is a bottom isometric view thereof.

1 Claim, 3 Drawing Sheets

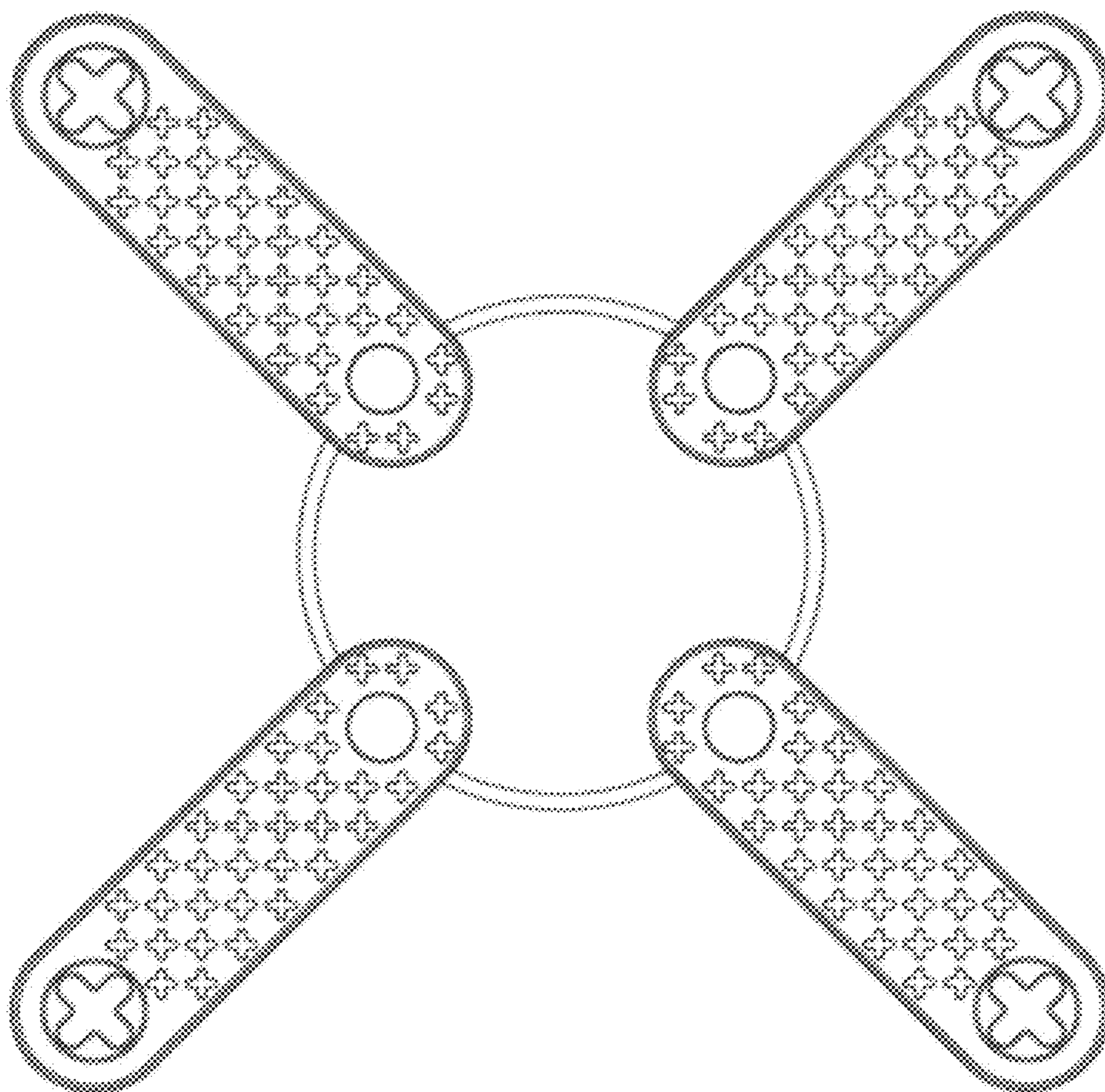

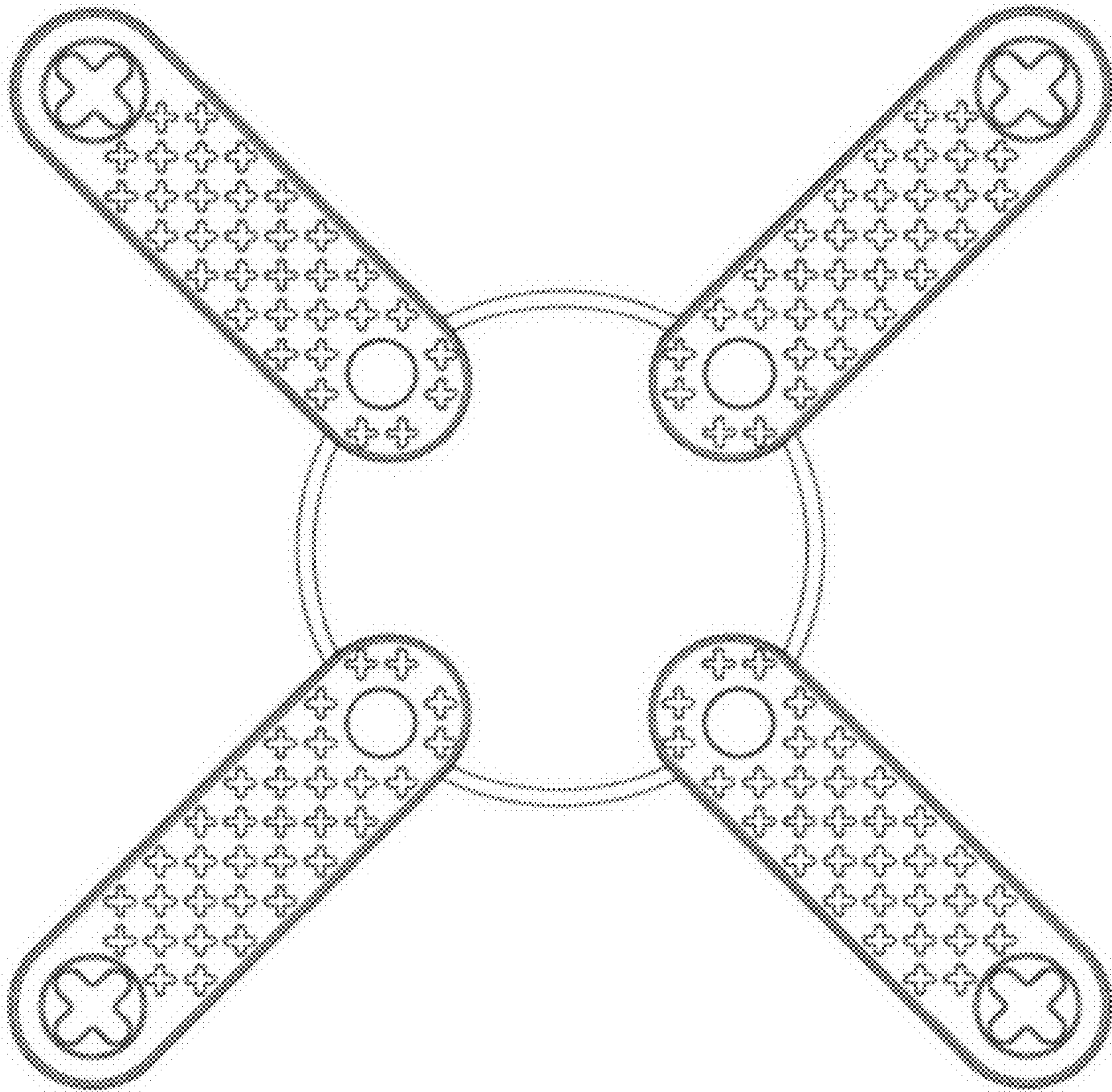

FIG. 1

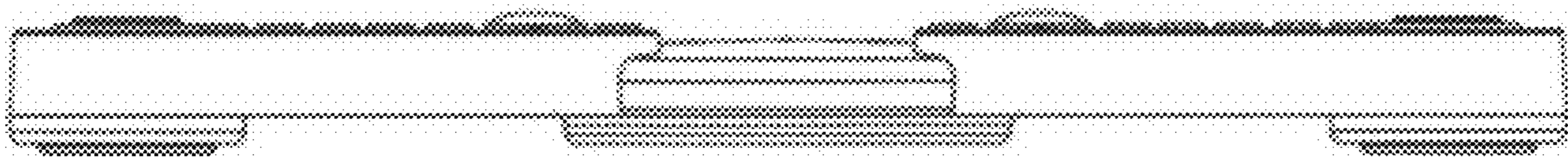

FIG. 2

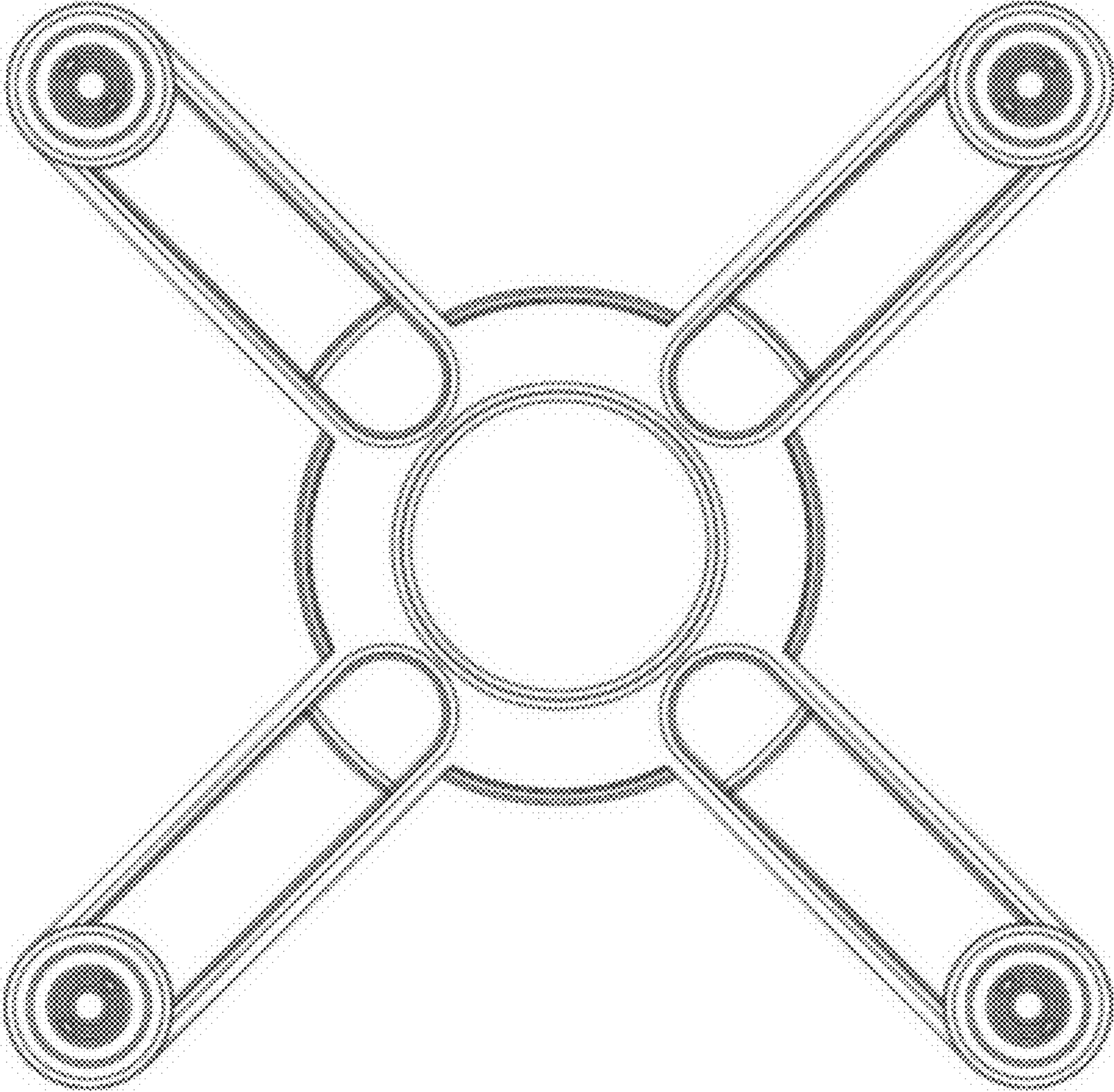

FIG. 3

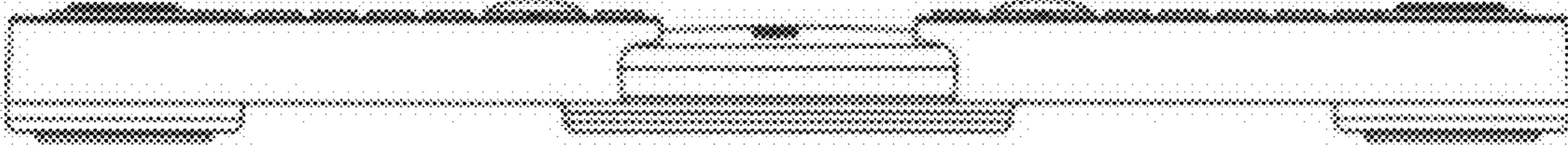

FIG. 4

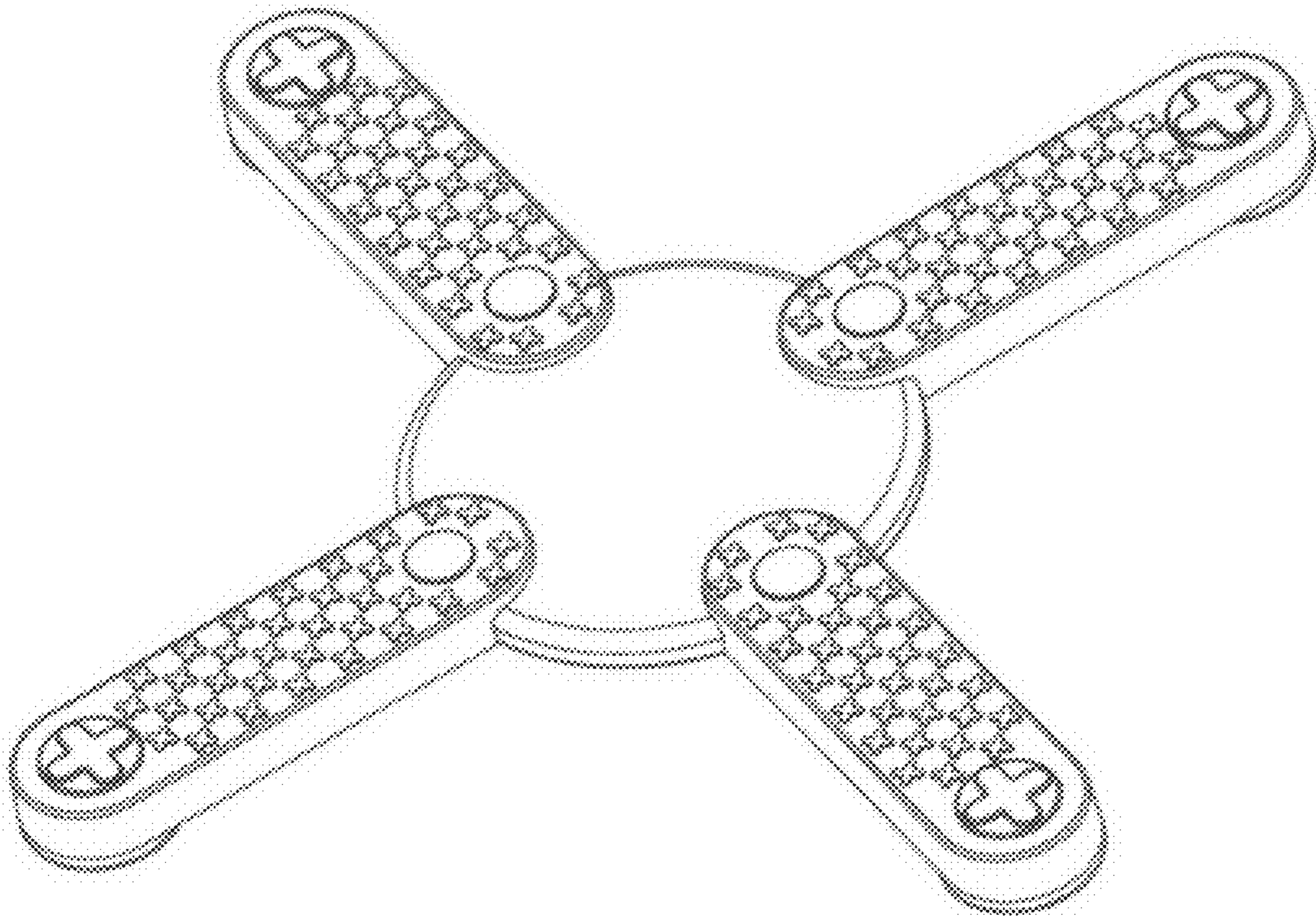

FIG. 5

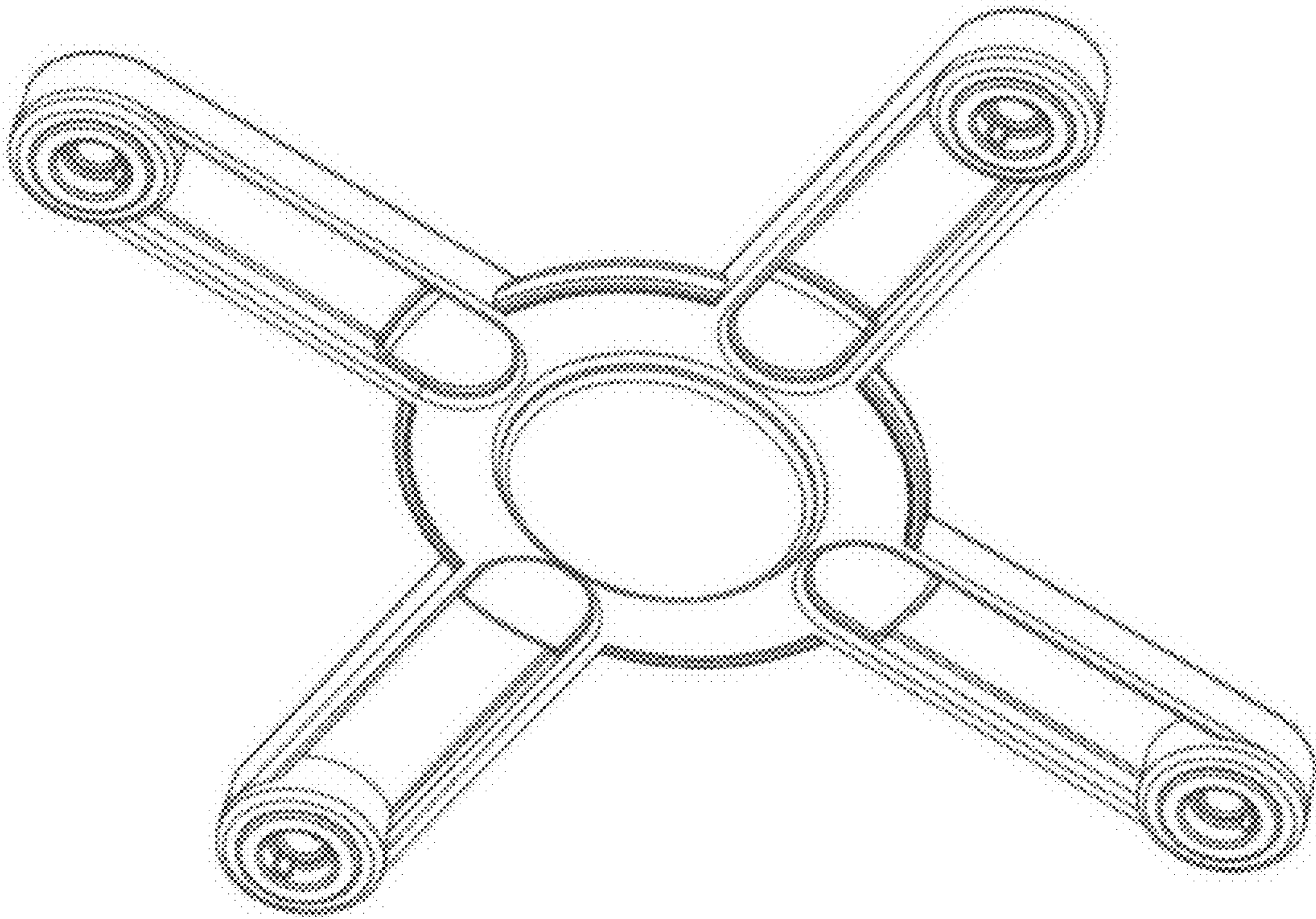

FIG. 6