



US00D696040S

(12) **United States Design Patent**
Tsai

(10) **Patent No.:** **US D696,040 S**

(45) **Date of Patent:** **** Dec. 24, 2013**

(54) **HOLDER FOR BEVERAGE CUP**

(56) **References Cited**

(71) Applicant: **Dongguan Master United Plastic & Hardware Products Co., Ltd.,**
Dongguan (CN)

(72) Inventor: **Tsung-Yu Tsai,** Changhua (TW)

(73) Assignee: **Dongguan Master United Plastic & Hardware Products Co., Ltd.,**
Dongguan, Guandong Province (CN)

(**) Term: **14 Years**

(21) Appl. No.: **29/447,266**

(22) Filed: **Mar. 1, 2013**

(51) **LOC (9) Cl.** **20-02**

(52) **U.S. Cl.**
USPC **D6/515; D7/600.1**

(58) **Field of Classification Search**
USPC D7/619.1-625, 600.1-600.4, 590, 704;
D6/408, 463, 515, 462, 417, 535, 552,
D6/556, 566, 567, 517, 553; 211/59.2,
211/181.1, 74, 71.01, 14, 13.1, 49.1, 59.1,
211/85.11, 106; 206/499; 47/39, 47, 41.14

See application file for complete search history.

U.S. PATENT DOCUMENTS

D636,639 S * 4/2011 Chen D7/600.1
D646,526 S * 10/2011 Chen D7/600.1
D651,435 S * 1/2012 Dieudonne et al. D6/515
D653,503 S * 2/2012 Chen D7/600.1

* cited by examiner

Primary Examiner — Brian N Vinson

(74) *Attorney, Agent, or Firm* — Muncy, Geissler, Olds & Lowe, PLLC

(57) **CLAIM**

The ornamental design for a holder for beverage cup, as shown and described.

DESCRIPTION

FIG. 1 shows a perspective view of the present design.
FIG. 2 shows a front view of the present design,
FIG. 3 shows a rear view of the present design.
FIG. 4 shows a left side view of the present design
FIG. 5 shows a right side view of the present design.
FIG. 6 shows a top view of the present design; and,
FIG. 7 shows a bottom view of the present design.

1 Claim, 4 Drawing Sheets

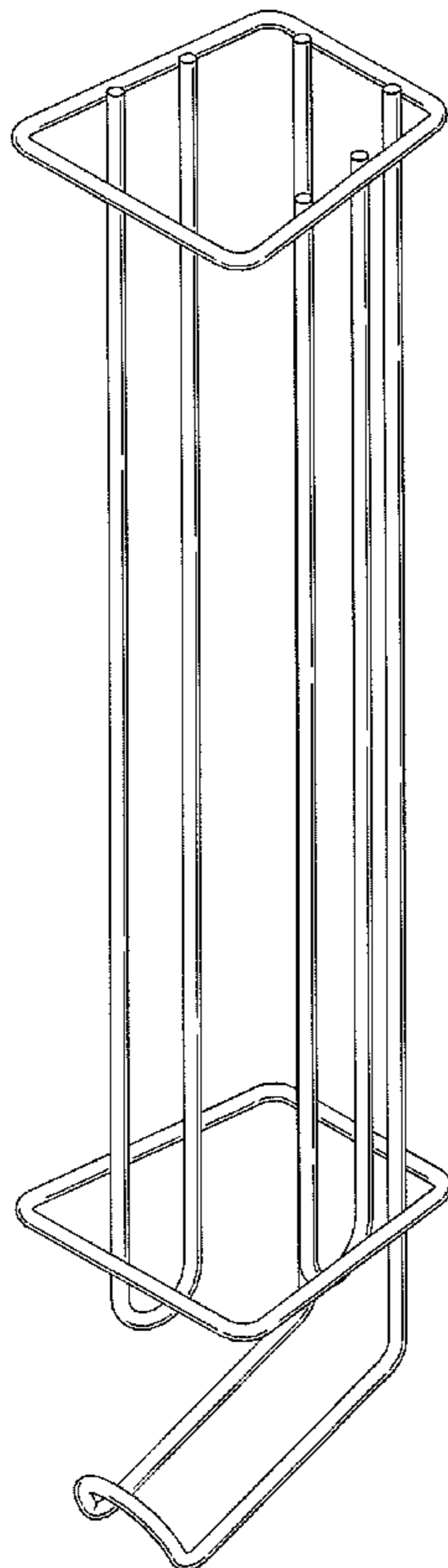

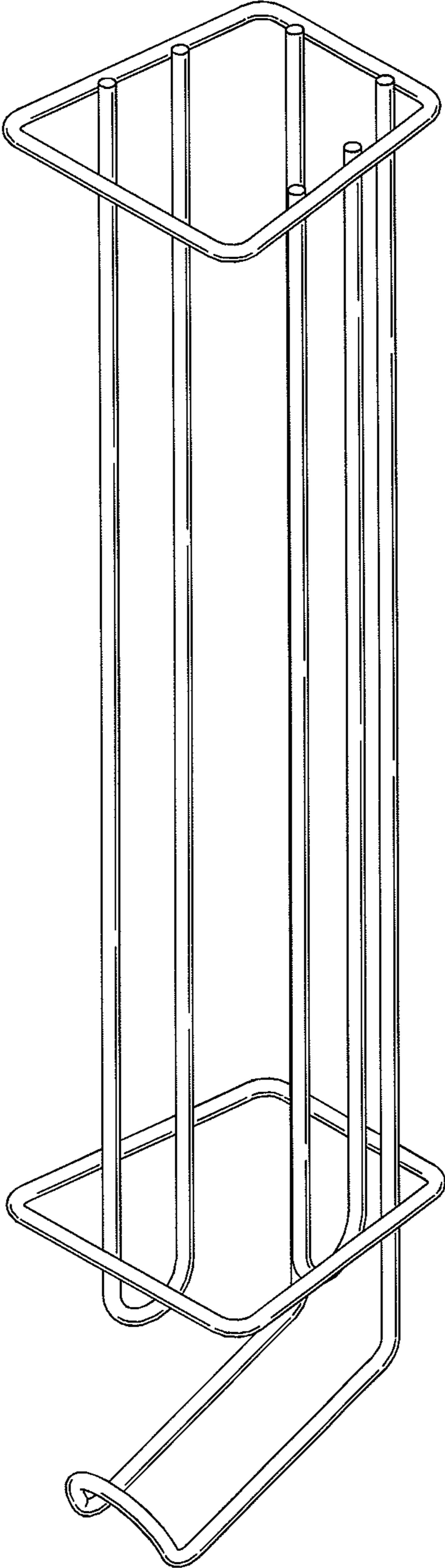

FIG. 1

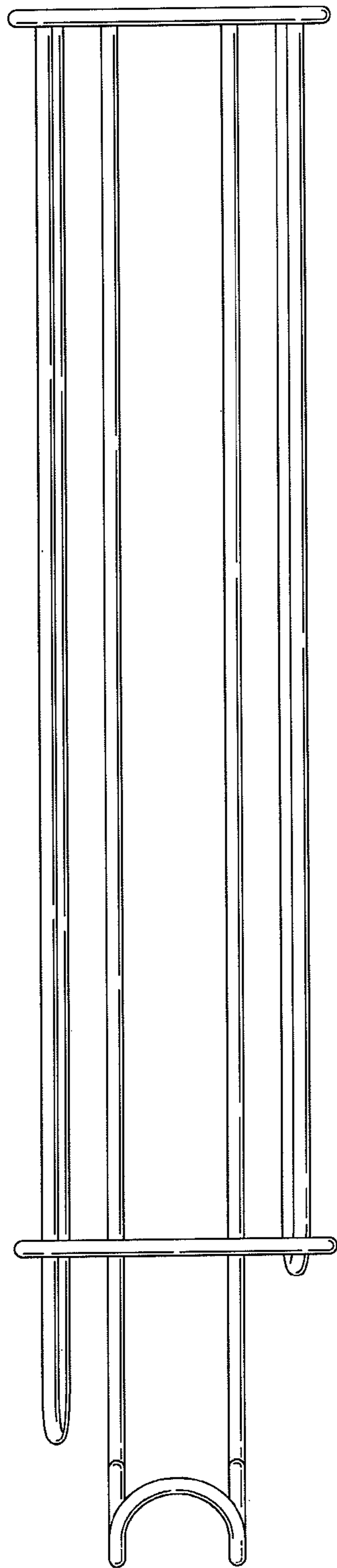

FIG. 2

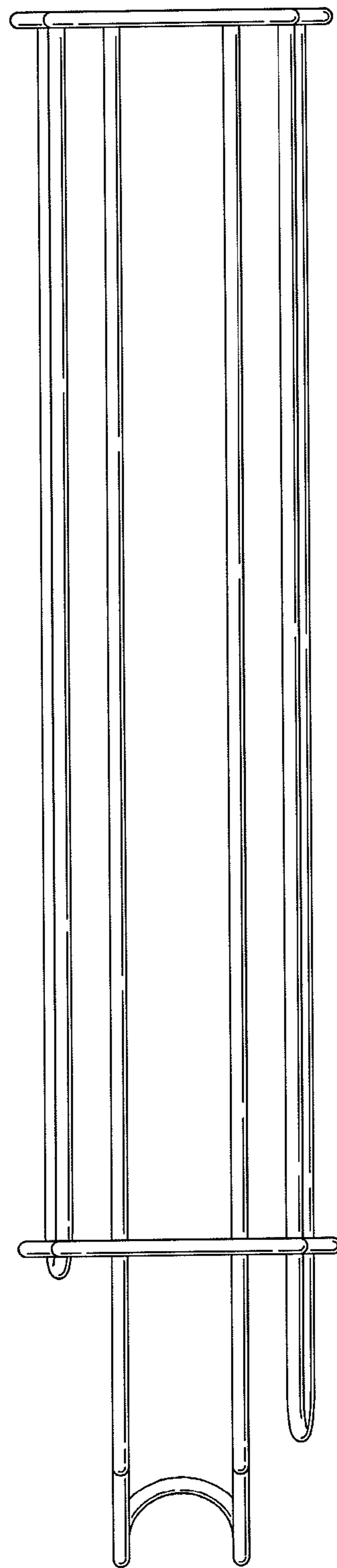

FIG. 3



FIG. 4

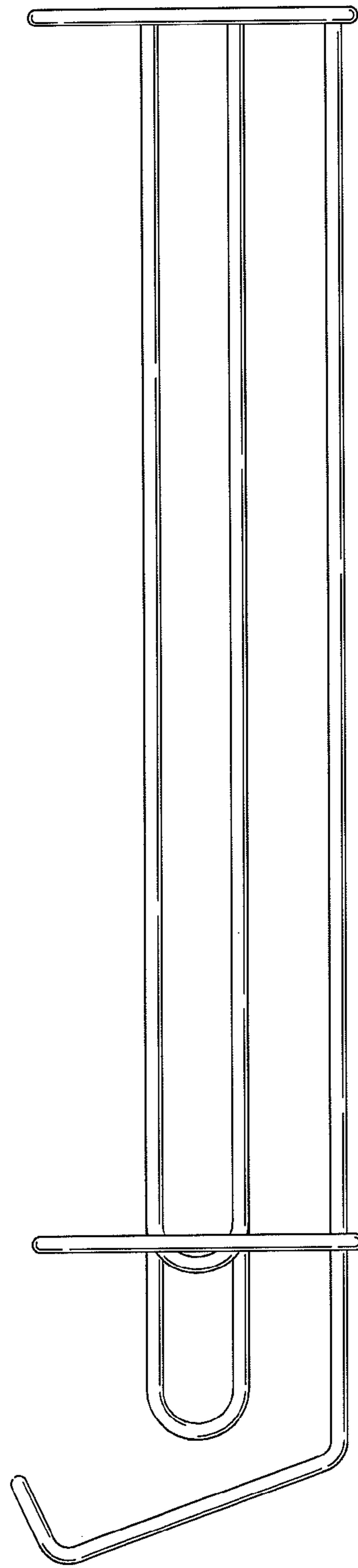

FIG. 5

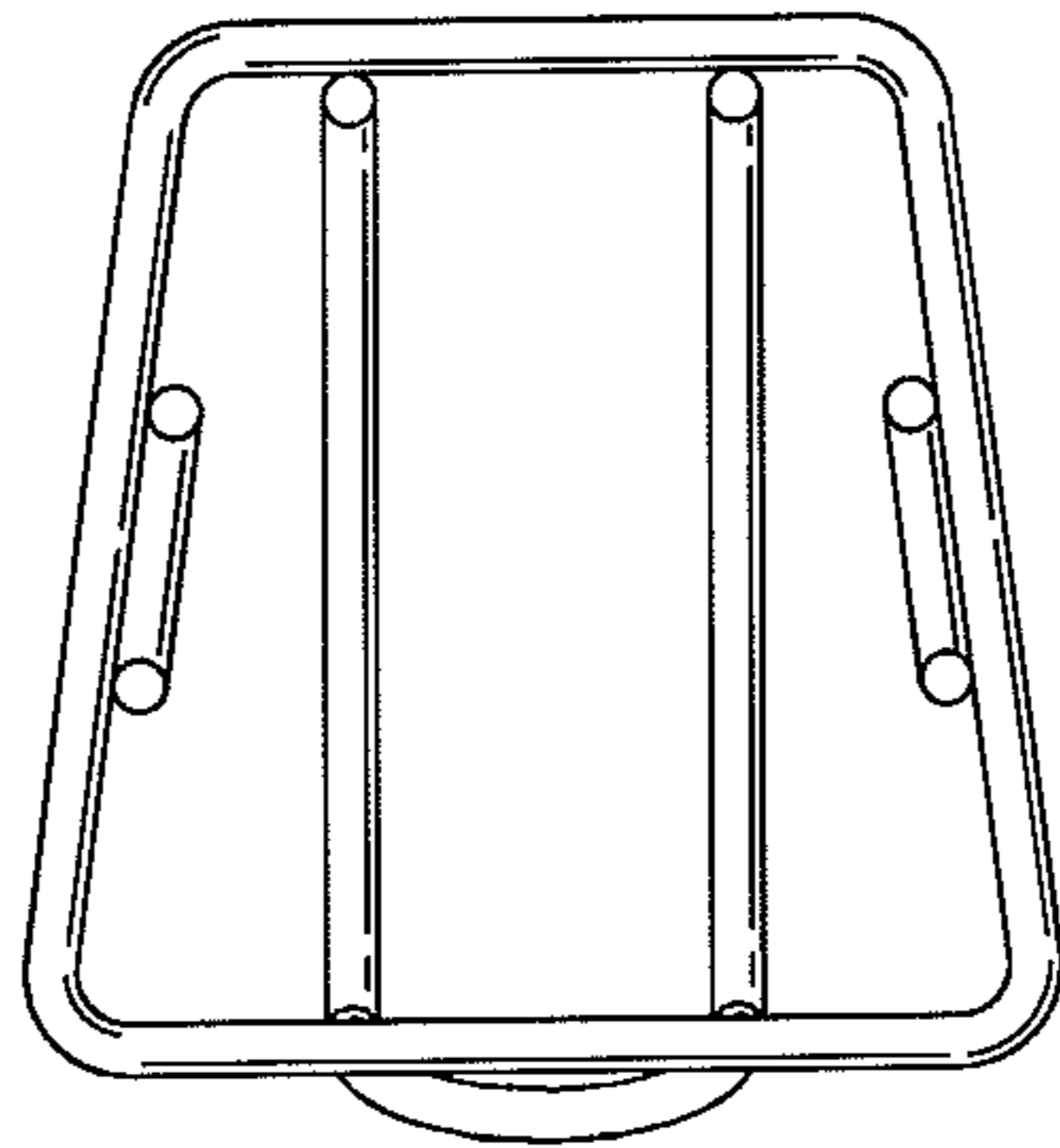

FIG. 6

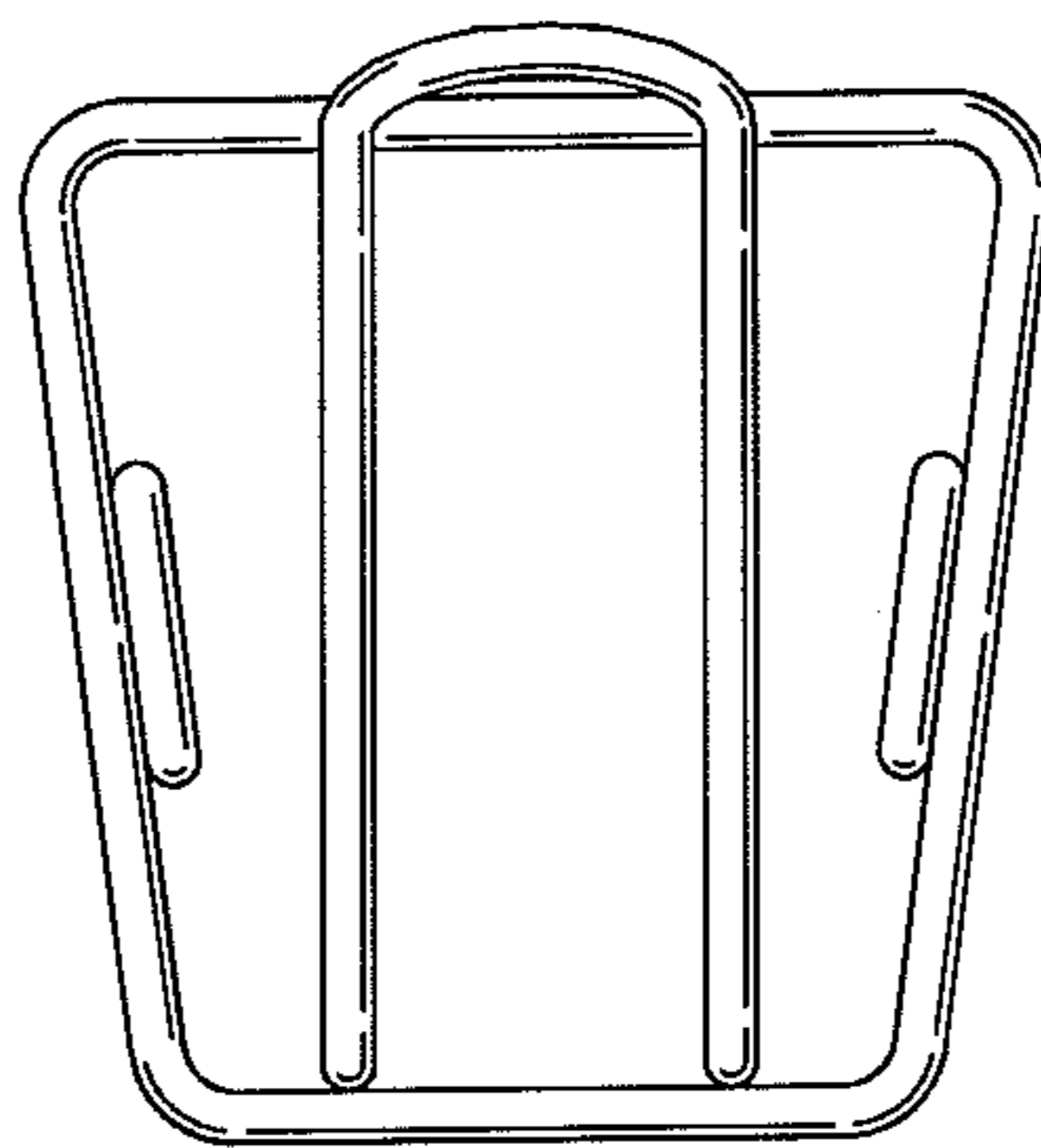

FIG. 7