



US00D695939S

(12) **United States Design Patent**
Fang

(10) **Patent No.:** **US D695,939 S**

(45) **Date of Patent:** **** Dec. 17, 2013**

(54) **LIGHTING APPARATUS**

(75) Inventor: **Yi Fang, Yuyao (CN)**

(73) Assignee: **Ningbo UTEC Electric Co. Ltd (CN)**

(**) Term: **14 Years**

(21) Appl. No.: **29/418,513**

(22) Filed: **Apr. 17, 2012**

(51) **LOC (9) Cl.** **26-03**

(52) **U.S. Cl.**
USPC **D26/72**

(58) **Field of Classification Search**
USPC D26/71, 72, 76, 67, 24, 26; 362/147,
362/432, 431, 294, 317, 362
See application file for complete search history.

(56) **References Cited**

U.S. PATENT DOCUMENTS

D228,667 S * 10/1973 Anderson, Jr. D26/71
D422,107 S * 3/2000 Meier D26/72
D491,306 S * 6/2004 Zucker D26/72

D591,445 S * 4/2009 Guercio D26/71
D604,004 S * 11/2009 Guercio D26/85
D606,227 S * 12/2009 Erickson et al. D26/72

* cited by examiner

Primary Examiner — Brian N Vinson

(74) *Attorney, Agent, or Firm* — Raymond Sun

(57) **CLAIM**

The ornamental design for a lighting apparatus, as shown and described.

DESCRIPTION

FIG. 1 is a perspective view of a lighting apparatus showing my new design.

FIG. 2 is a top plan view thereof;

FIG. 3 is a bottom plan view thereof;

FIG. 4 is a front elevational view thereof;

FIG. 5 is a rear elevational view thereof;

FIG. 6 is a left side elevational view thereof; and,

FIG. 7 is a right side elevational view of the lighting apparatus.

The features shown in the broken lines in FIG. 5 do not represent claimed subject matter.

1 Claim, 7 Drawing Sheets

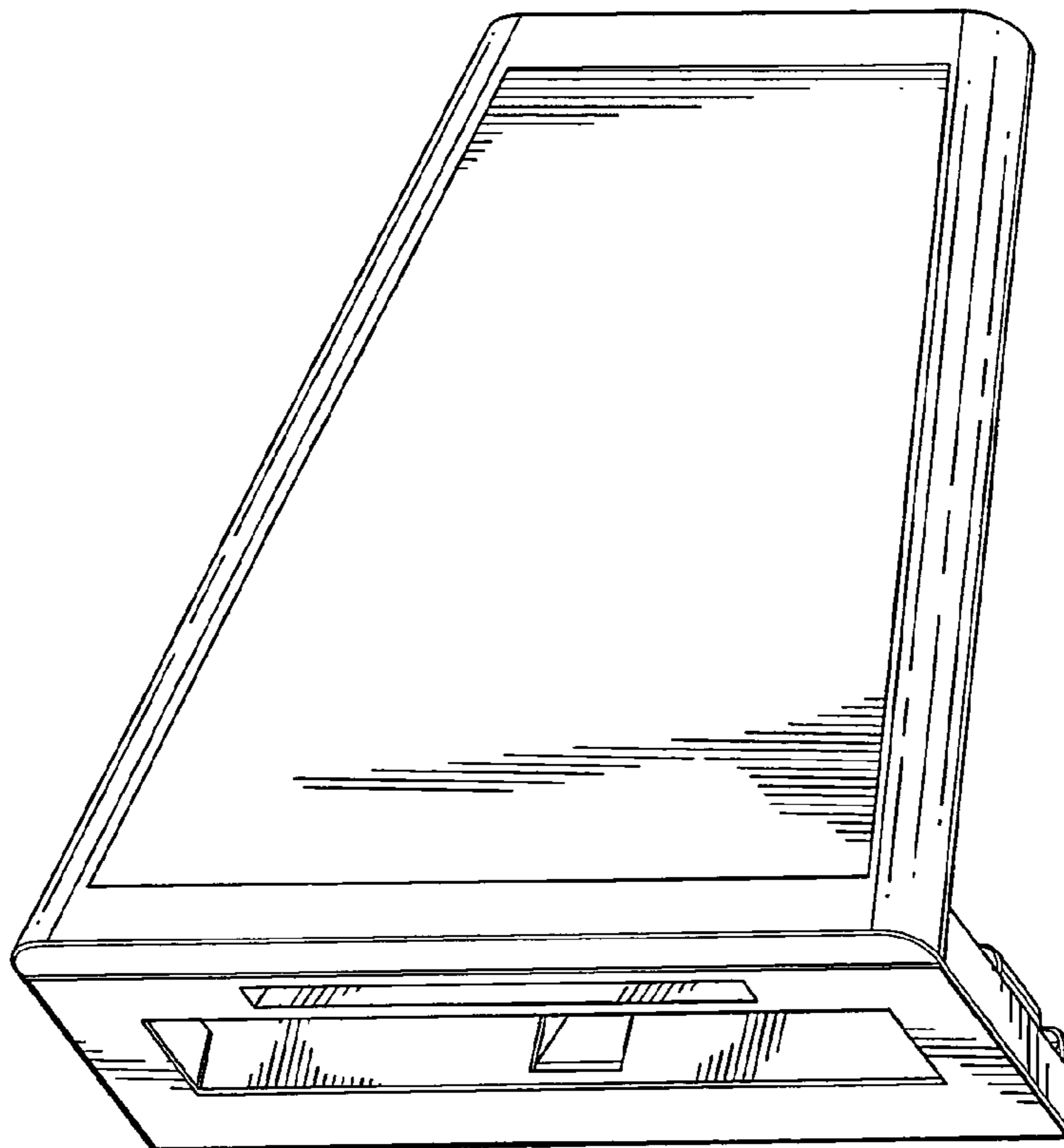

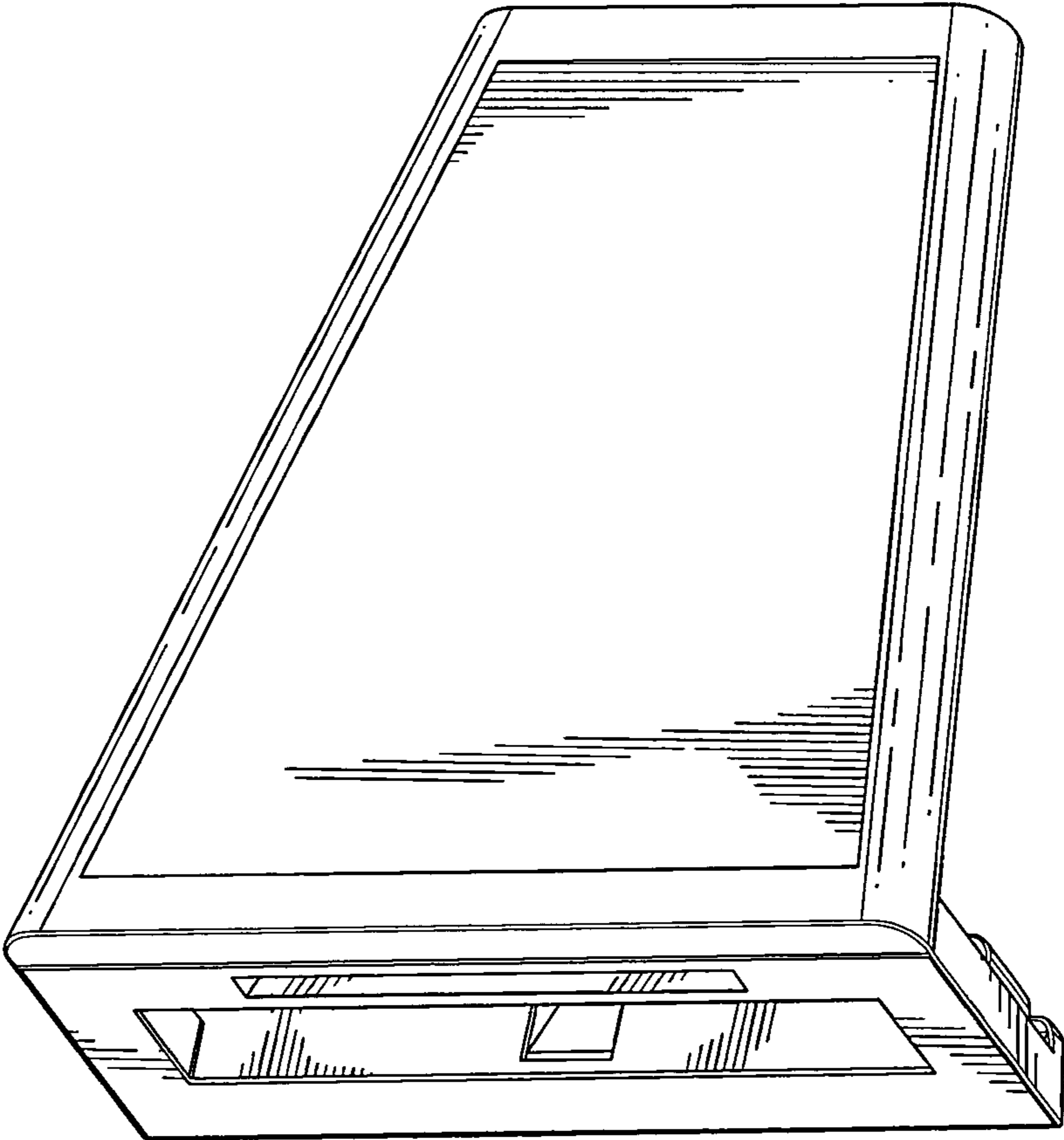

FIG. 1

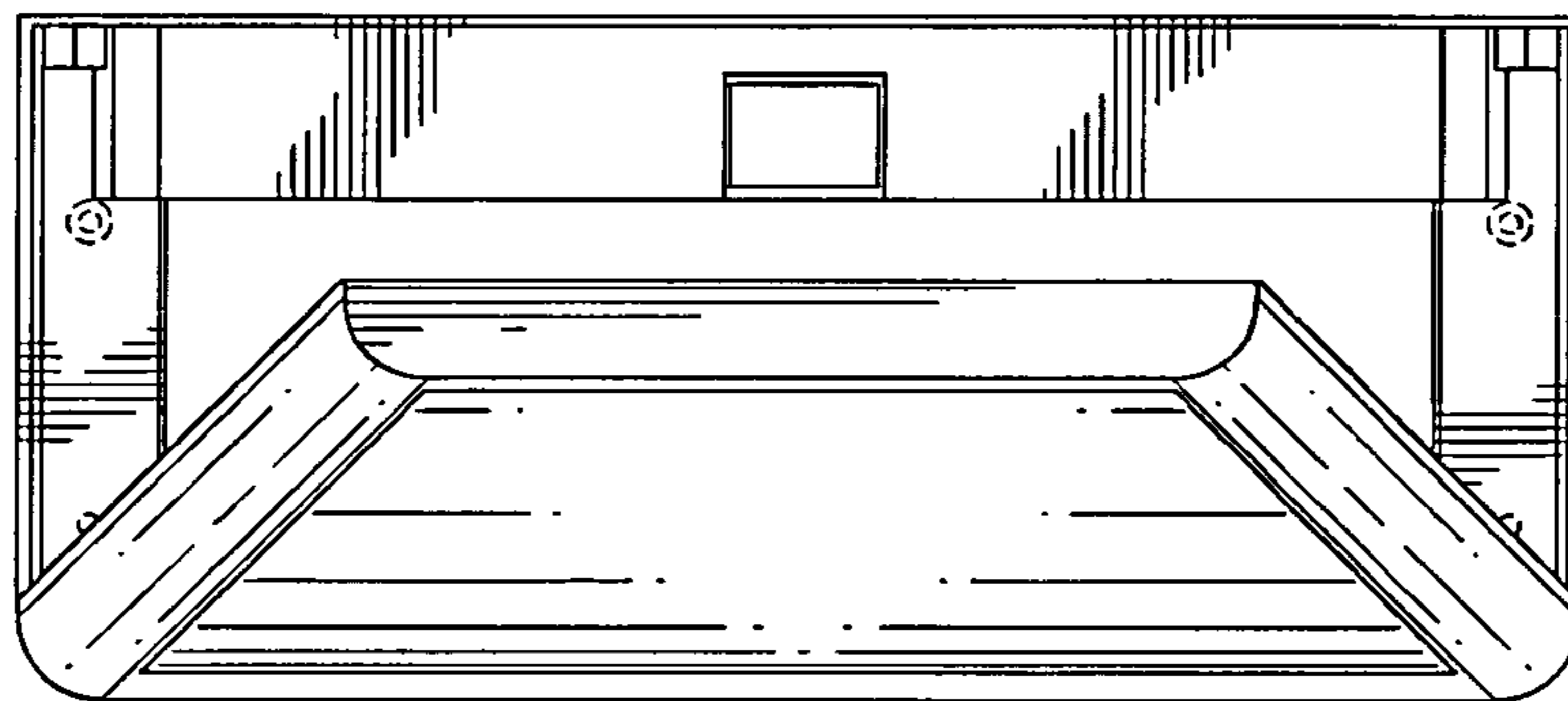

FIG.2

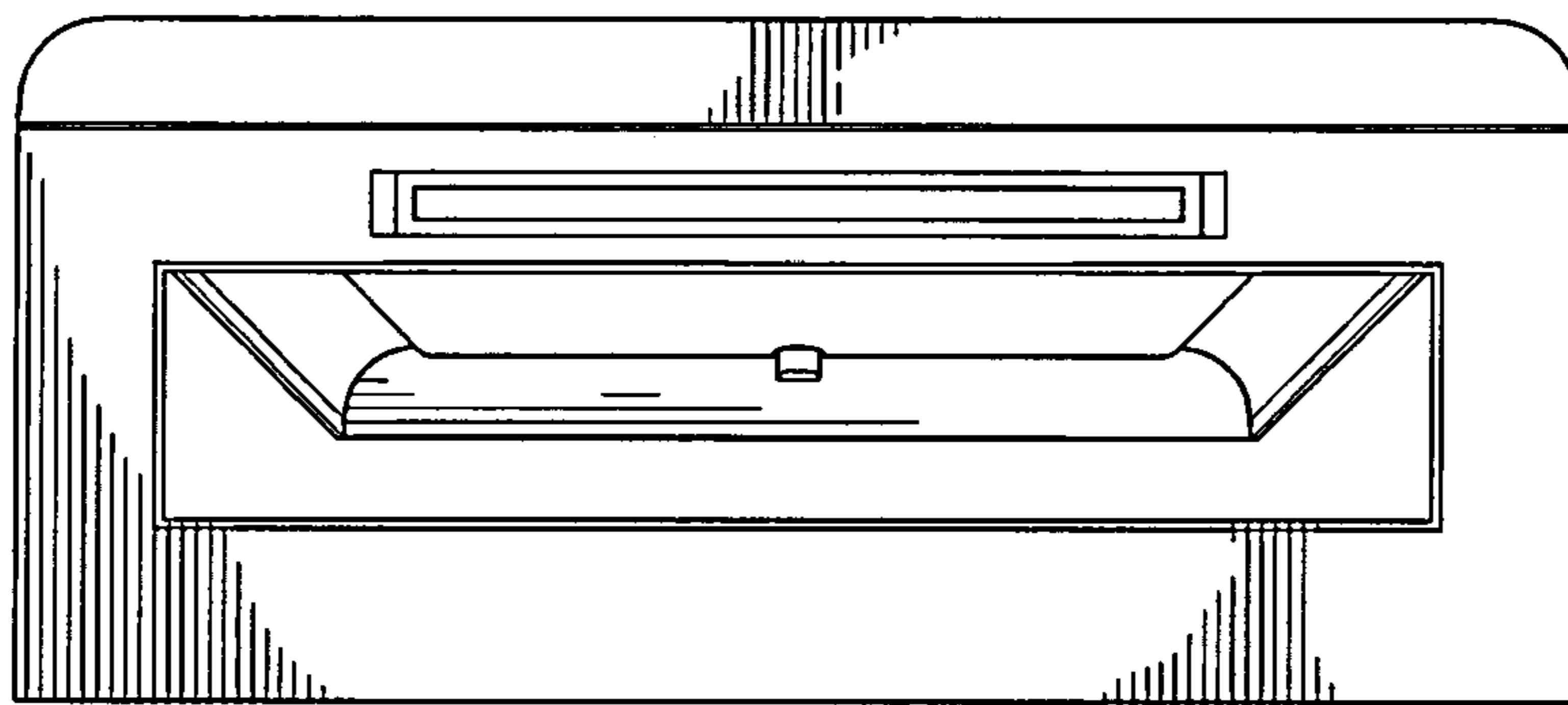

FIG. 3

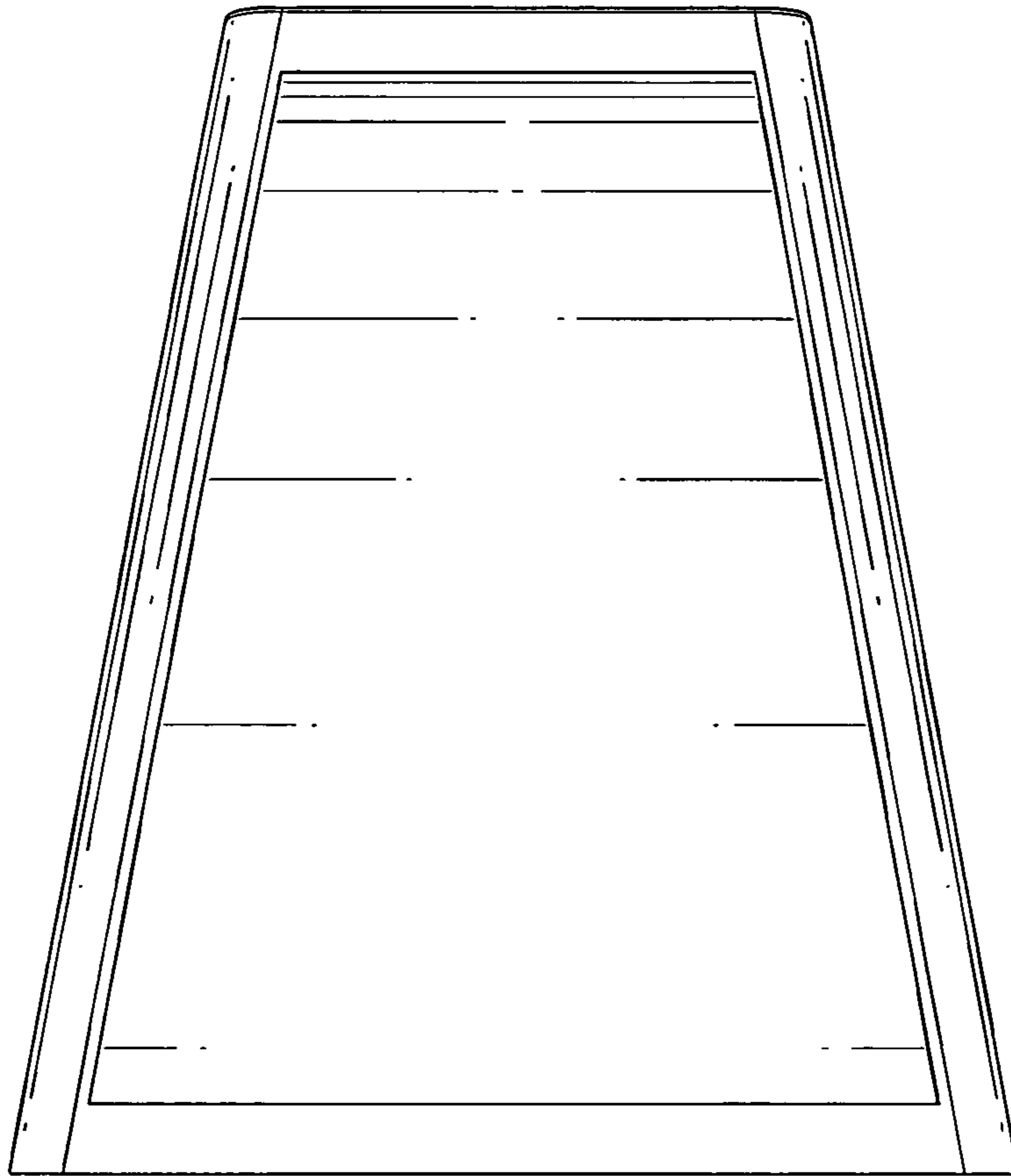

FIG. 4

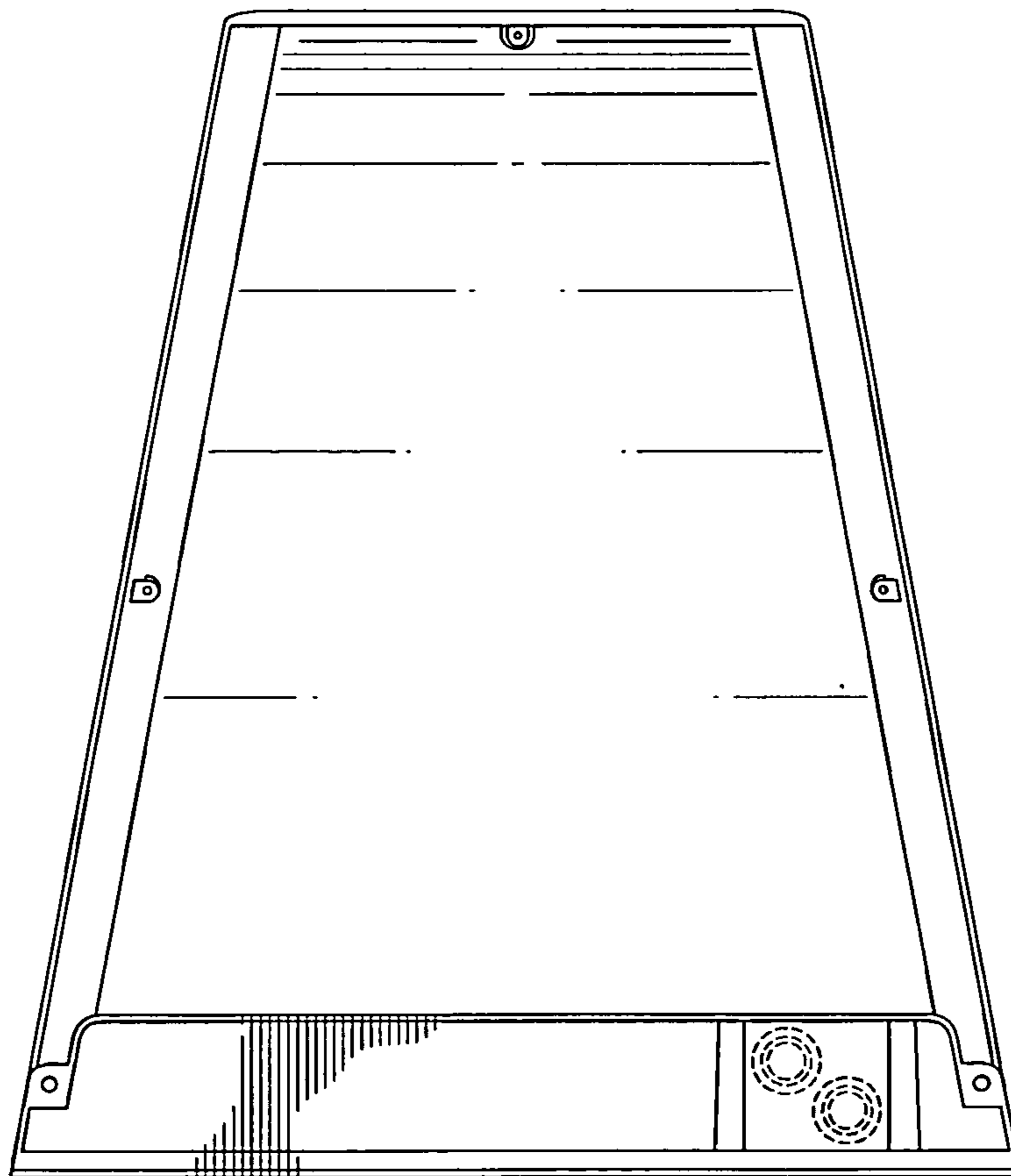

FIG. 5

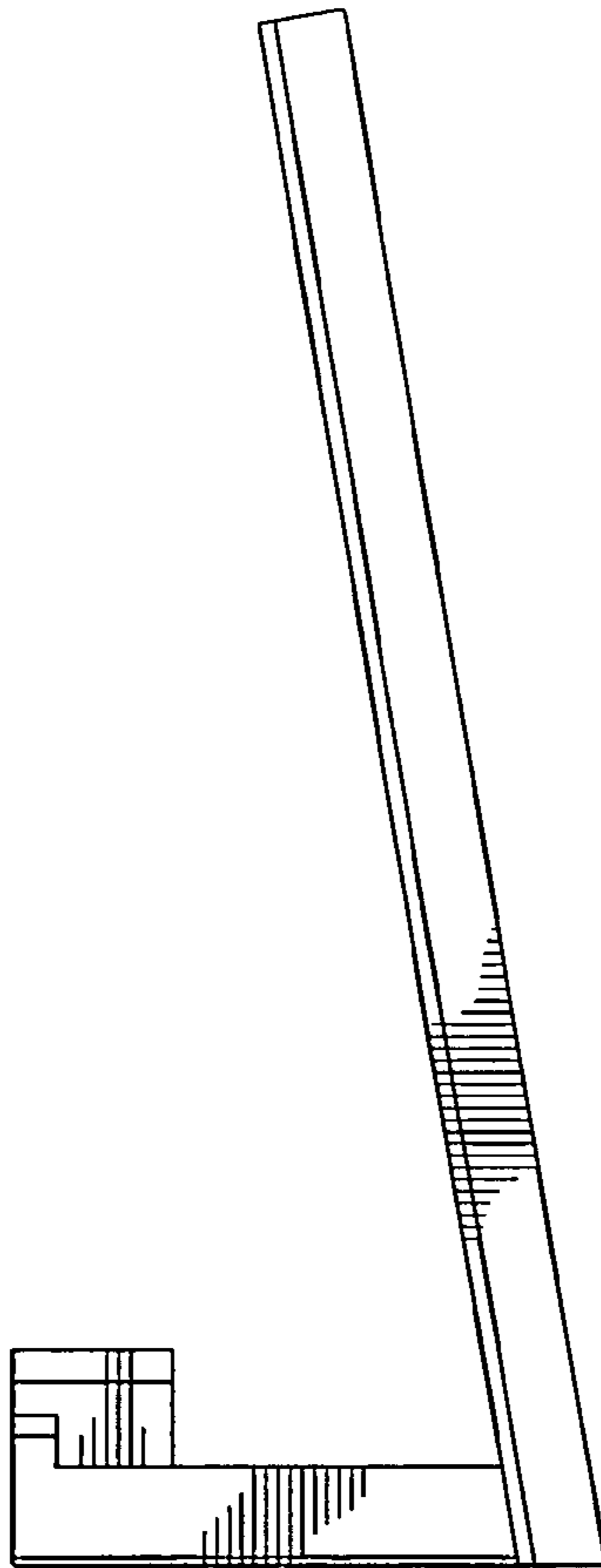

FIG. 6

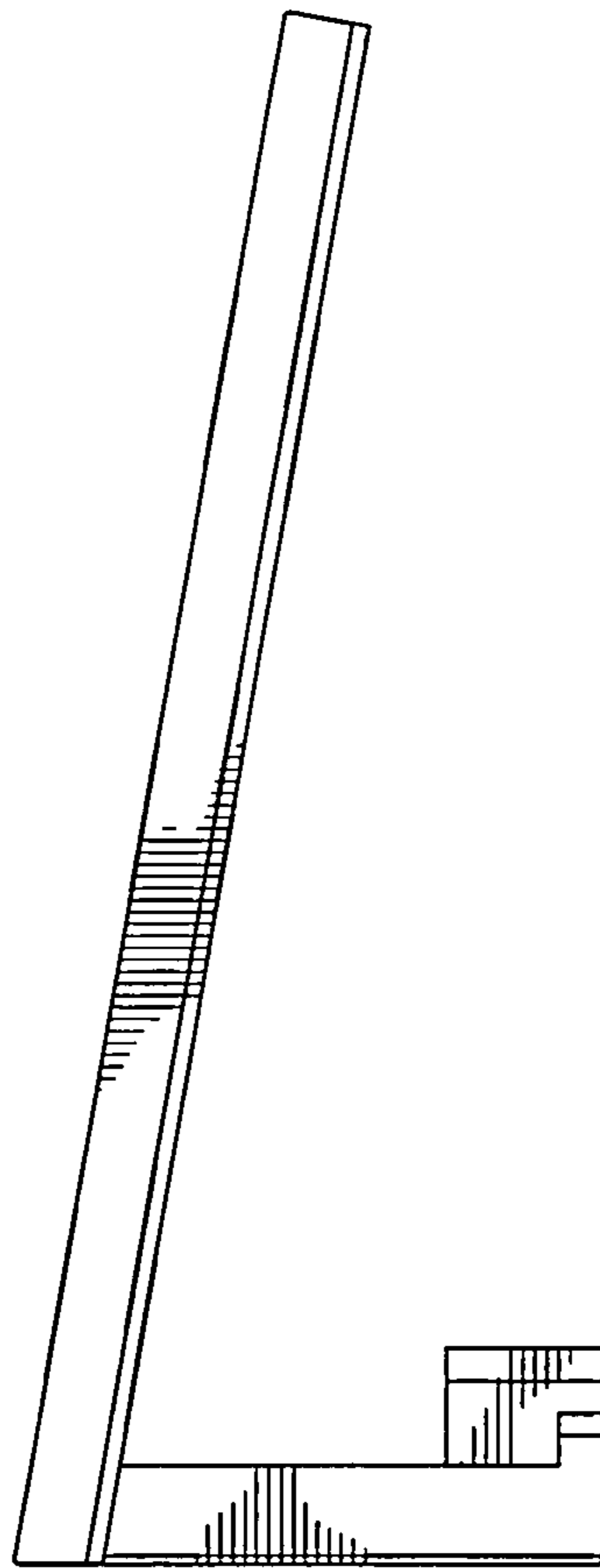

FIG. 7