



US00D695720S

(12) **United States Design Patent**
Chee

(10) **Patent No.:** **US D695,720 S**

(45) **Date of Patent:** **** Dec. 17, 2013**

(54) **HEADPHONES**

(71) Applicant: **Sennheiser electronic GmbH & Co. KG, Wedemark (DE)**

(72) Inventor: **Daniel Eu Leng Chee, Alexandra Technopark (SG)**

(73) Assignee: **Sennheiser electronic GmbH & Co. KG, Wedemark (DE)**

(**) Term: **14 Years**

(21) Appl. No.: **29/436,993**

(22) Filed: **Nov. 12, 2012**

(30) **Foreign Application Priority Data**

May 22, 2012 (EM) 0013273160005

(51) **LOC (9) Cl.** **14-01**

(52) **U.S. Cl.**
USPC **D14/223; D14/206**

(58) **Field of Classification Search**
USPC D14/205, 206, 223; D24/174; 181/129, 181/130, 135; 379/430, 431; 381/380, 381, 381/330; 455/90.3, 575.1
See application file for complete search history.

(56) **References Cited**

U.S. PATENT DOCUMENTS

D504,673 S * 5/2005 Dyer et al. D14/205
D506,462 S * 6/2005 Han et al. D14/205
7,089,042 B2 * 8/2006 Bodley 455/569.1
D579,444 S * 10/2008 Ewert et al. D14/223

D604,272 S * 11/2009 Kitayama D14/223
D604,419 S * 11/2009 Mori et al. D24/174
D618,211 S * 6/2010 Oguro et al. D14/205
D625,297 S * 10/2010 Tseng et al. D14/223
D636,763 S * 4/2011 Walter D14/223
D644,213 S * 8/2011 Quek D14/223
D651,196 S * 12/2011 Quek D14/223
D652,024 S * 1/2012 Quek D14/223
D653,244 S * 1/2012 Birger D14/223
D662,915 S * 7/2012 Halkosaari et al. D14/223

* cited by examiner

Primary Examiner — Paula Greene

(74) *Attorney, Agent, or Firm* — Frommer Lawrence & Haug LLP

(57) **CLAIM**

The ornamental design for headphones, as shown and described.

DESCRIPTION

FIG. 1 is a bottom view of the headphones in accordance with the invention.

FIG. 2 is a top view of the headphones in accordance with the invention.

FIG. 3 is a front view of the headphones in accordance with the invention.

FIG. 4 is a rear view of the headphones in accordance with the invention.

FIG. 5 is a left view of the headphones in accordance with the invention.

FIG. 6 is a right view of the headphones in accordance with the invention; and,

FIG. 7 is a perspective view of the headphones in accordance with the invention.

1 Claim, 6 Drawing Sheets

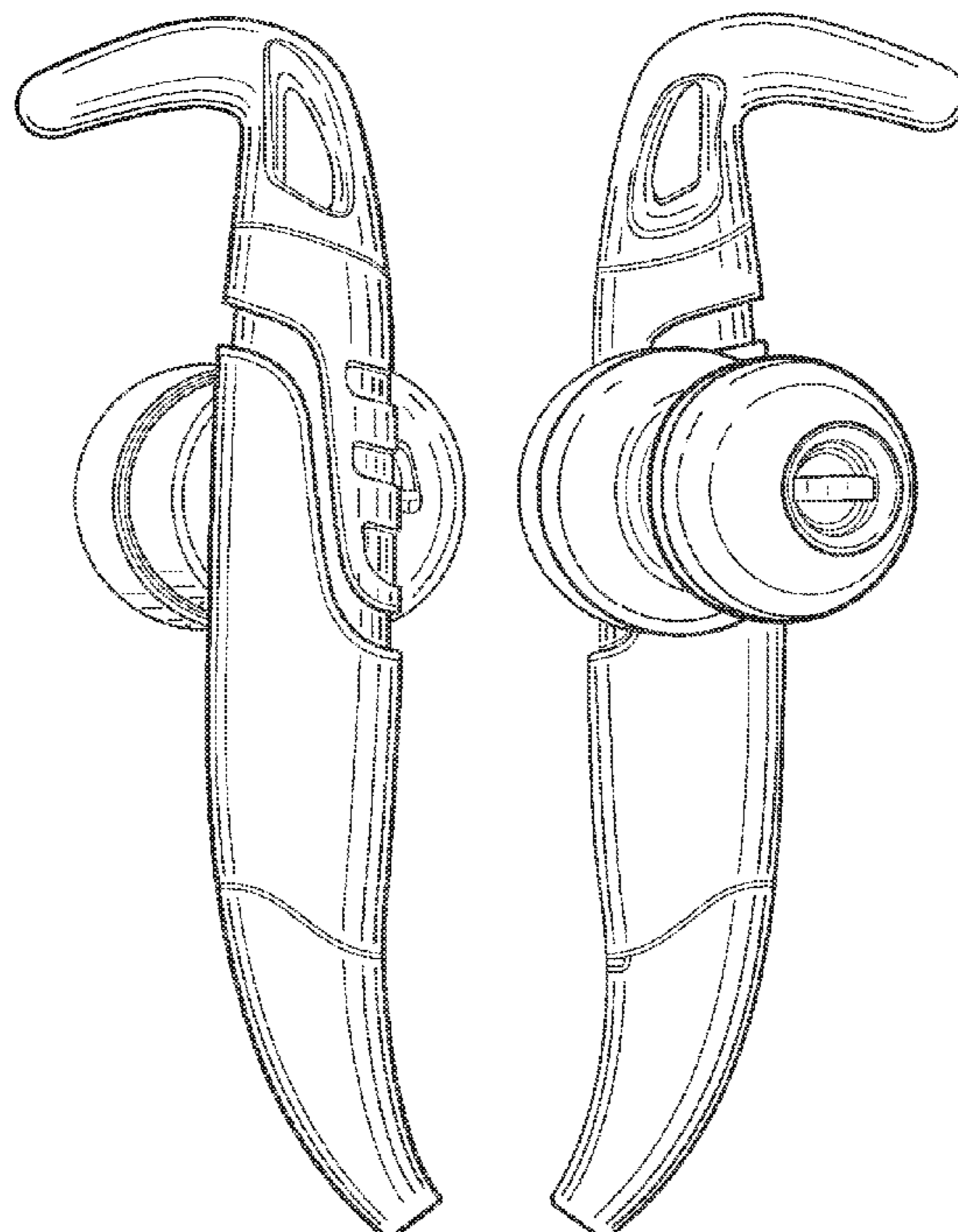

FIG. 1

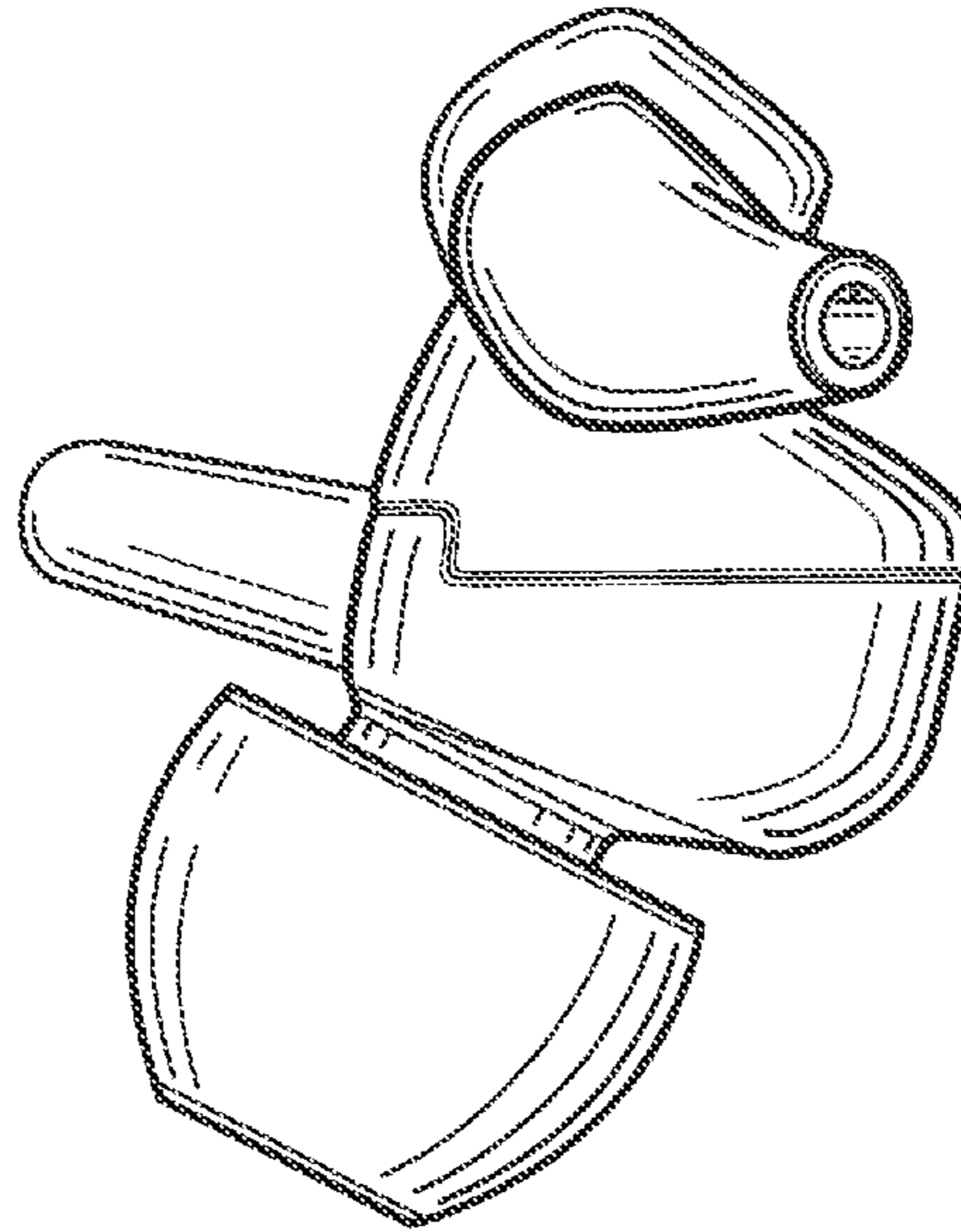

FIG. 2

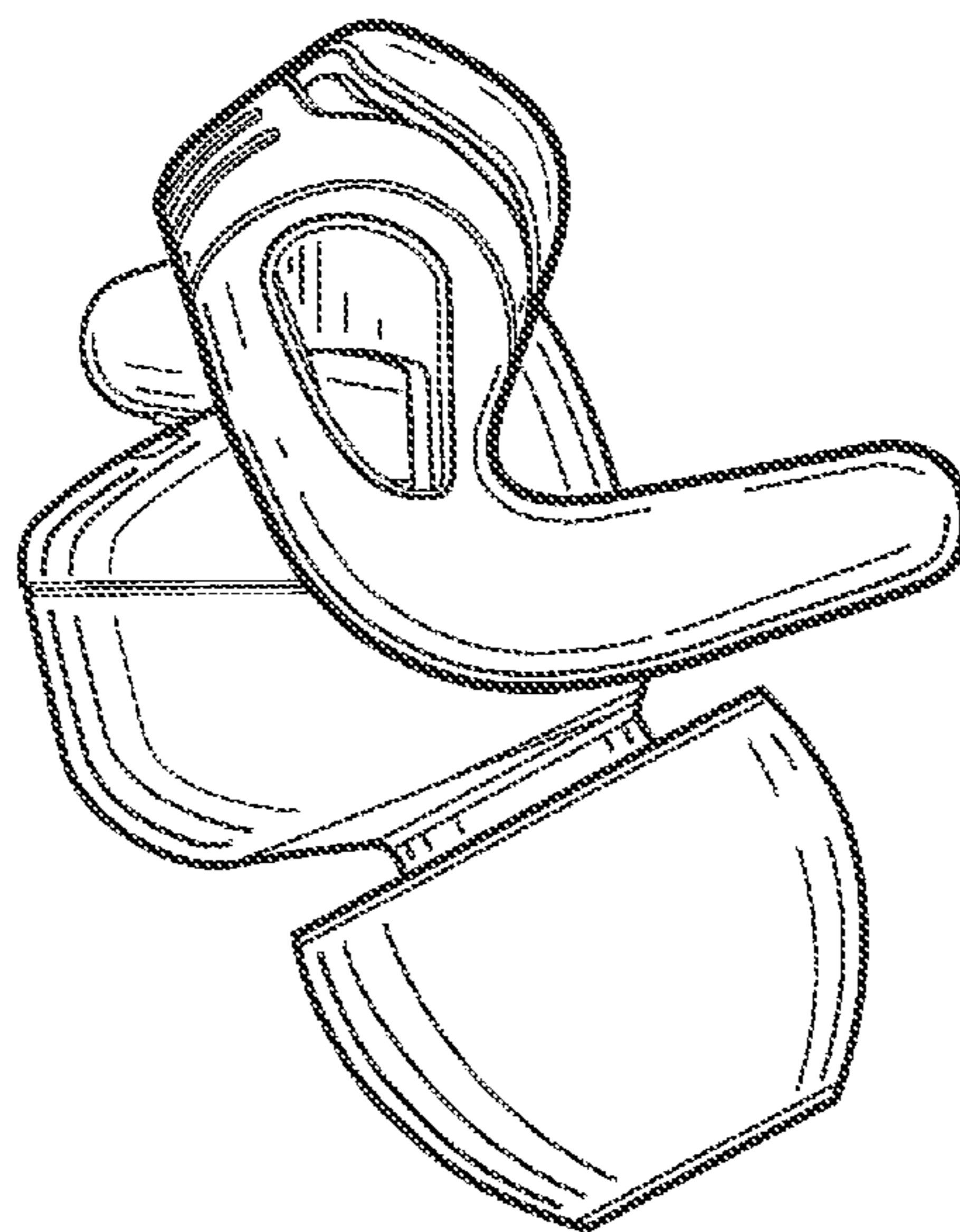

FIG. 3

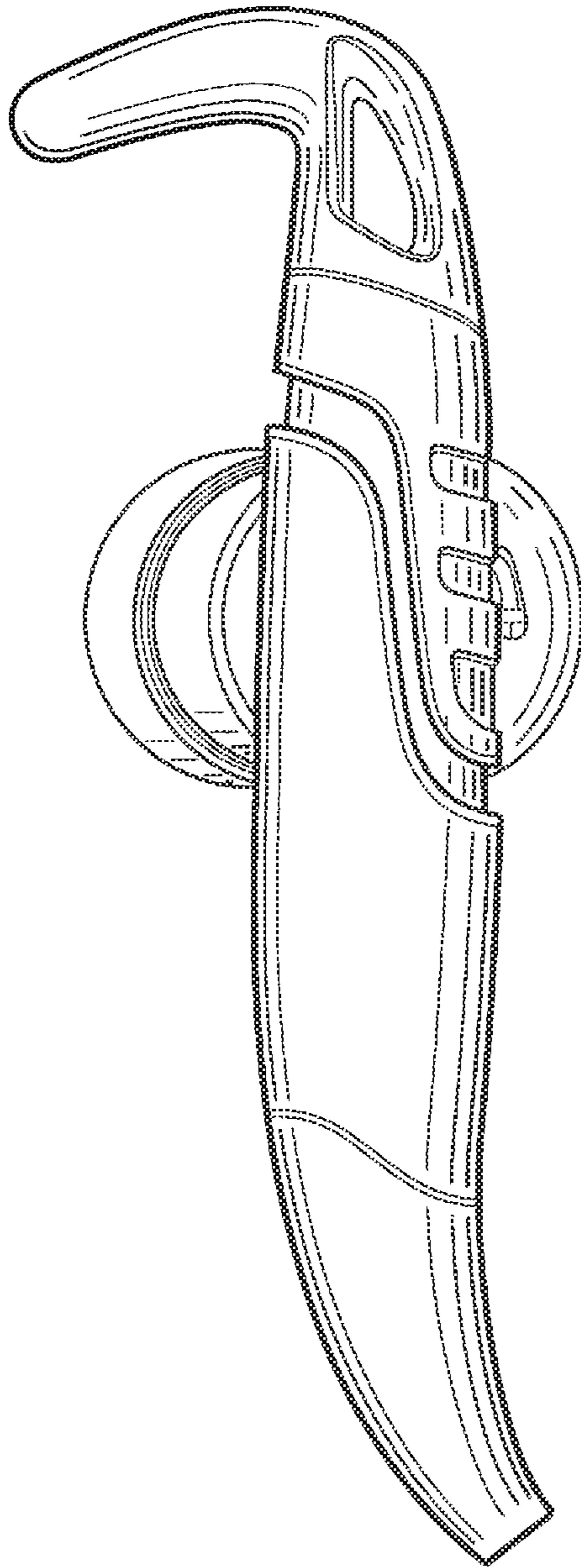

FIG. 4

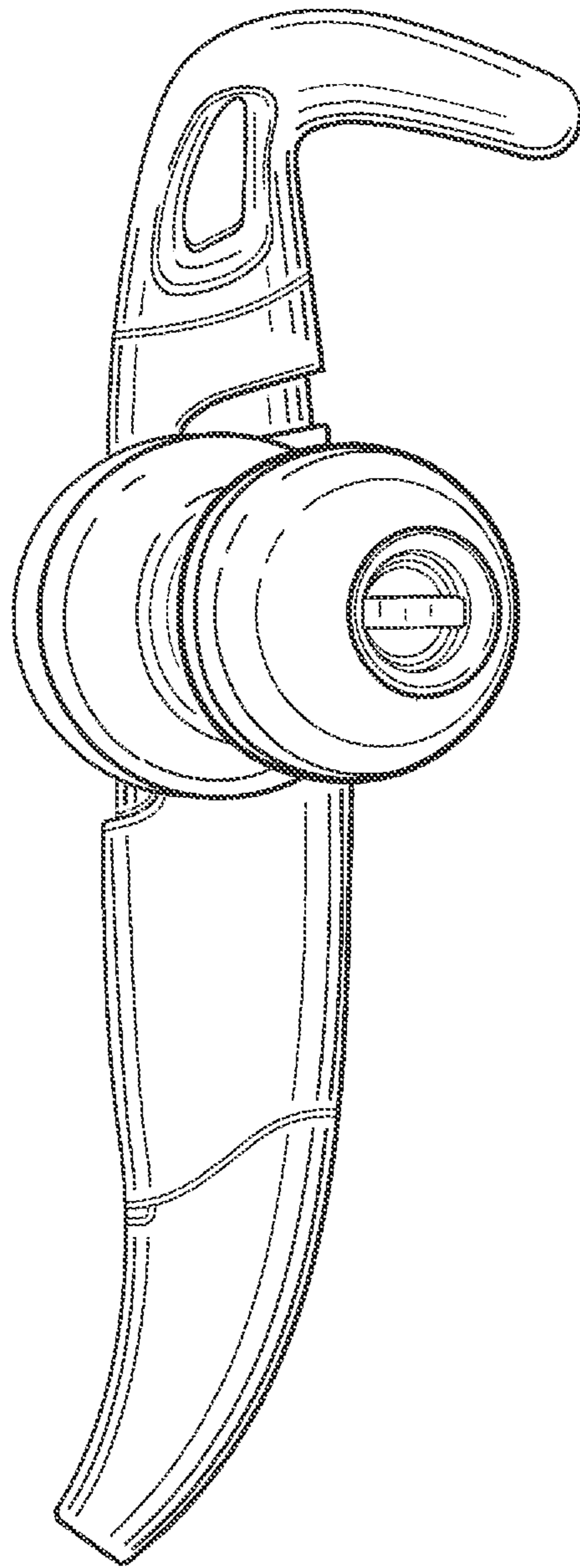

FIG. 5

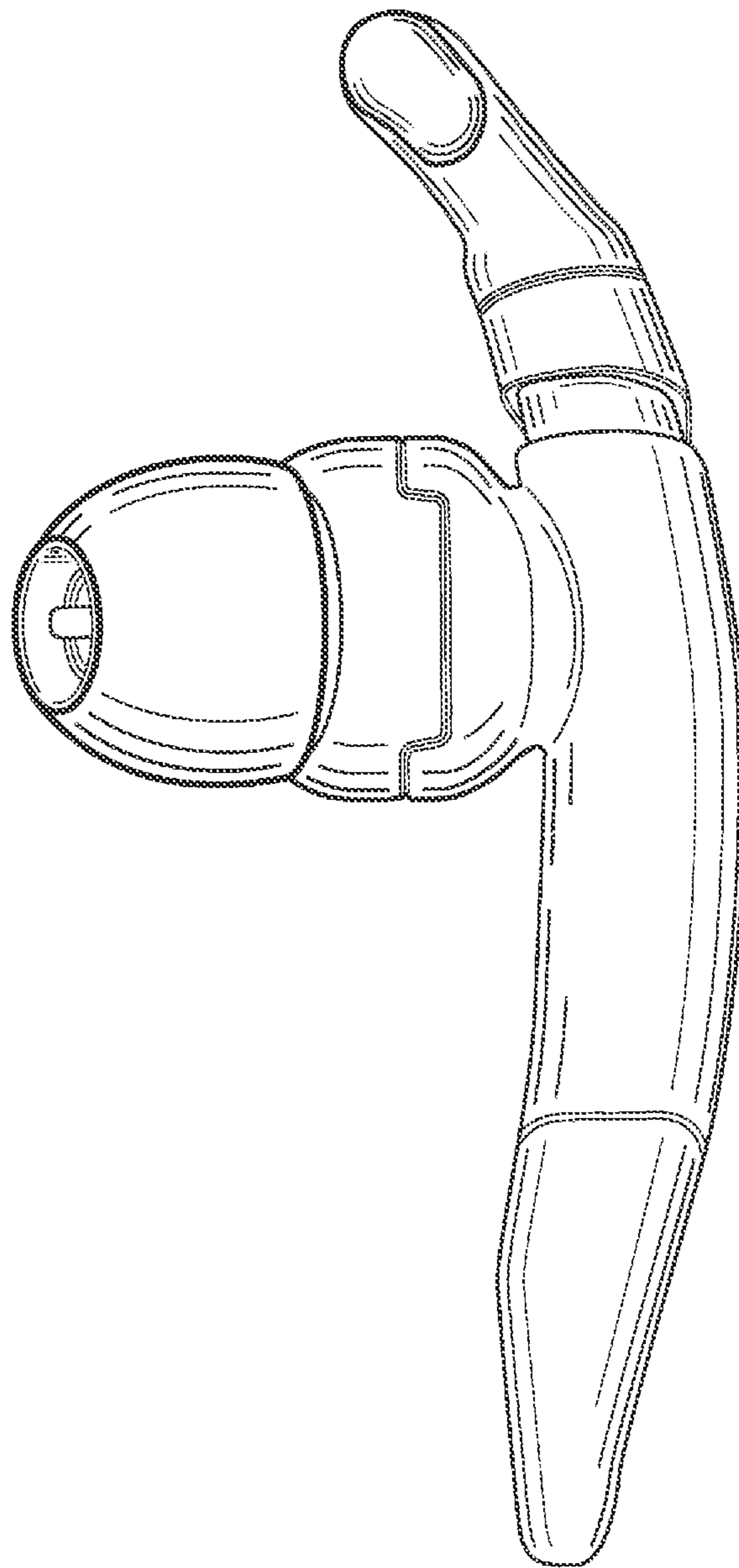

FIG. 6

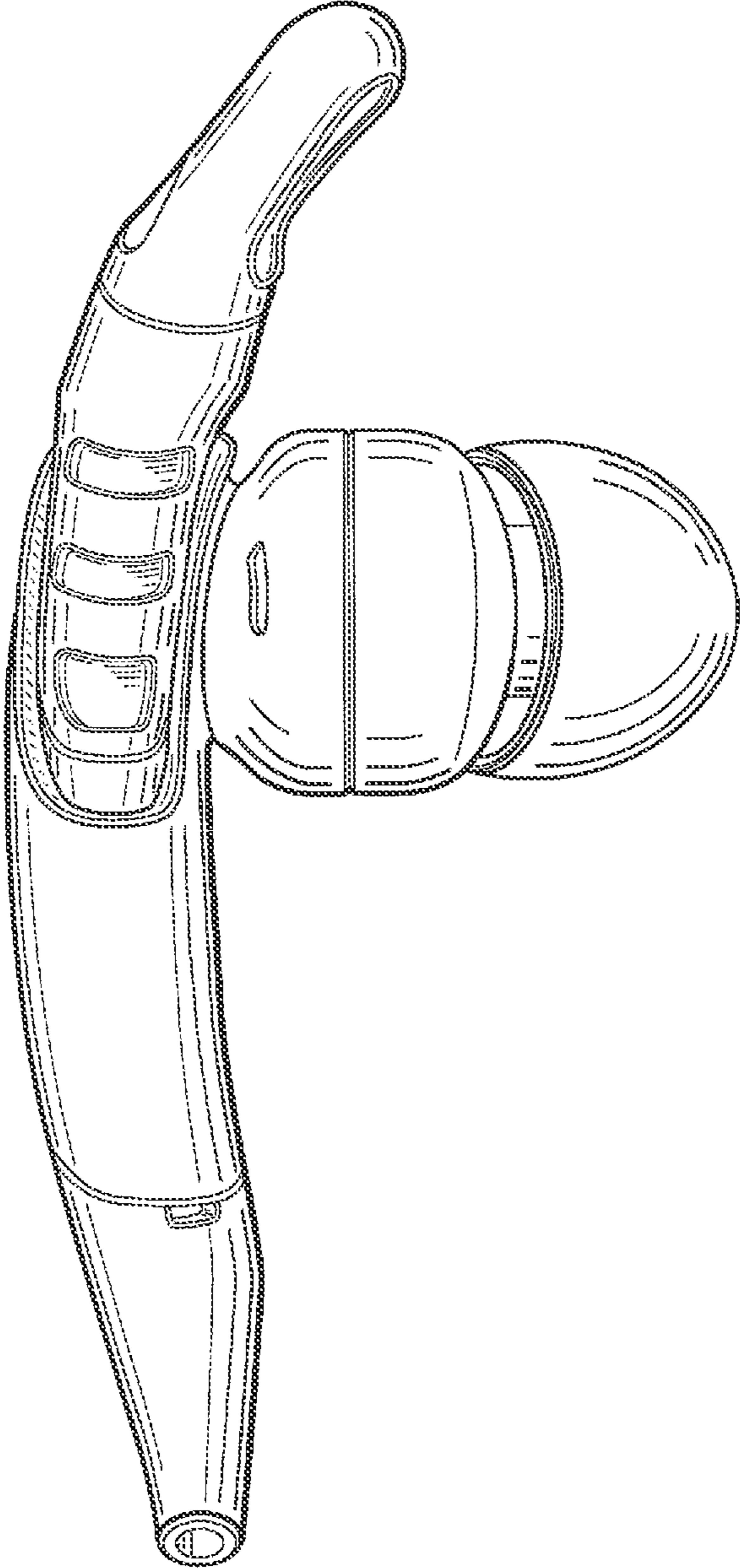

FIG. 7

