



US00D695701S

(12) **United States Design Patent**
Lee et al.

(10) **Patent No.:** **US D695,701 S**
(45) **Date of Patent:** **** Dec. 17, 2013**

(54) **TV RECEIVER**

273/148 B; 446/484, 175, 356; D10/15,
D10/26

(71) Applicants: **Sang-Young Lee**, Gwangmyeong (KR);
Jun-Ho Yang, Seongnam (KR);
Jae-Hyung Kim, Gwangju (KR)

See application file for complete search history.

(72) Inventors: **Sang-Young Lee**, Gwangmyeong (KR);
Jun-Ho Yang, Seongnam (KR);
Jae-Hyung Kim, Gwangju (KR)

(56) **References Cited**

(73) Assignee: **Samsung Electronics Co., Ltd.**,
Suwon-si, Gyeonggi-do (KR)

U.S. PATENT DOCUMENTS

(**) Term: **14 Years**

D460,425 S	7/2002	Joe	
D529,882 S	10/2006	Hoehn et al.	
D531,148 S	10/2006	Lin	
D627,750 S	11/2010	Suzuki	
D628,969 S	12/2010	Chien	
D639,256 S *	6/2011	Lee et al.	D14/126
D639,258 S	6/2011	Chien	
D652,810 S	1/2012	Park et al.	

(21) Appl. No.: **29/451,055**

* cited by examiner

(22) Filed: **Mar. 27, 2013**

Primary Examiner — Raphael Barkai

Related U.S. Application Data

(74) *Attorney, Agent, or Firm* — Flynn, Thiel, Boutell &
Tanis, P.C.

(63) Continuation of application No. 29/425,122, filed on
Jun. 20, 2012, now Pat. No. Des. 683,321.

(57) **CLAIM**

(30) **Foreign Application Priority Data**

The ornamental design for a TV receiver, as shown and
described.

Jan. 9, 2012 (KR) 30-2012-0001222

DESCRIPTION

(51) **LOC (9) Cl.** **14-03**

FIG. 1 is a top front perspective view of a TV receiver show-
ing my new design;

(52) **U.S. Cl.**
USPC **D14/126**

FIG. 2 is a front elevational view thereof;

(58) **Field of Classification Search**

FIG. 3 is a rear elevational view thereof;

USPC D14/125–134, 239, 371, 136, 374–377,
D14/440, 450, 448, 336, 342, 159; 312/7.2;
348/836, 838, 180, 184, 325, 739;
341/12; 248/917–924, 465; 345/104,
345/133, 156, 168, 87, 173; 720/605, 669,
720/600, 655; 369/99, 197; D21/329, 515,
D21/577, 622, 333, 433, 448, 452, 450,
D21/331; D6/477, 479, 300–310;

FIG. 4 is a left side elevational view thereof;

FIG. 5 is a right side elevational view thereof;

FIG. 6 is a top plan view thereof; and,

FIG. 7 is a bottom plan view thereof.

The broken lines depict environmental subject matter only
and form no part of the claimed design.

1 Claim, 4 Drawing Sheets

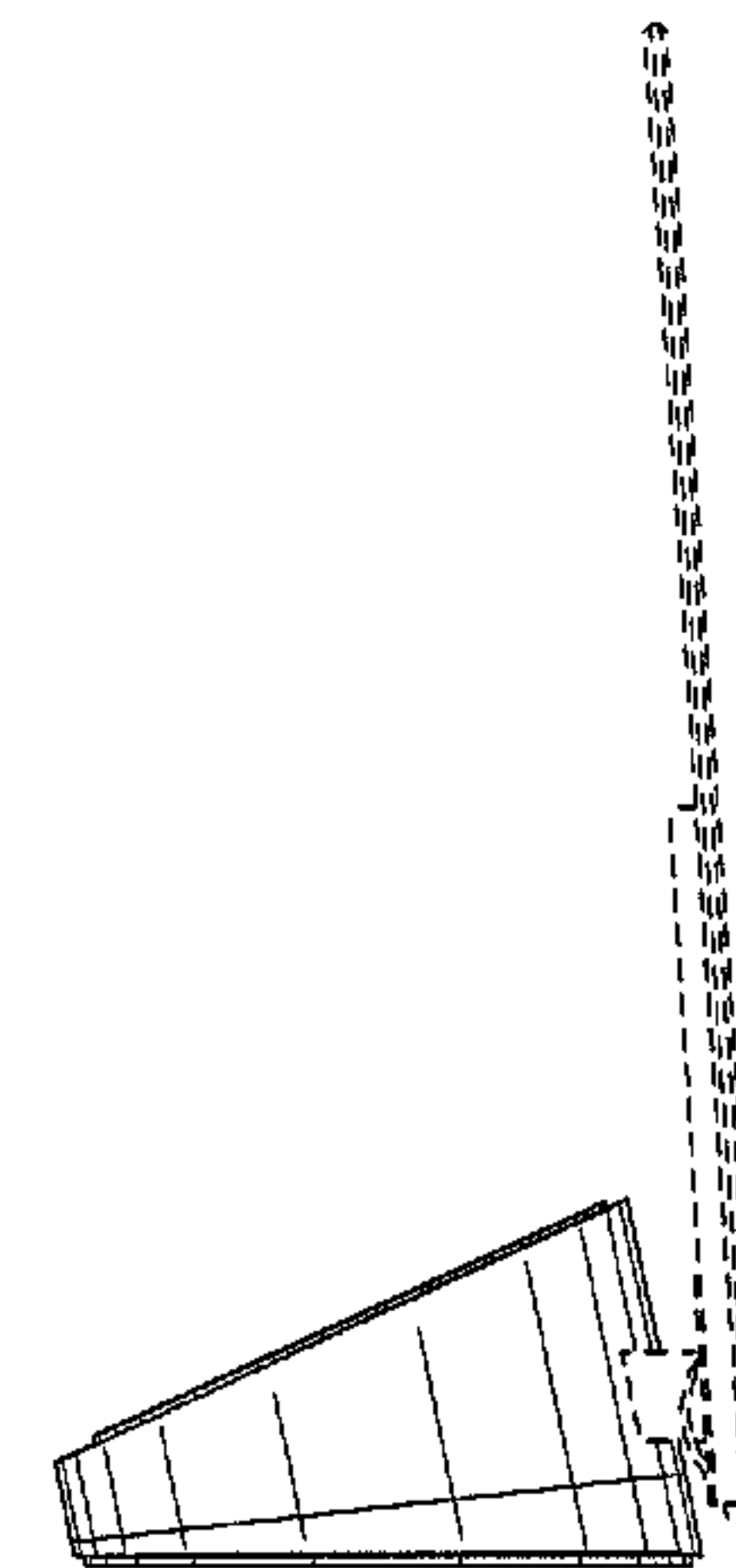
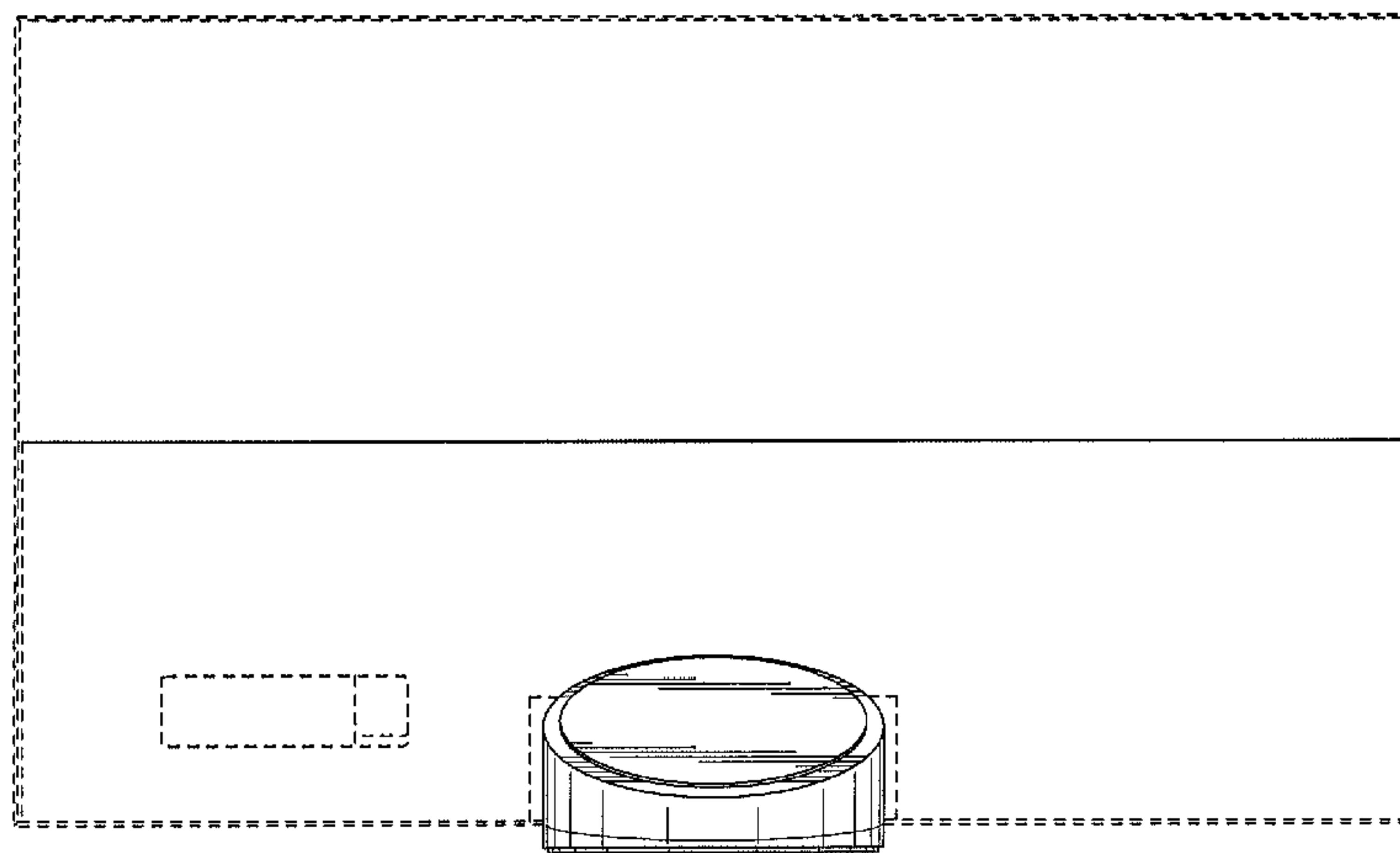

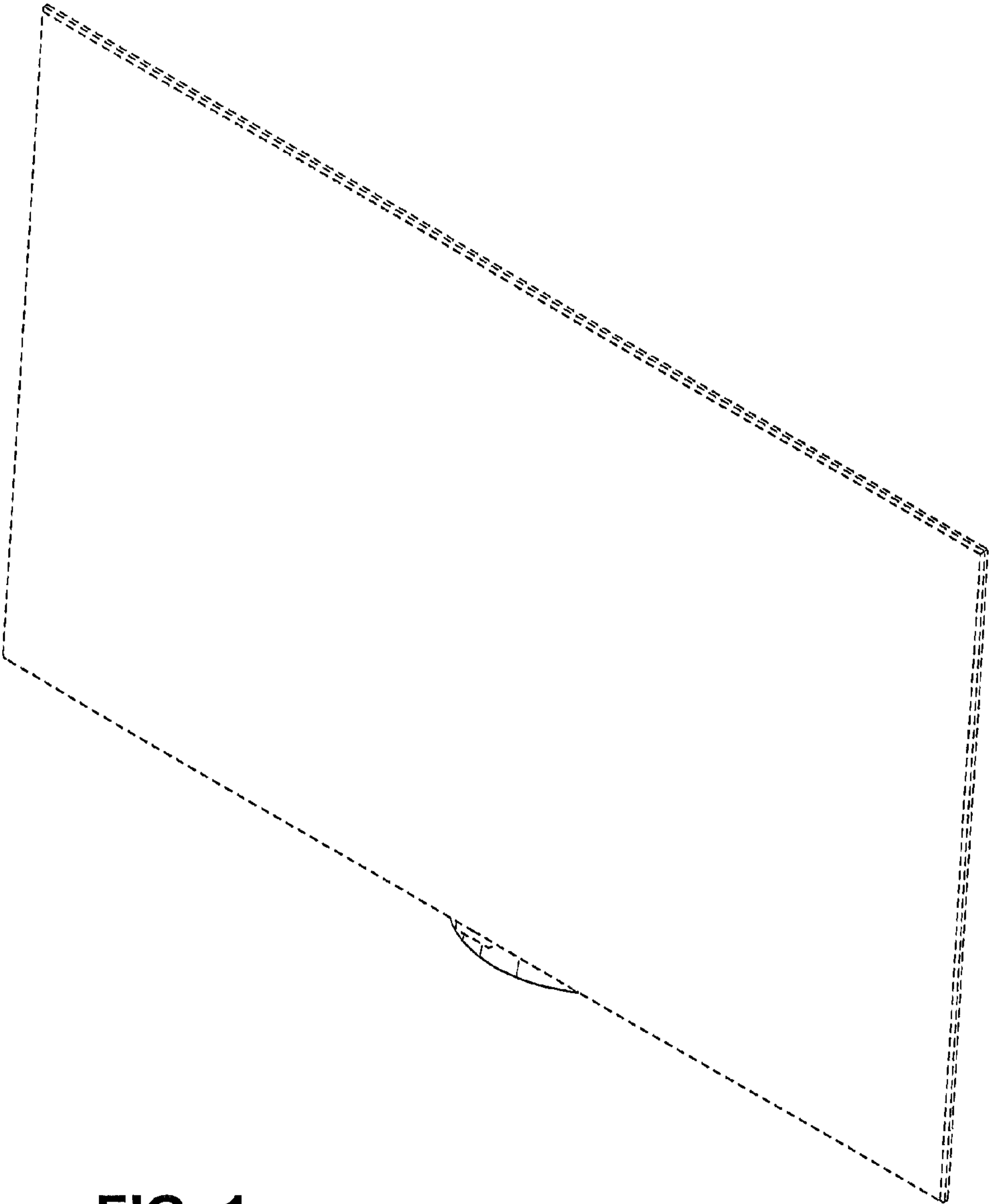

FIG. 1

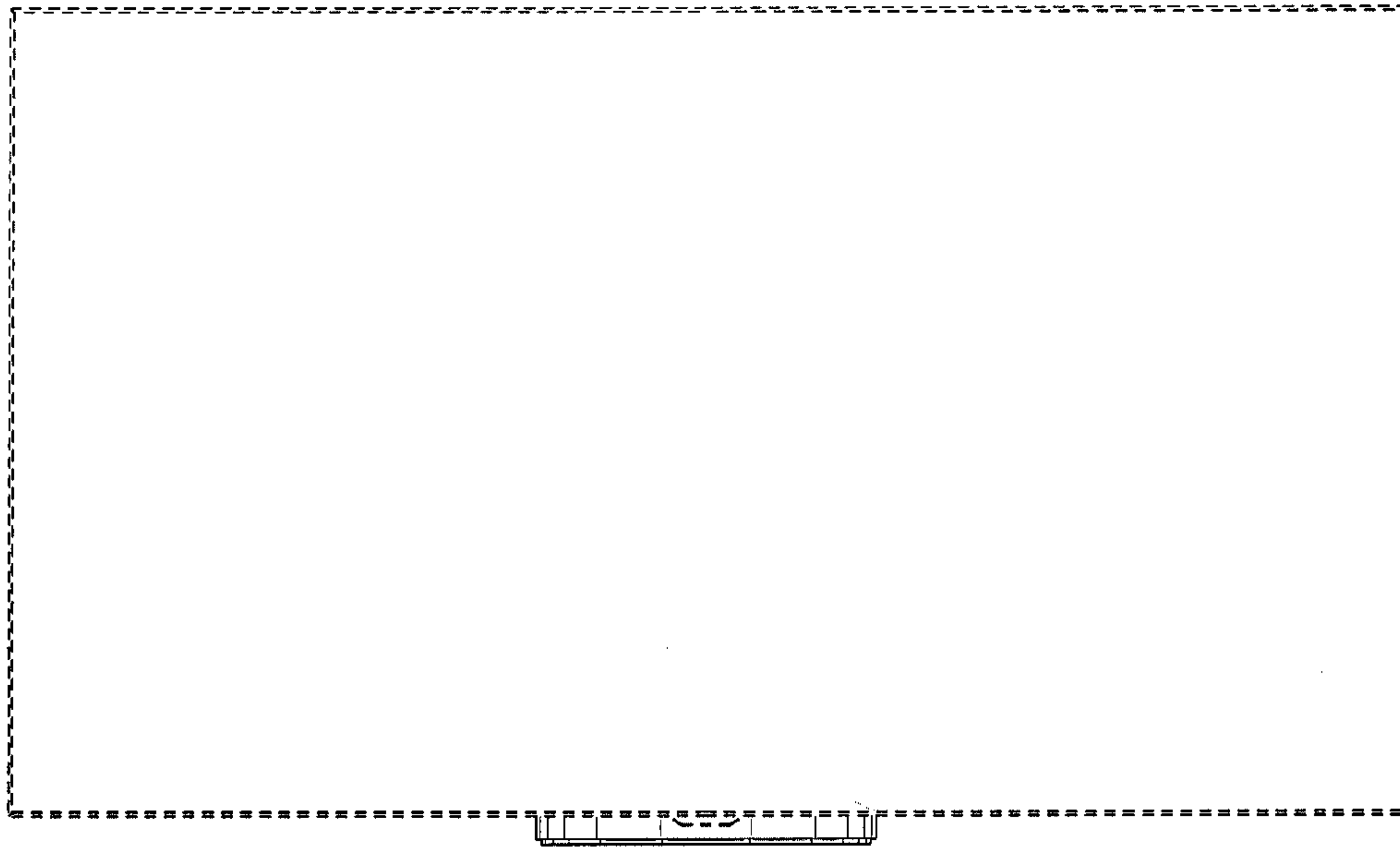

FIG. 2

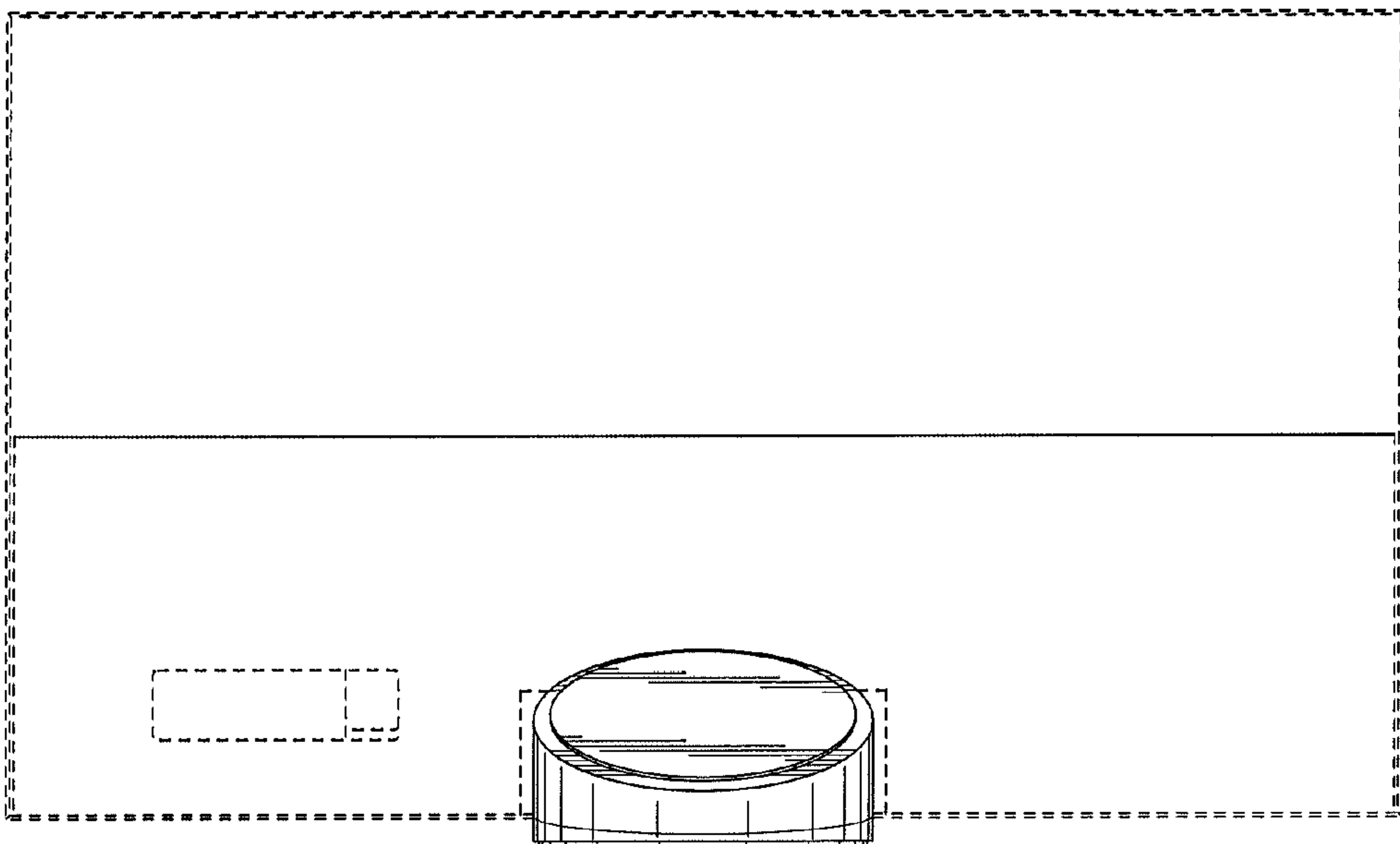

FIG. 3

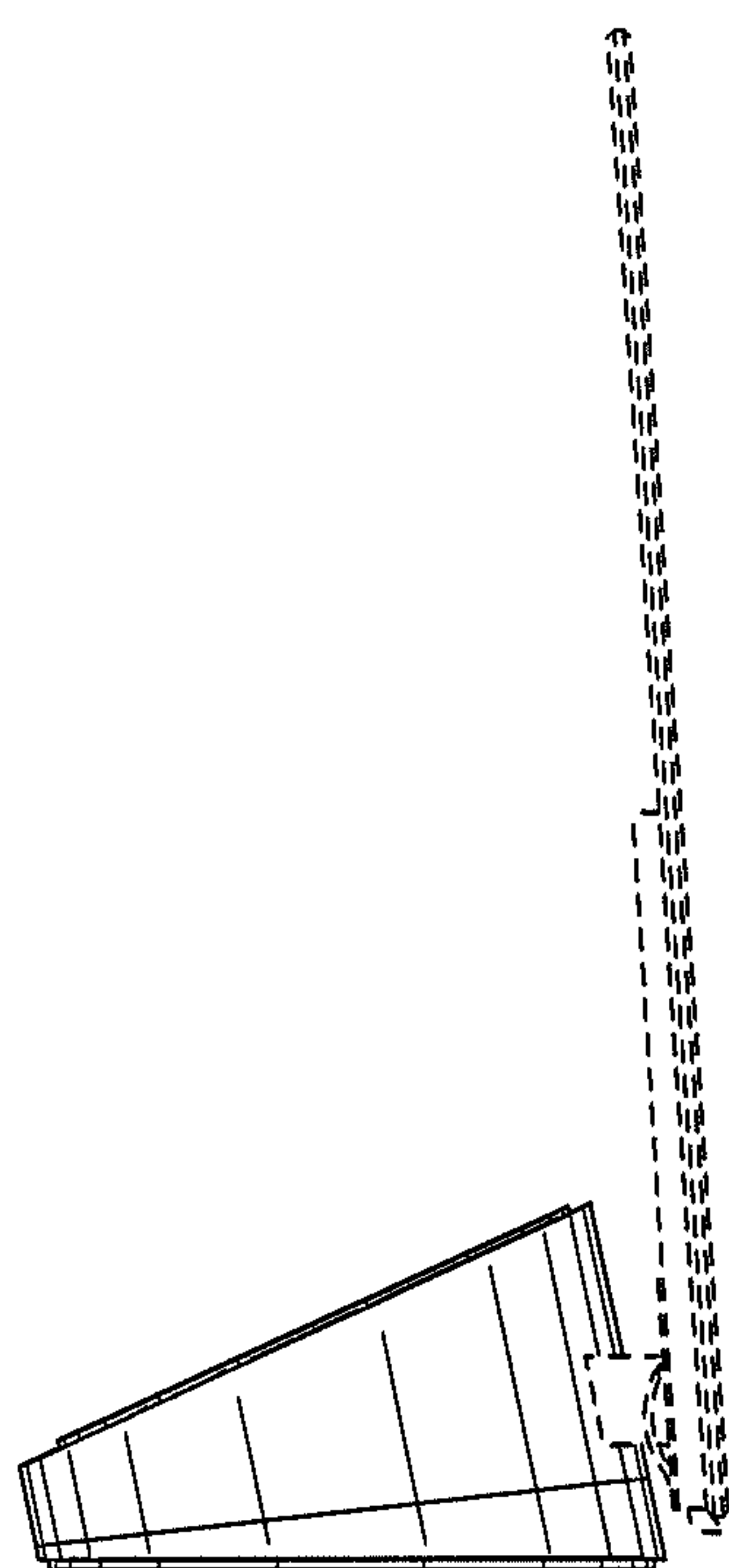

FIG. 4

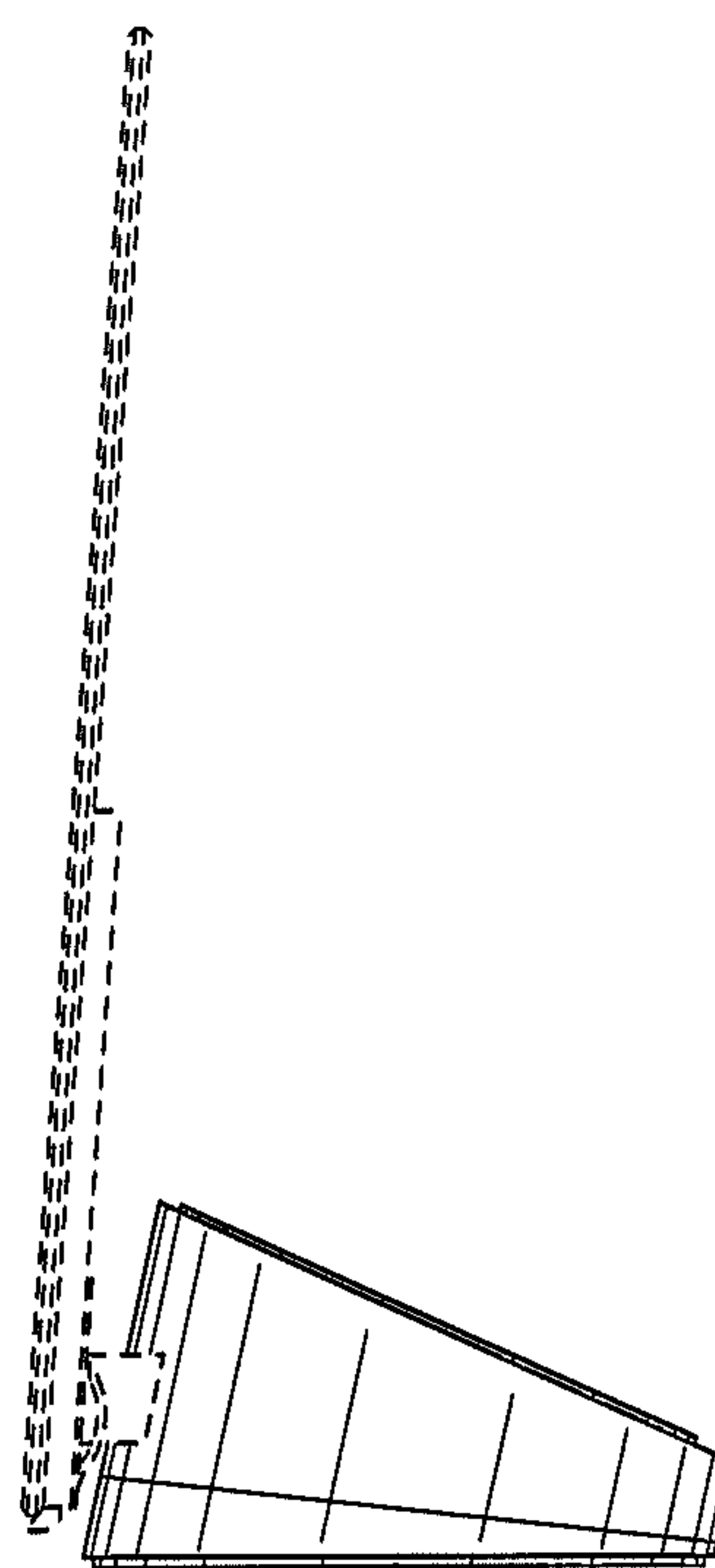

FIG. 5

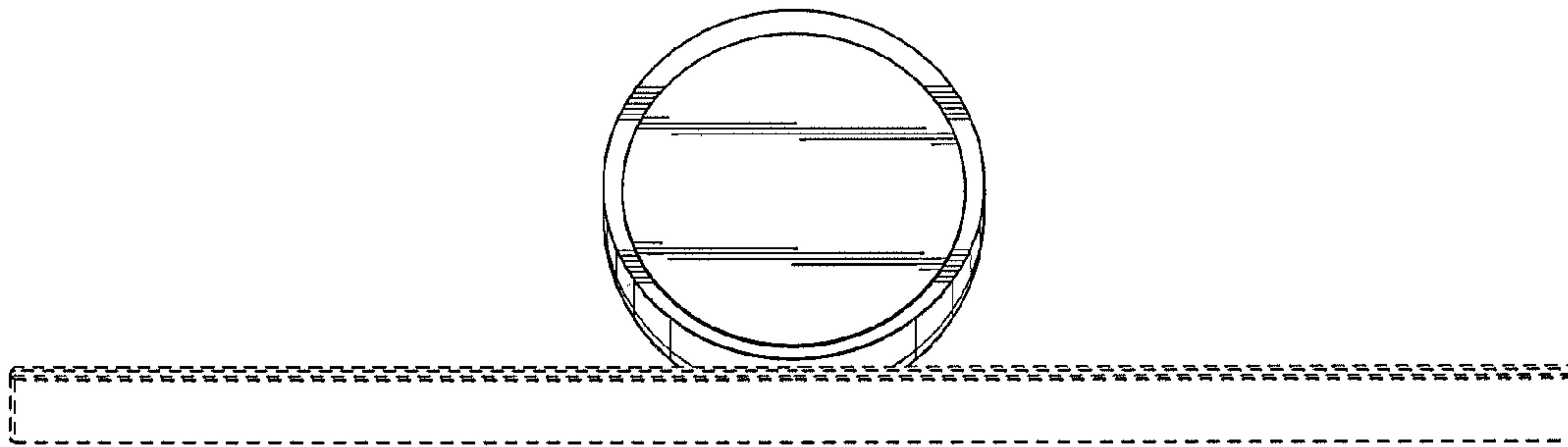

FIG. 6

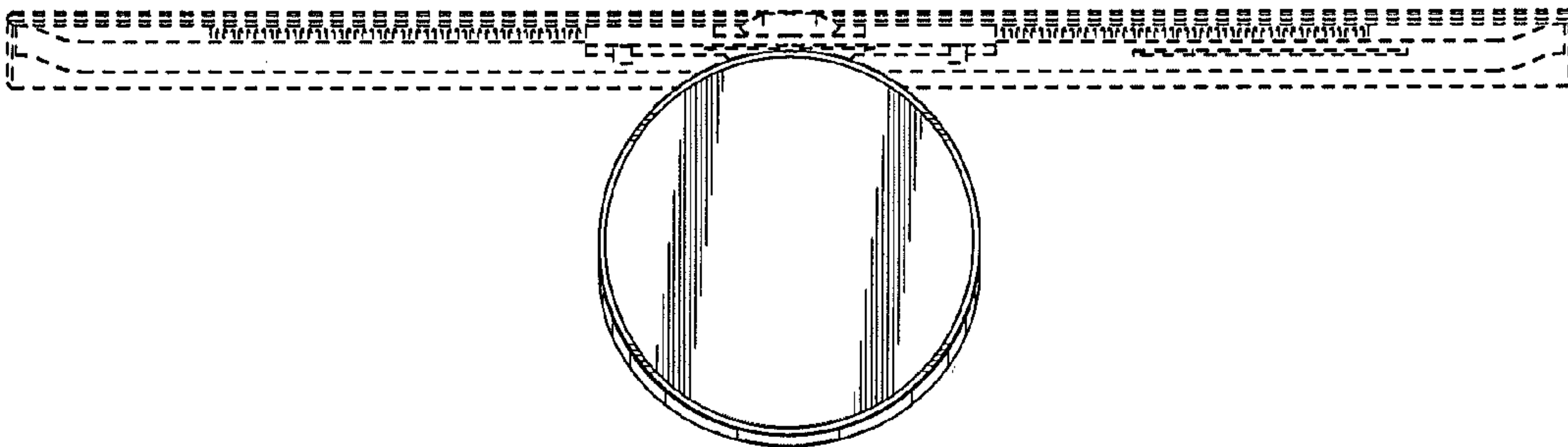

FIG. 7