

US00D695663S

(12) **United States Design Patent**
Suga et al.

(10) **Patent No.:** **US D695,663 S**

(45) **Date of Patent:** **** Dec. 17, 2013**

(54) **DOOR PANEL FOR AN AUTOMOBILE**

(75) Inventors: **Koichi Suga**, Toyota (JP); **Kenichi Hirai**, Toyota (JP); **Ken Billes**, Antibes (FR)

(73) Assignee: **Toyota Jidosha Kabushiki Kaisha** (JP)

(**) Term: **14 Years**

(21) Appl. No.: **29/425,598**

(22) Filed: **Jun. 25, 2012**

(51) **LOC (9) Cl.** **12-16**

(52) **U.S. Cl.**
USPC **D12/196**

(58) **Field of Classification Search**
USPC D12/196, 90-92, 86; 296/181.1, 181.5
See application file for complete search history.

(56) **References Cited**

U.S. PATENT DOCUMENTS

D245,975 S *	10/1977	Tixier	D12/196
D309,287 S *	7/1990	Envall et al.	D12/196
D312,804 S *	12/1990	Okano	D12/196
D420,964 S *	2/2000	Sacco et al.	D12/196
D442,131 S *	5/2001	Pfeiffer	D12/196
D479,700 S *	9/2003	Boyer	D12/196
7,111,894 B2 *	9/2006	Kora et al.	296/146.1
D556,111 S *	11/2007	Levy	D12/196
D598,355 S *	8/2009	Sato et al.	D12/196
D653,596 S *	2/2012	Tomatsu et al.	D12/196
D659,619 S *	5/2012	Hakamata et al.	D12/196
D659,622 S *	5/2012	Matsumoto et al.	D12/196
D674,328 S *	1/2013	Ikuma et al.	D12/196
D686,957 S *	7/2013	Kwon et al.	D12/196

OTHER PUBLICATIONS

Citroen, Citroen C4, NetCarShow.com, http://www.netcarshow.com/citroen/2011-c4/800x600/wallpaper_2b.htm, available at least as early as Jun. 25, 2011.

Mazda, Mazda 3, NetCarShow.com, http://www.netcarshow.com/mazda/2010-3_i-stop/800x600/wallpaper_04.htm, available at least as early as Jun. 25, 2011.

Renault, Renault Megane, NetCarShow.com, http://www.netcarshow.com/renault/2009-megane/800x600/wallpaper_od.htm, available at least as early as Jun. 25, 2011.

BMW, BMW 3 series touring, NetCarShow.com, http://www.netcarshow.com/bmw/2009-3-series_touring/800x600/wallpaper_09.htm, available at least as early as Jun. 25, 2011.

Opel, Opel Astra Tourer, NetCarShow.com, http://www.netcarshow.com/opel/2011-astra_sports_tourer/800x600/wallpaper_1b.htm, available at least as early as Jun. 25, 2011.

Ford, Ford Focus Estate, NetCarShow.com, http://www.netcarshow.com/ford/2011-focus_estate/800x600/wallpaper_08.htm, available at least as early as Jun. 25, 2011.

* cited by examiner

Primary Examiner — Melody Brown

(74) *Attorney, Agent, or Firm* — SAIDMAN DesignLaw Group

(57) **CLAIM**

The ornamental design for a door panel for an automobile, as shown and described.

DESCRIPTION

FIG. 1 is a front, perspective view of a door panel for an automobile showing our new design;
FIG. 2 is a rear, perspective view thereof;
FIG. 3 is a front view thereof;
FIG. 4 is a rear view thereof;
FIG. 5 is a top view thereof;
FIG. 6 is a bottom view thereof;
FIG. 7 is a right side view thereof; and,
FIG. 8 is a left side view thereof.

1 Claim, 6 Drawing Sheets

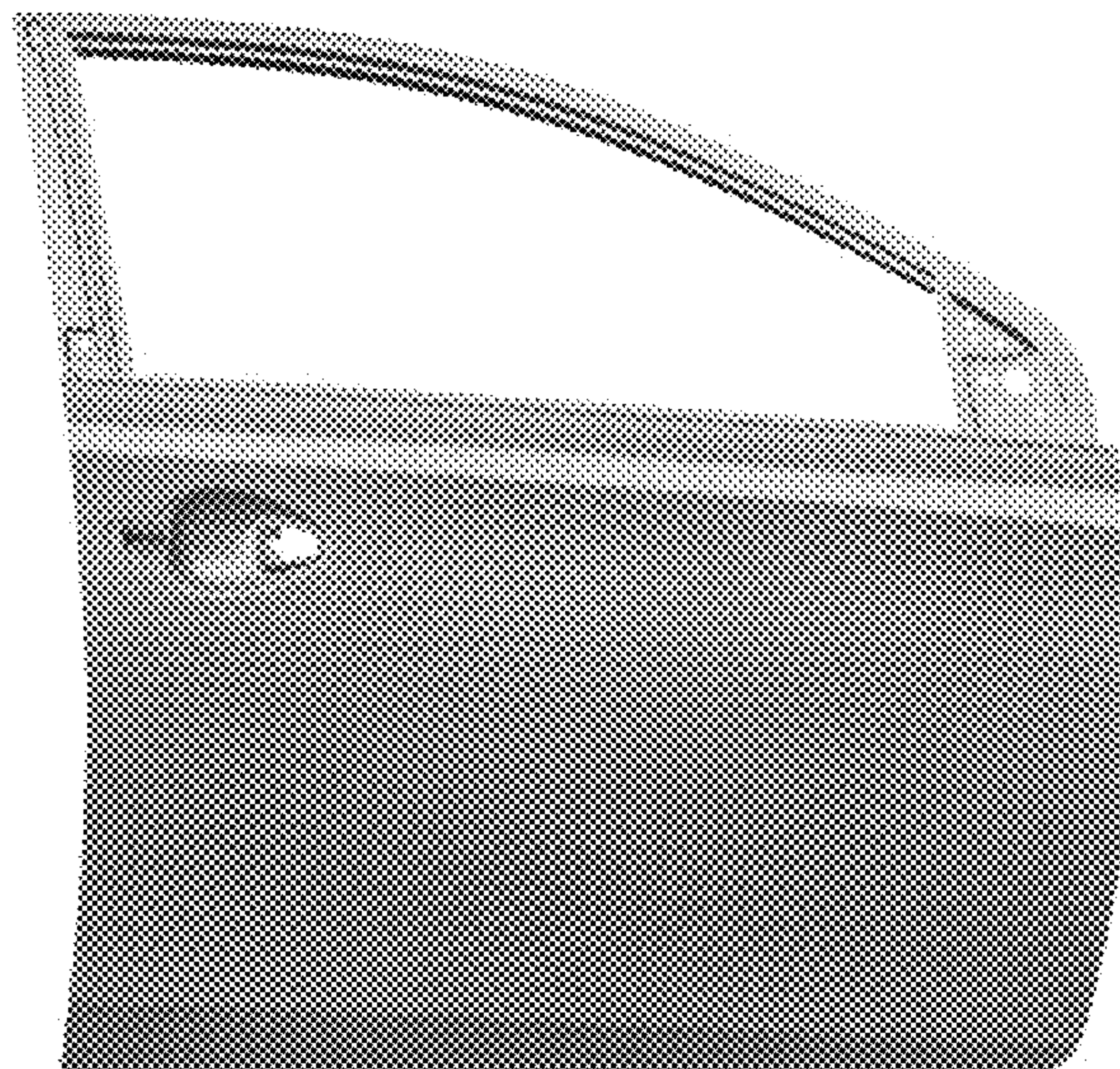

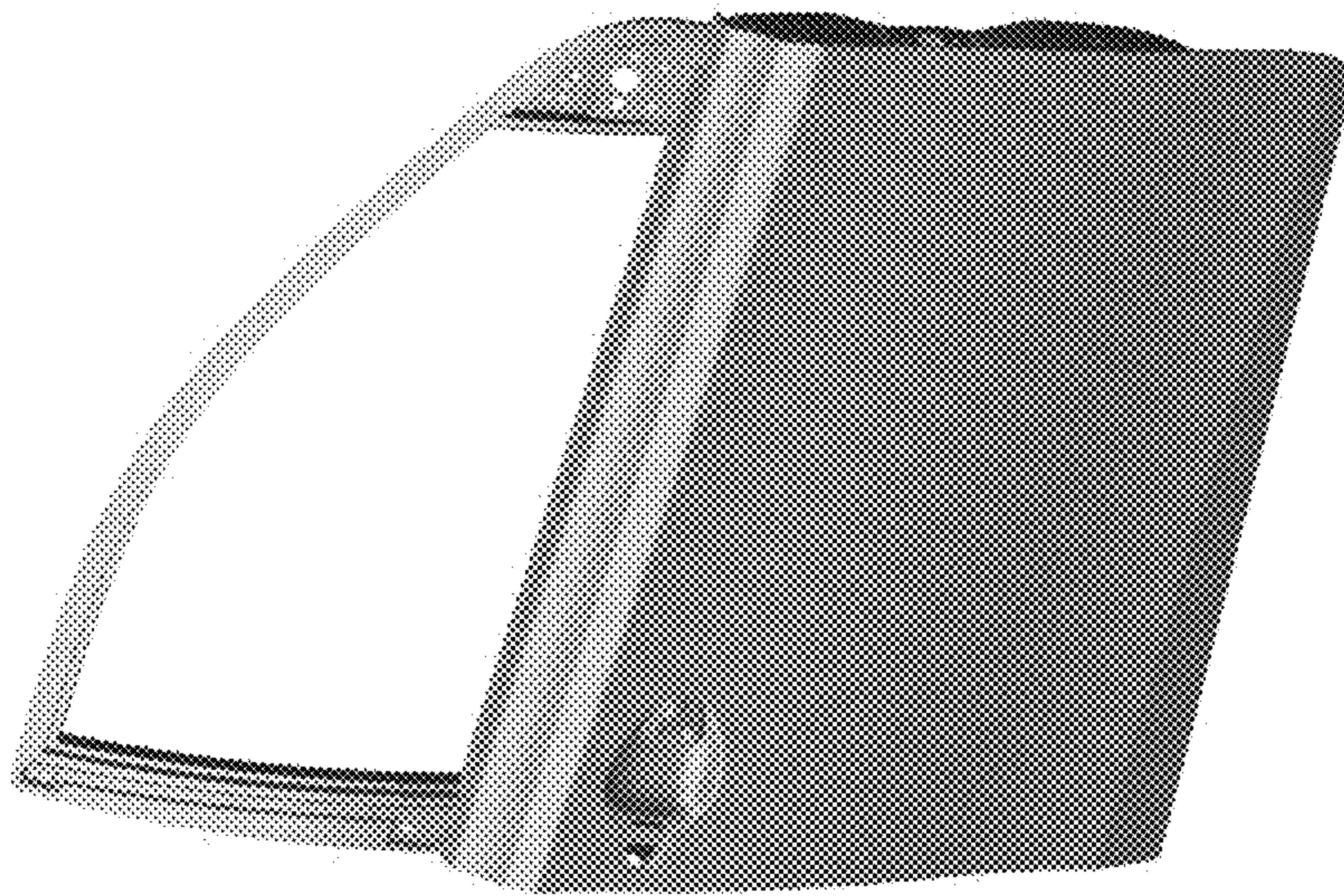

FIG. 1

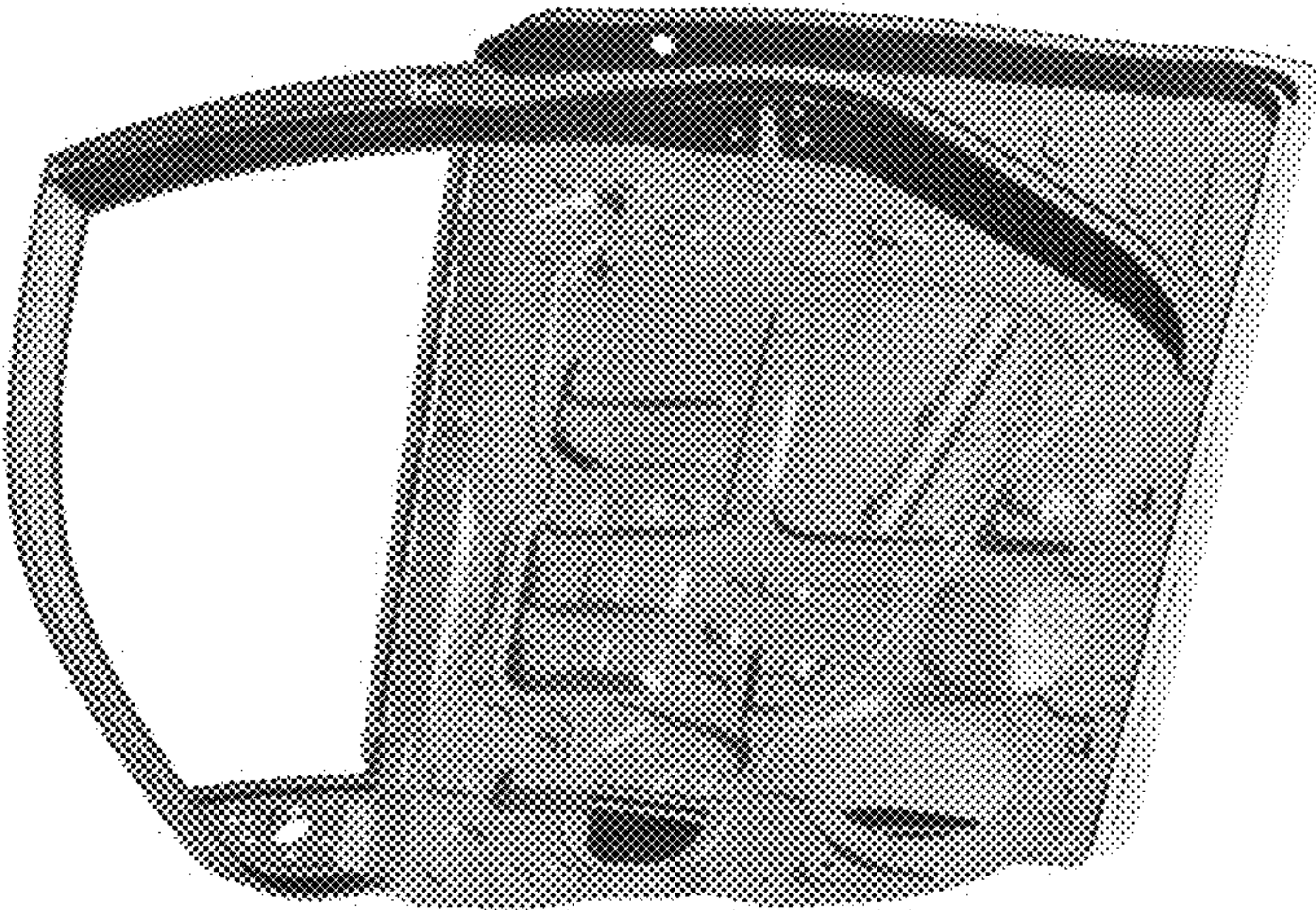

FIG. 2



FIG. 3

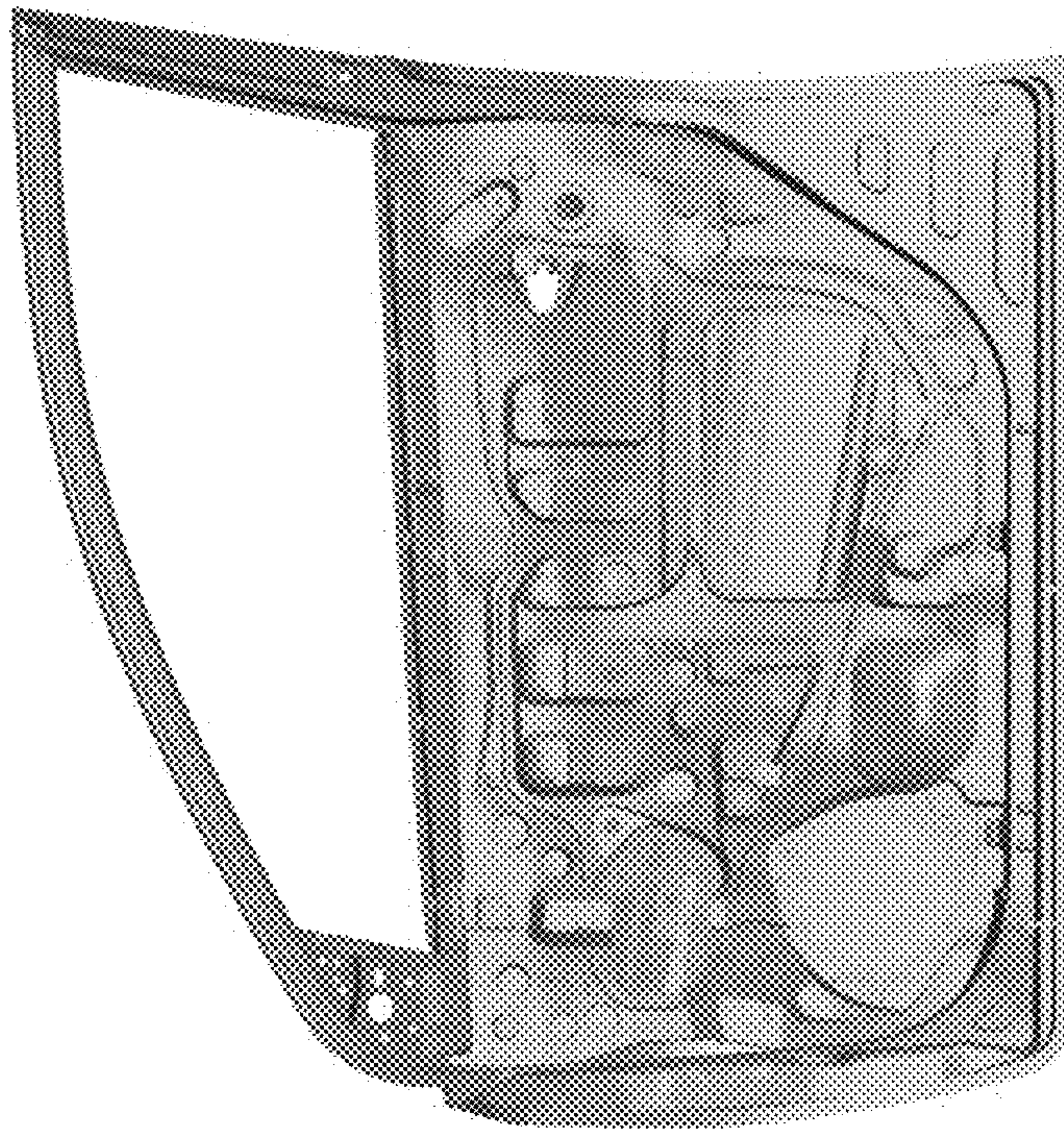

FIG. 4

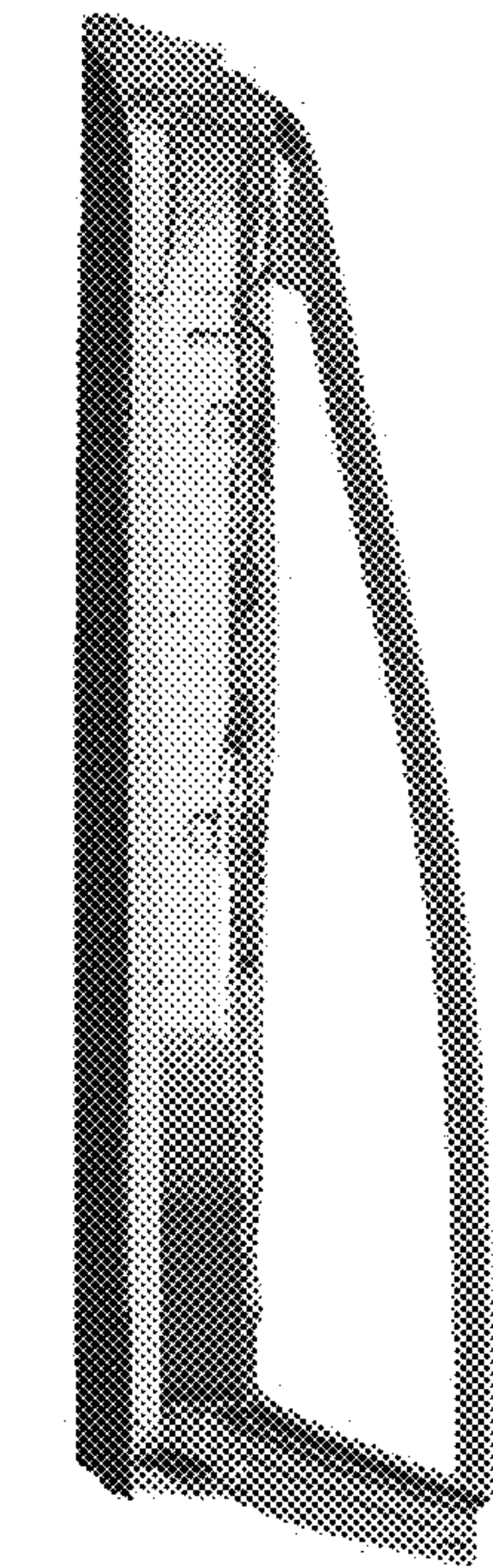

FIG. 6

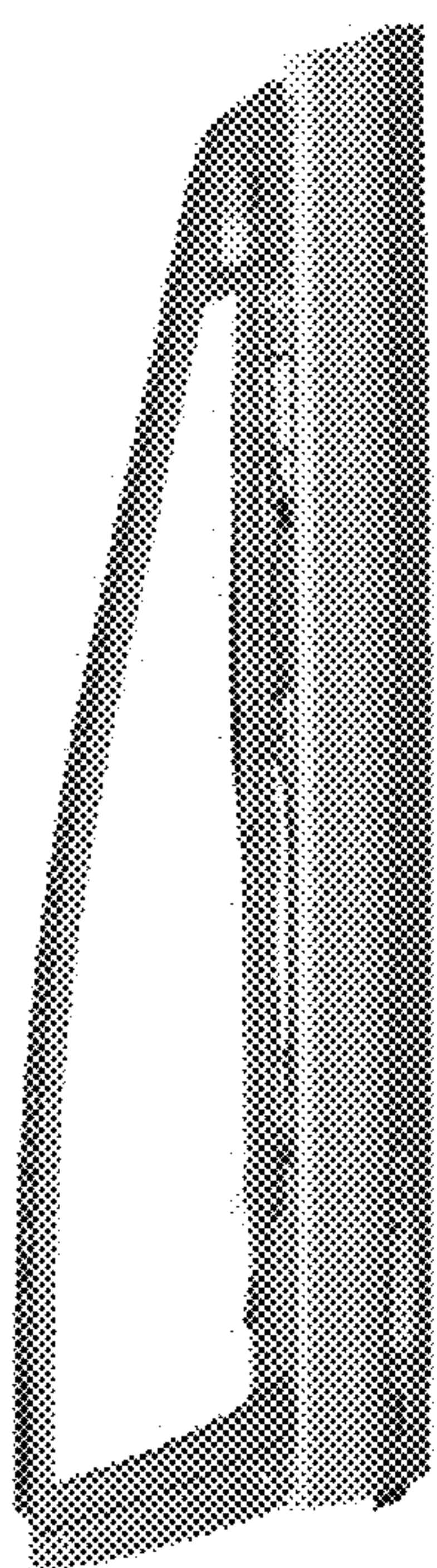

FIG. 5



FIG. 8

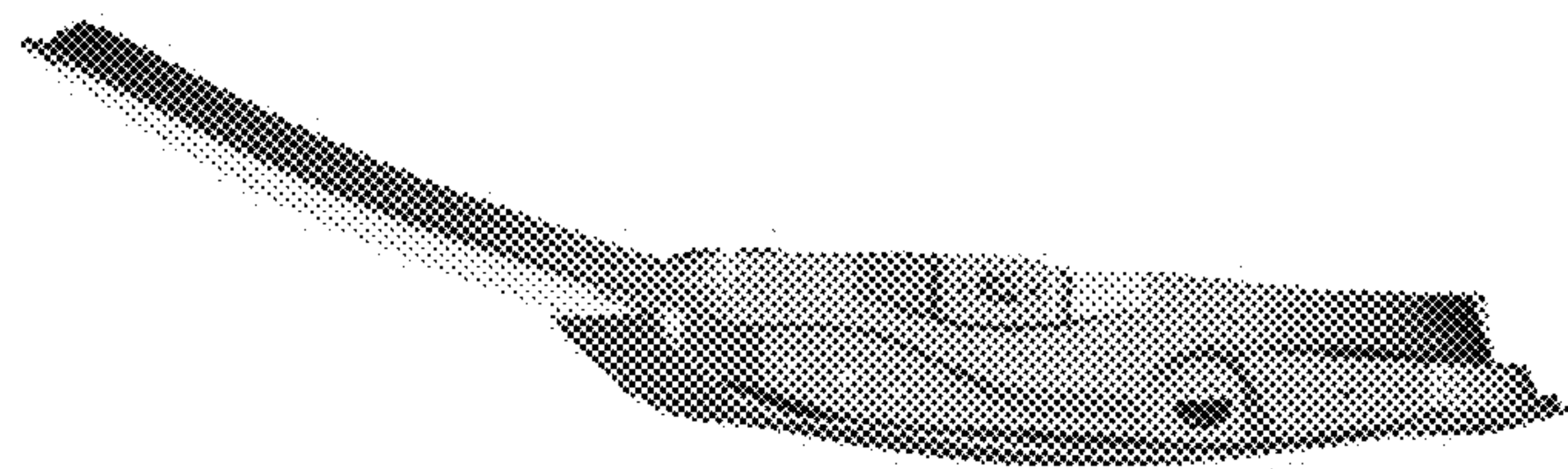

FIG. 7