



US00D695650S

(12) **United States Design Patent**
Cho

(10) **Patent No.:** **US D695,650 S**

(45) **Date of Patent:** **** Dec. 17, 2013**

(54) **FRAME OF A BICYCLE**

(75) Inventor: **Yun Ju Cho**, Gyeonggi-do (KR)

(73) Assignee: **Mando Corporation**, Pyeongtaek-Si (KR)

(**) Term: **14 Years**

(21) Appl. No.: **29/420,174**

(22) Filed: **May 4, 2012**

(30) **Foreign Application Priority Data**

Apr. 12, 2012 (KR) 30-2012-0017147

(51) **LOC (9) Cl.** **12-11**

(52) **U.S. Cl.**
USPC **D12/111**

(58) **Field of Classification Search**

USPC D12/111, 117, 119; 280/274–280,
280/281.1, 283–288, 288.1–288.3

See application file for complete search history.

(56) **References Cited**

U.S. PATENT DOCUMENTS

6,032,971	A *	3/2000	Herder	280/278
6,267,401	B1 *	7/2001	De Jong	280/287
6,688,625	B1 *	2/2004	Schreuder et al.	280/260
D487,234	S *	3/2004	Chen et al.	D12/111
6,764,090	B1 *	7/2004	Pan	280/278
D494,508	S *	8/2004	Liu	D12/111
D497,574	S *	10/2004	Yamabe	D12/111
D547,702	S *	7/2007	Tabuchi et al.	D12/111
D643,785	S *	8/2011	Kyu	D12/111

* cited by examiner

Primary Examiner — Susan M Lee

Assistant Examiner — Linda Brooks

(74) *Attorney, Agent, or Firm* — McDermott Will & Emery LLP

(57) **CLAIM**

The ornamental design for a frame of a bicycle, as shown and described.

DESCRIPTION

FIG. 1 is a front/right-side/top perspective view of a frame for bicycle showing my new design;

FIG. 2 is a front elevational view thereof;

FIG. 3 is a rear elevational view thereof;

FIG. 4 is a left-side elevational view thereof;

FIG. 5 is a right-side elevational view thereof;

FIG. 6 is a top-side plan view thereof;

FIG. 7 is a bottom-side plan view thereof;

FIG. 8 is a front/right-side/top perspective view showing a frame of a bicycle folded;

FIG. 9 is a front elevational view thereof;

FIG. 10 is a rear elevational view thereof;

FIG. 11 is a left-side elevational view thereof;

FIG. 12 is a right-side elevational view thereof;

FIG. 13 is a top-side plan view thereof; and,

FIG. 14 is a bottom-side plan view thereof.

The surface treatment of the frame for bicycle shown in the figures forms no part of the claimed design, a frame for bicycle according to the claimed design may have any surface treatment.

The inventor contemplates that other embodiments of their design may include any part, portion, element or combination of elements of the claimed design.

1 Claim, 14 Drawing Sheets

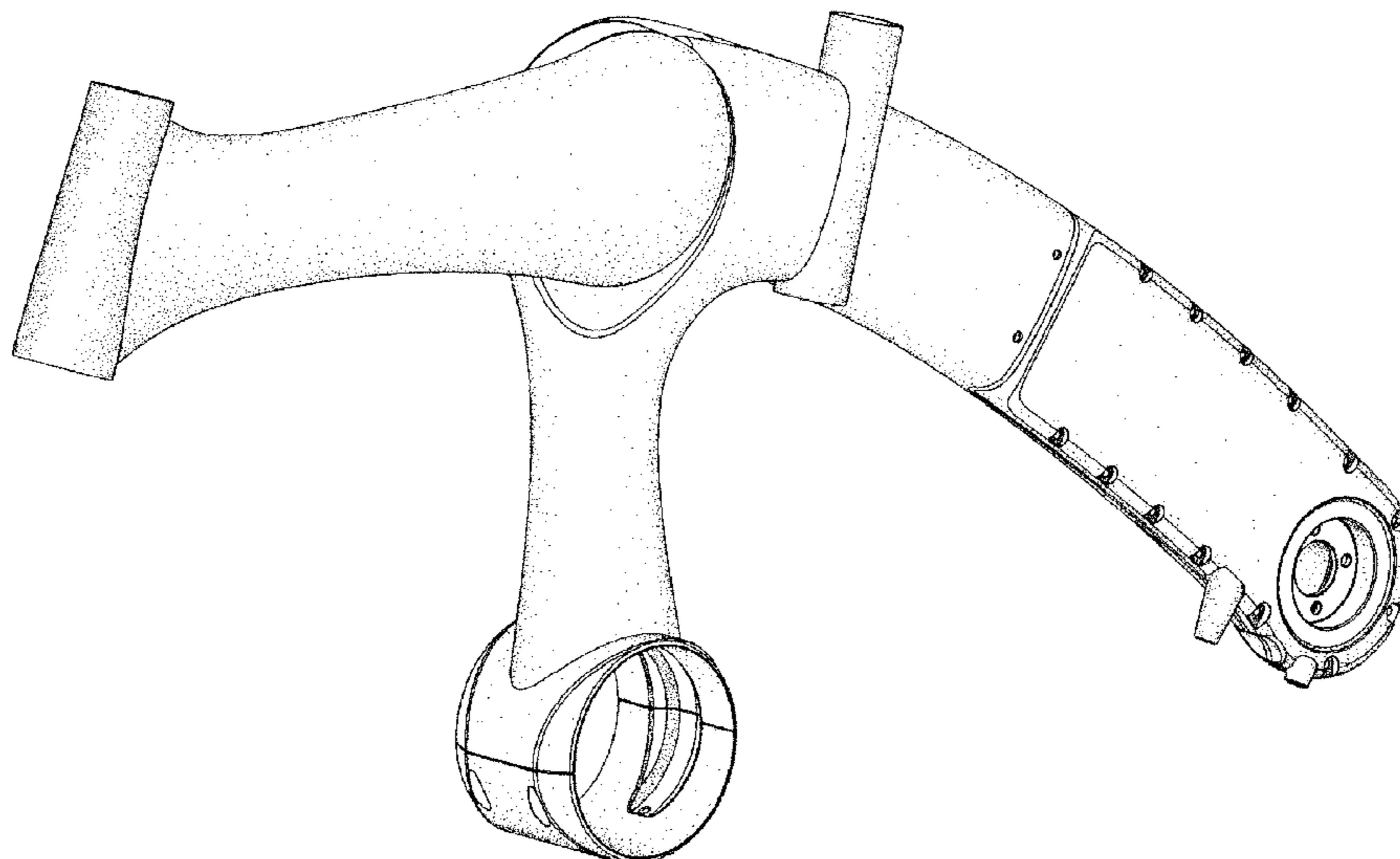

FIG. 1

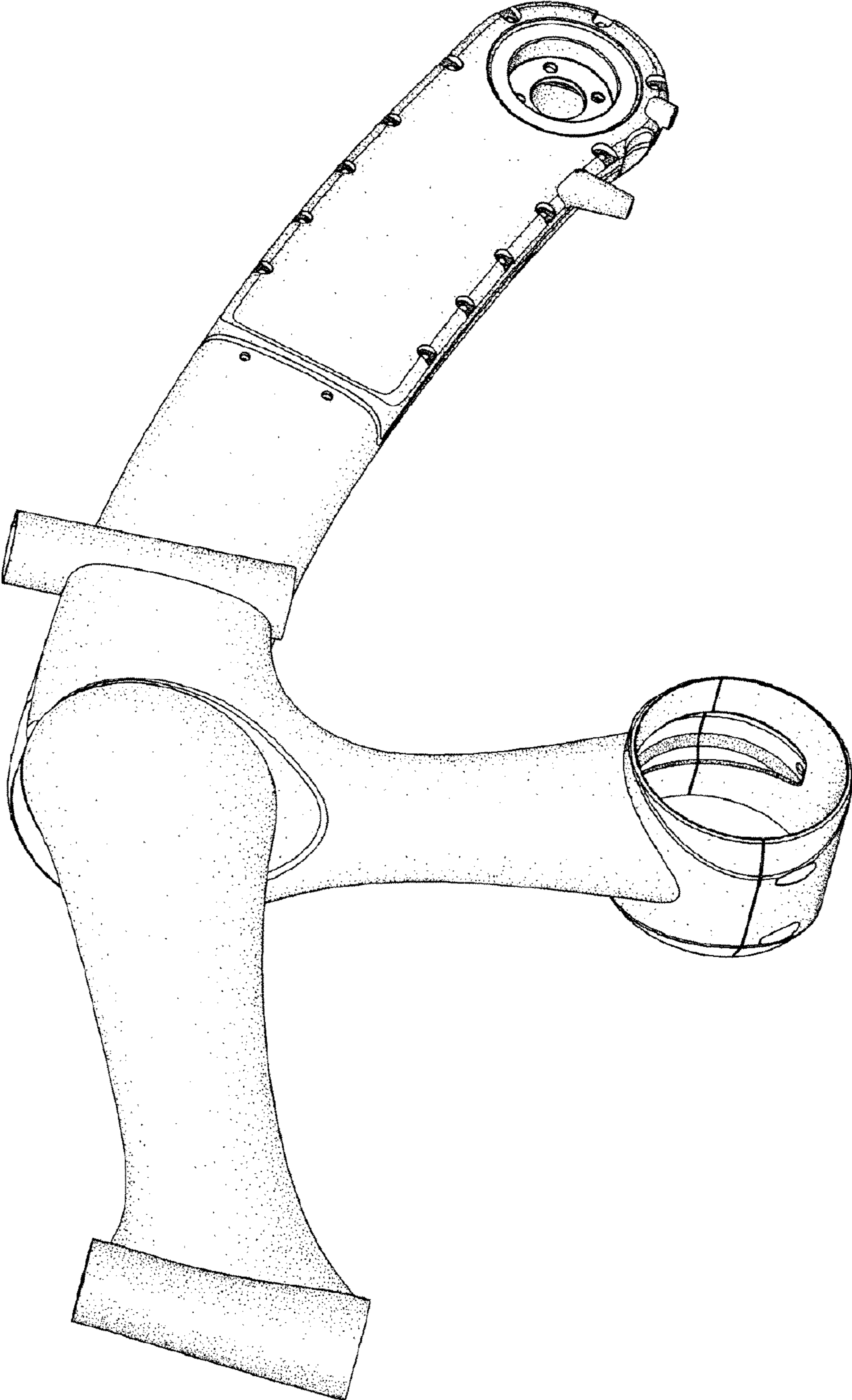

FIG. 2

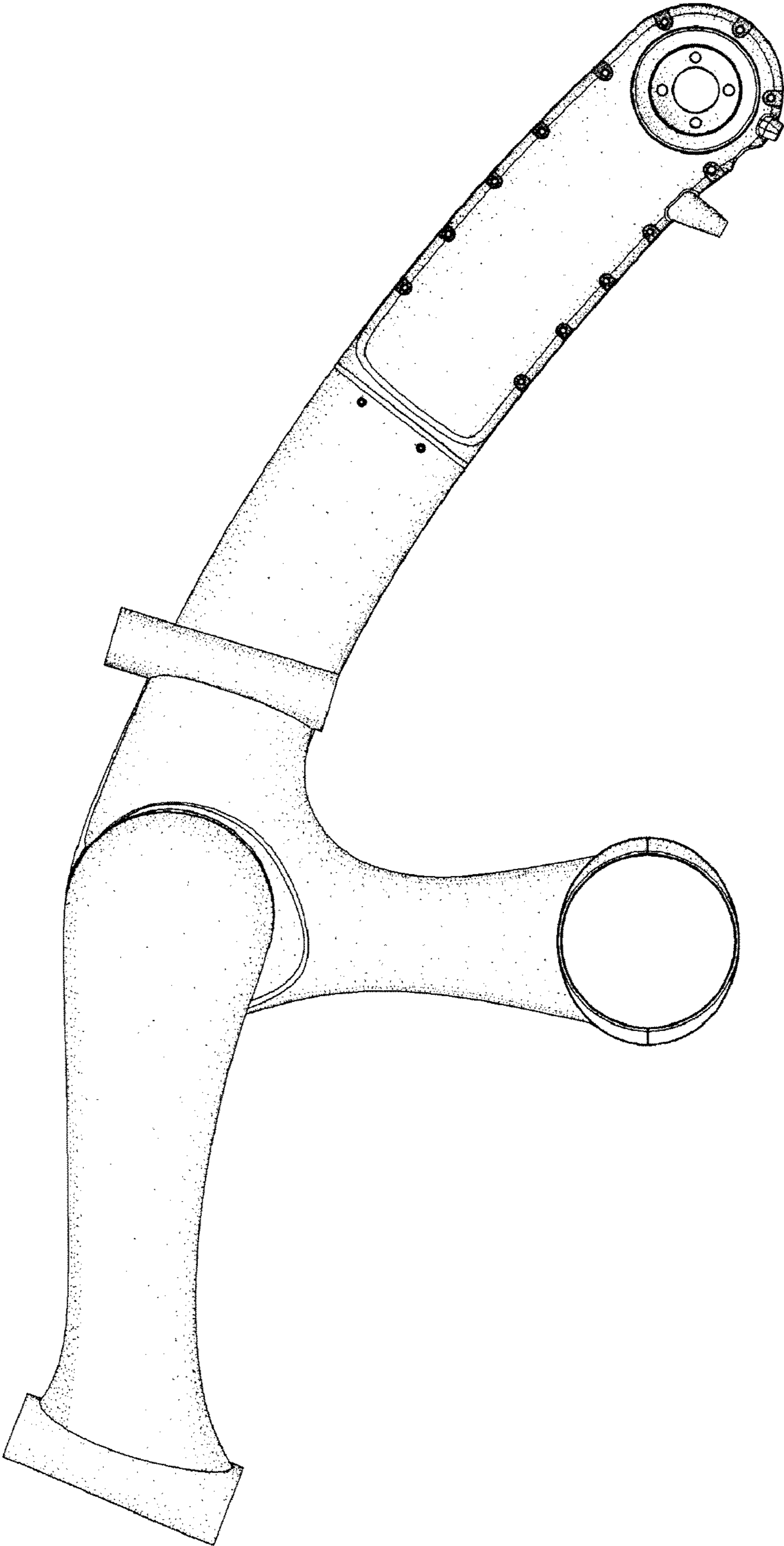

FIG. 3

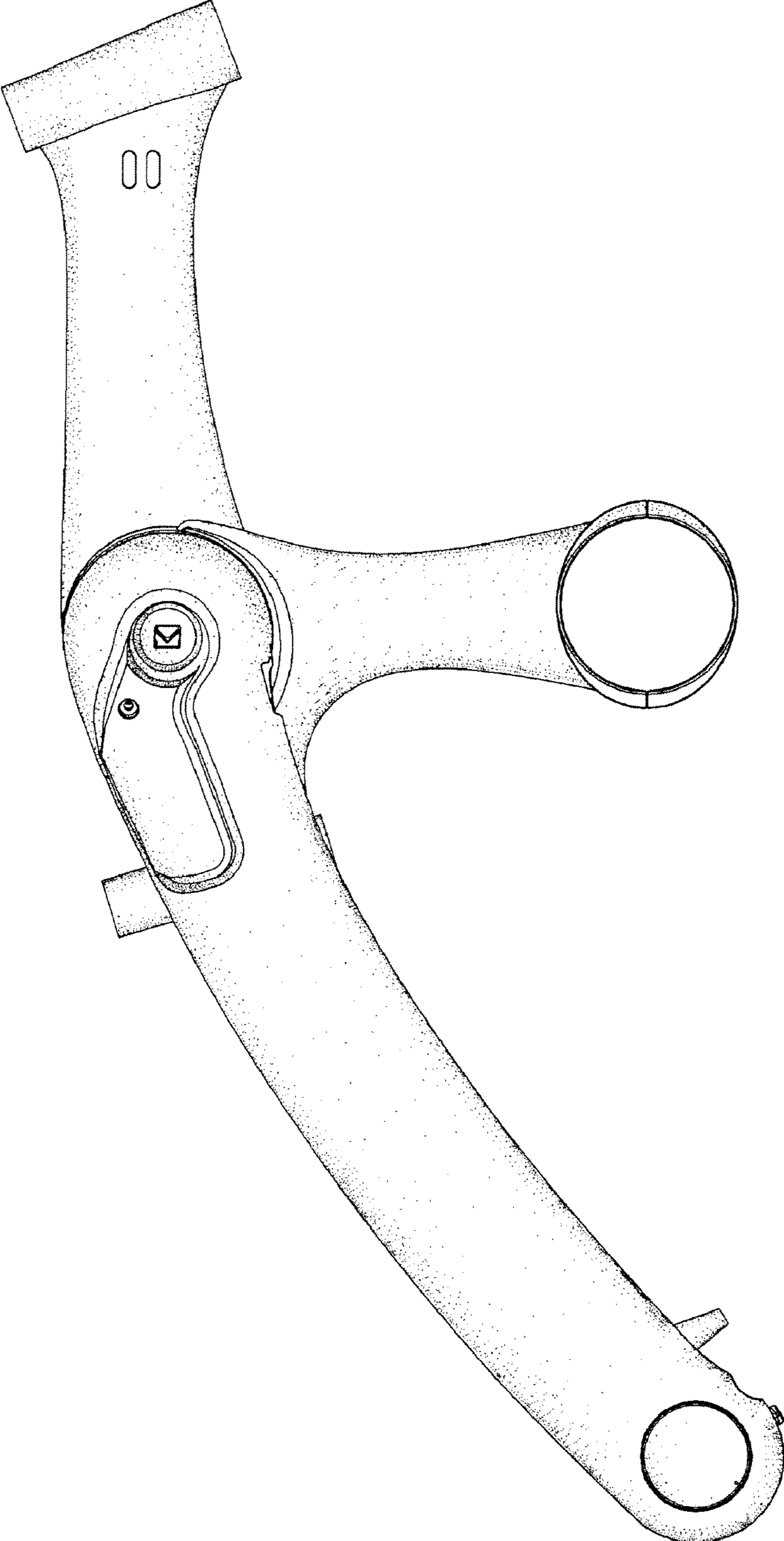

FIG. 4

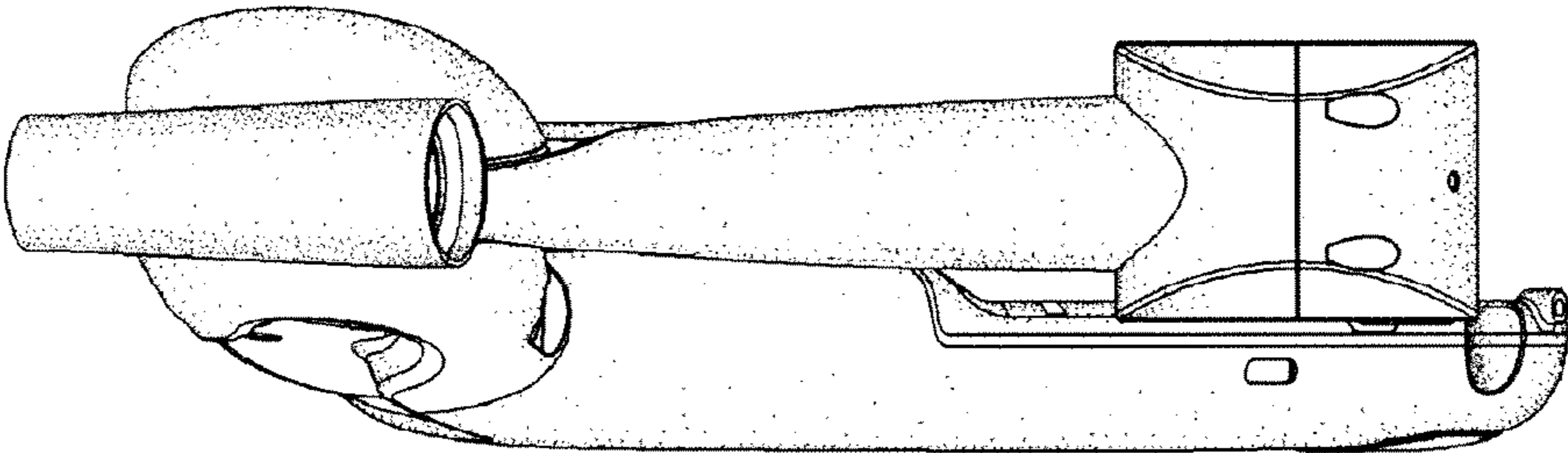

FIG. 5

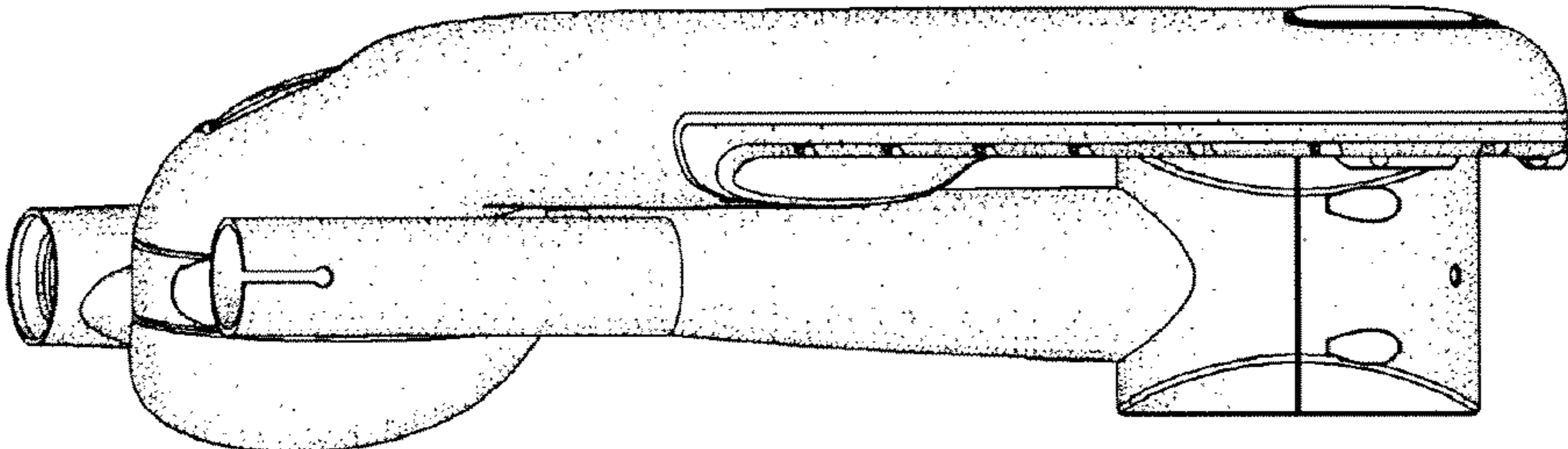

FIG. 6

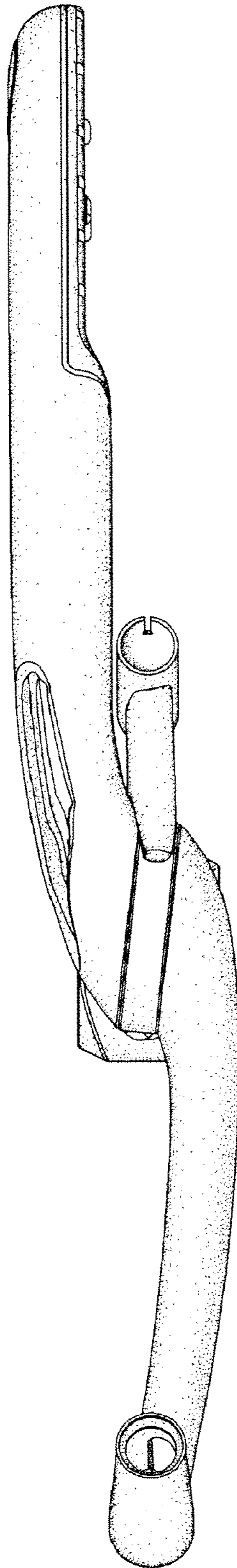

FIG. 7

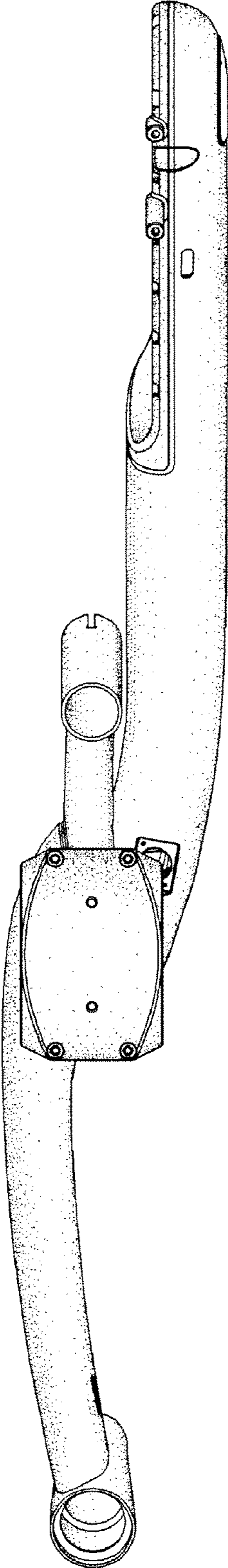

FIG. 8

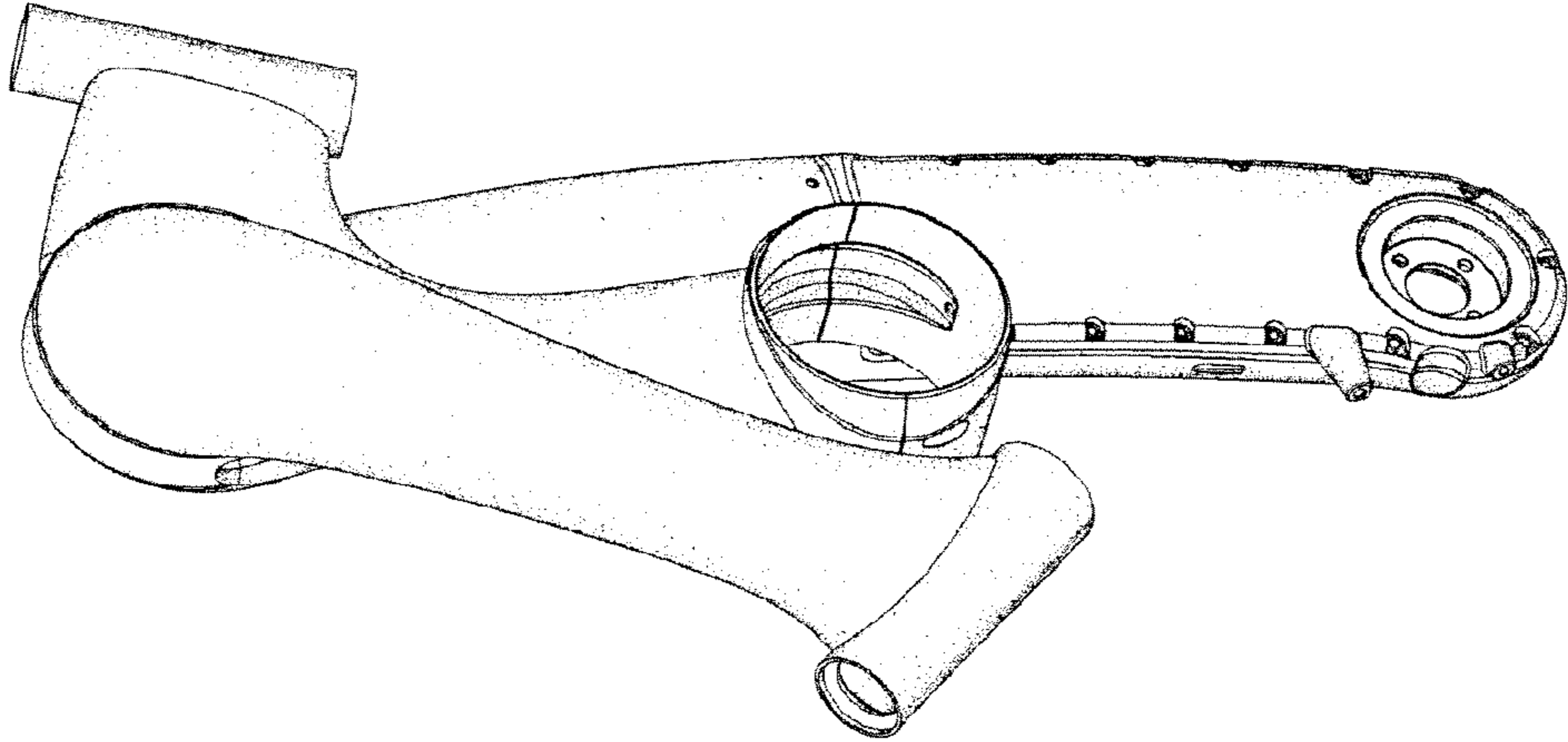

FIG. 9

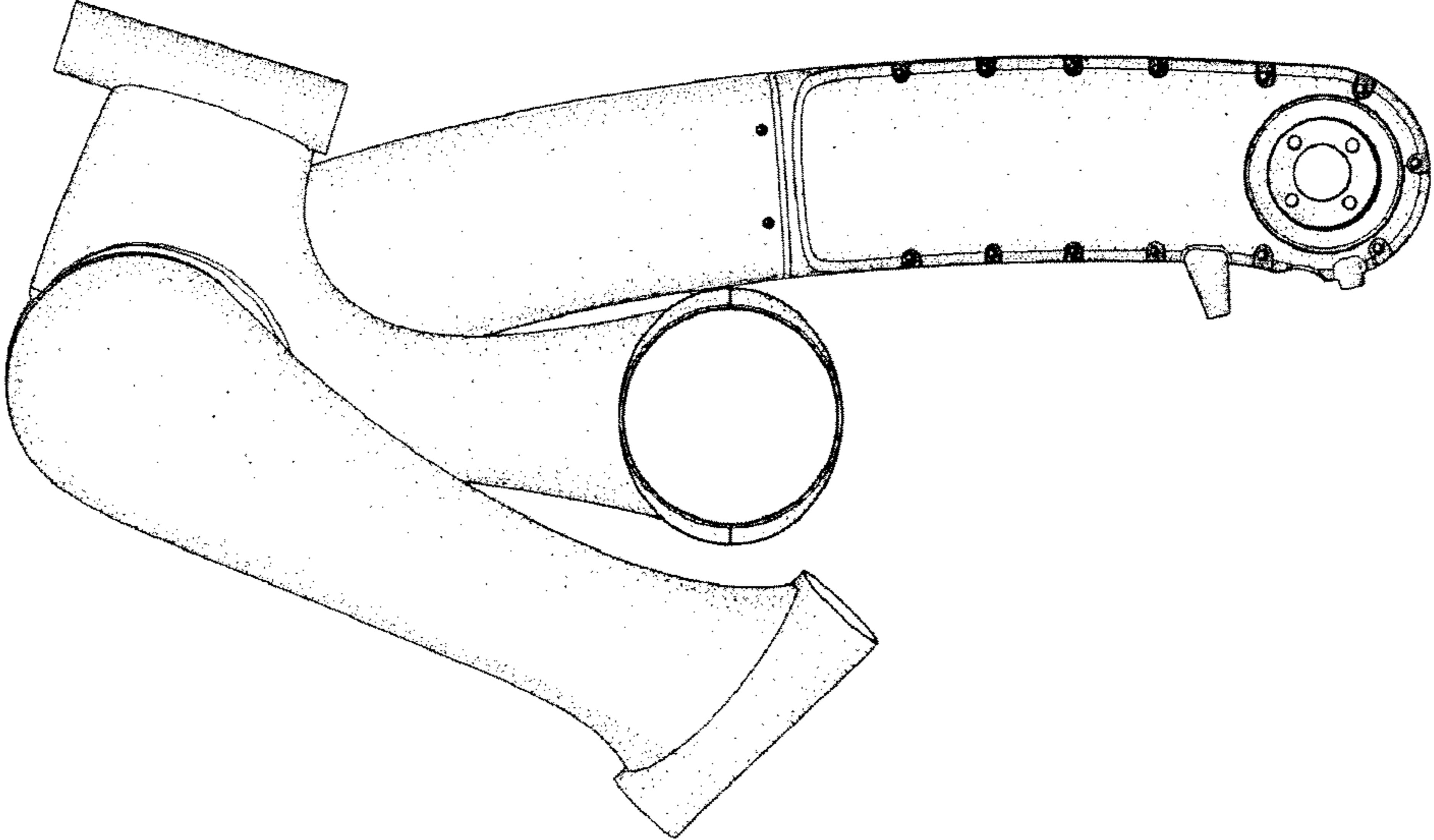

FIG. 10

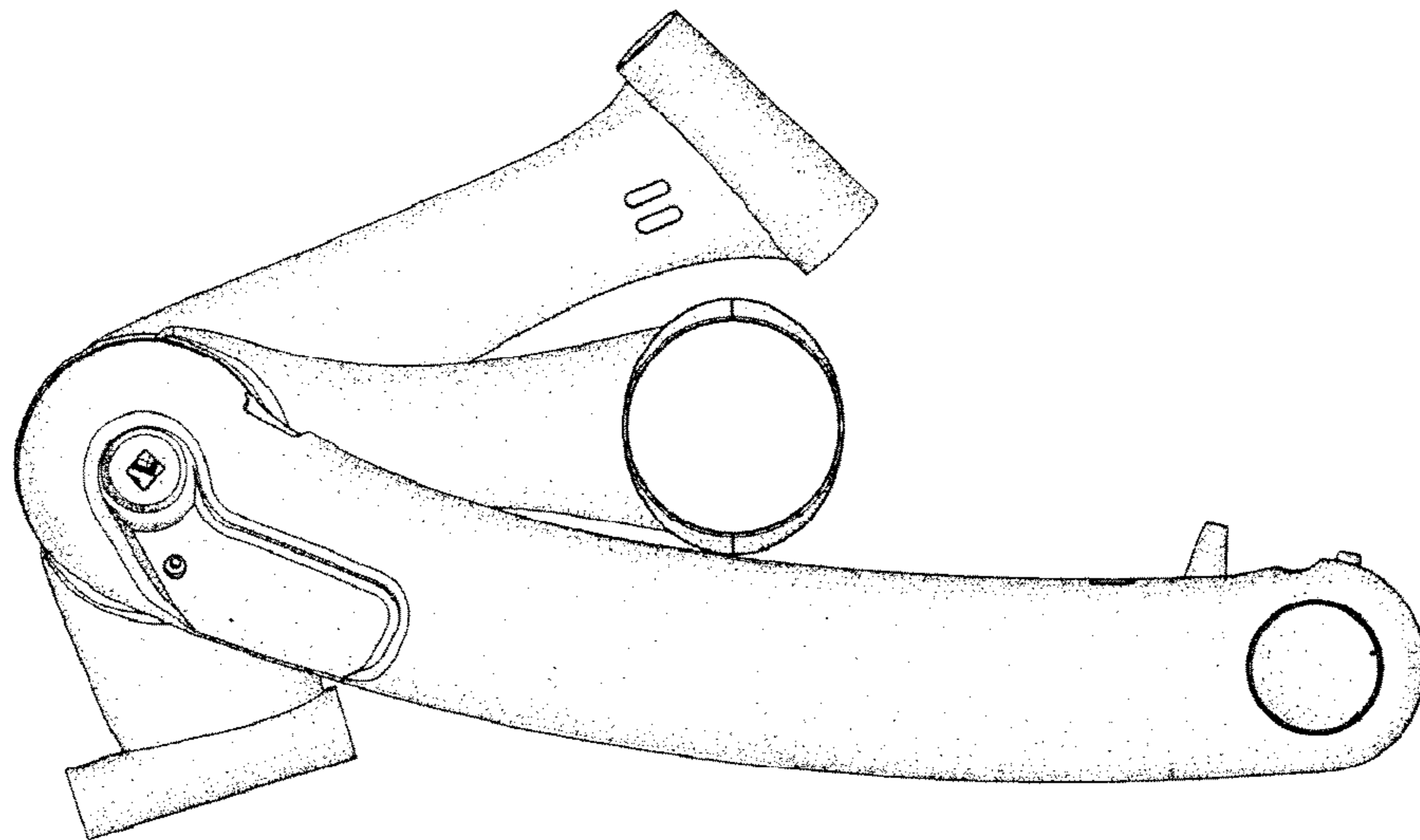

FIG. 11

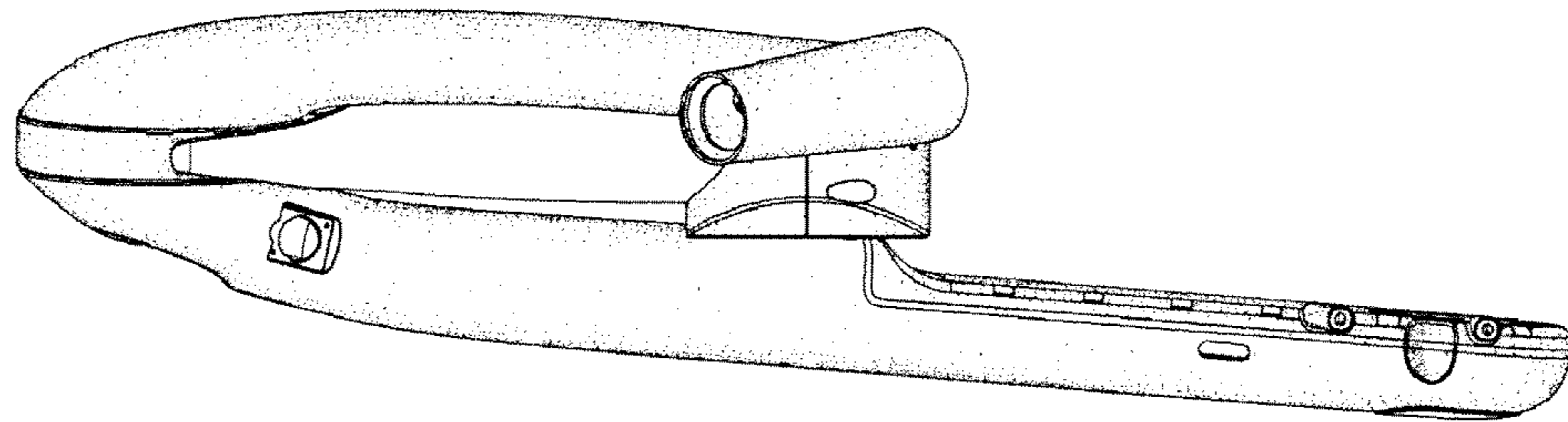

FIG. 12

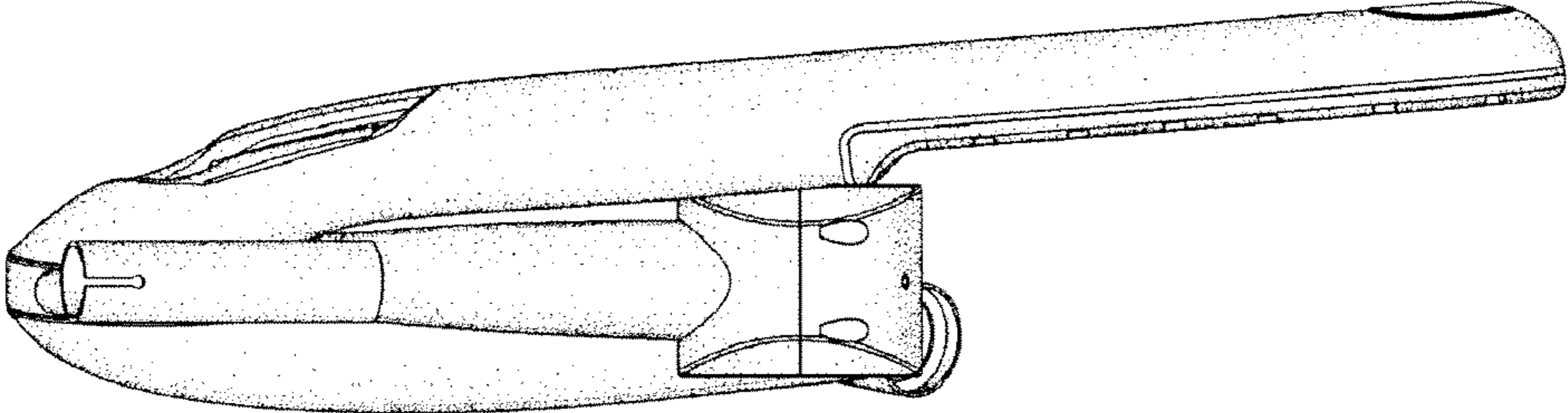

FIG. 13

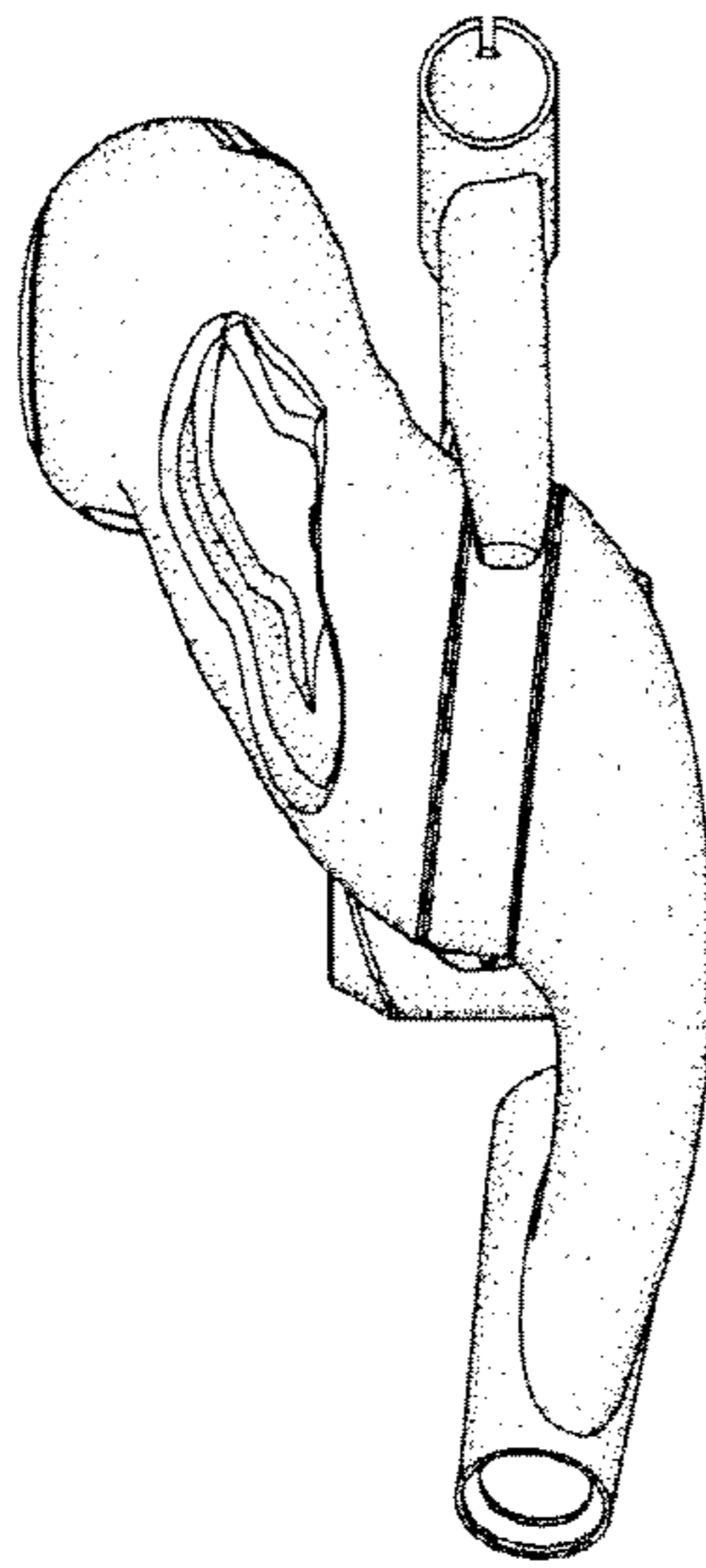

FIG. 14

