



US00D695635S

(12) **United States Design Patent**
Tokoi et al.

(10) **Patent No.:** **US D695,635 S**

(45) **Date of Patent:** **** Dec. 17, 2013**

(54) **CARRIER TAPE**

(75) Inventors: **Shogo Tokoi**, Otsu (JP); **Yasuhiro Shimizu**, Sabae (JP)

(73) Assignee: **Murata Manufacturing Co., Ltd.**, Kyoto-Fu (JP)

(**) Term: **14 Years**

(21) Appl. No.: **29/384,864**

(22) Filed: **Feb. 4, 2011**

(30) **Foreign Application Priority Data**

Aug. 6, 2010 (JP) 2010-019335
Aug. 6, 2010 (JP) 2010-019339

(51) **LOC (9) Cl.** **09-03**

(52) **U.S. Cl.**
USPC **D9/756; D9/730; D9/732**

(58) **Field of Classification Search**
USPC D9/756, 759; 220/23.83, 23.4; 206/713, 206/714, 460, 813, 725; 257/688
See application file for complete search history.

(56) **References Cited**

U.S. PATENT DOCUMENTS

4,898,275 A * 2/1990 Skrtic et al. 206/526
4,961,984 A * 10/1990 Takeda 428/192

(Continued)

FOREIGN PATENT DOCUMENTS

JP 2006-186078 A 7/2006
JP 2008-288609 A 11/2008

OTHER PUBLICATIONS

Fumiko Namiki; Notice of Grounds of Rejection; JPD2010-019335; Feb. 15, 2011.

(Continued)

Primary Examiner — Mark Goodwin

(74) *Attorney, Agent, or Firm* — Studebaker & Brackett PC

(57) **CLAIM**

The ornamental design for a carrier tape, as shown and described.

DESCRIPTION

FIG. 1 is a front view of a carrier tape of a first embodiment showing our new design, with a middle portion broken away to disclose indefinite length;

FIG. 2 is a top plan view thereof, with a middle portion broken away to disclose indefinite length;

FIG. 3 is a bottom plan view thereof, with a middle portion broken away to disclose indefinite length;

FIG. 4 is a left side view thereof;

FIG. 5 is an enlarged view taken along line 5-5 of FIG. 1 thereof;

FIG. 6 is an enlarged sectional view taken along line 6-6 of FIG. 2 thereof;

FIG. 7 is an enlarged sectional view taken along line 7-7 of FIG. 2 thereof;

FIG. 8 is a front view of a carrier tape of a second embodiment showing our new design, with a middle portion broken away to disclose indefinite length;

FIG. 9 is a top plan view thereof, with a middle portion broken away to disclose indefinite length;

FIG. 10 is a bottom plan view thereof, with a middle portion broken away to disclose indefinite length;

FIG. 11 is a left side view thereof;

FIG. 12 is an enlarged view taken along line 12-12 of FIG. 8 thereof;

FIG. 13 is an enlarged sectional view taken along line 13-13 of FIG. 9 thereof;

FIG. 14 is an enlarged sectional view taken along line 14-14 of FIG. 9 thereof; and,

FIG. 15 is a referential enlarged left side view showing the transparent portion.

The claimed design is shown with a middle portion of several views being broken away to disclose indefinite length.

The broken line showing of an electronic component in FIGS. 9, 11, 14, and 15 is included for the purpose of illustrating environmental structure only and forms no part of the claimed design.

1 Claim, 5 Drawing Sheets

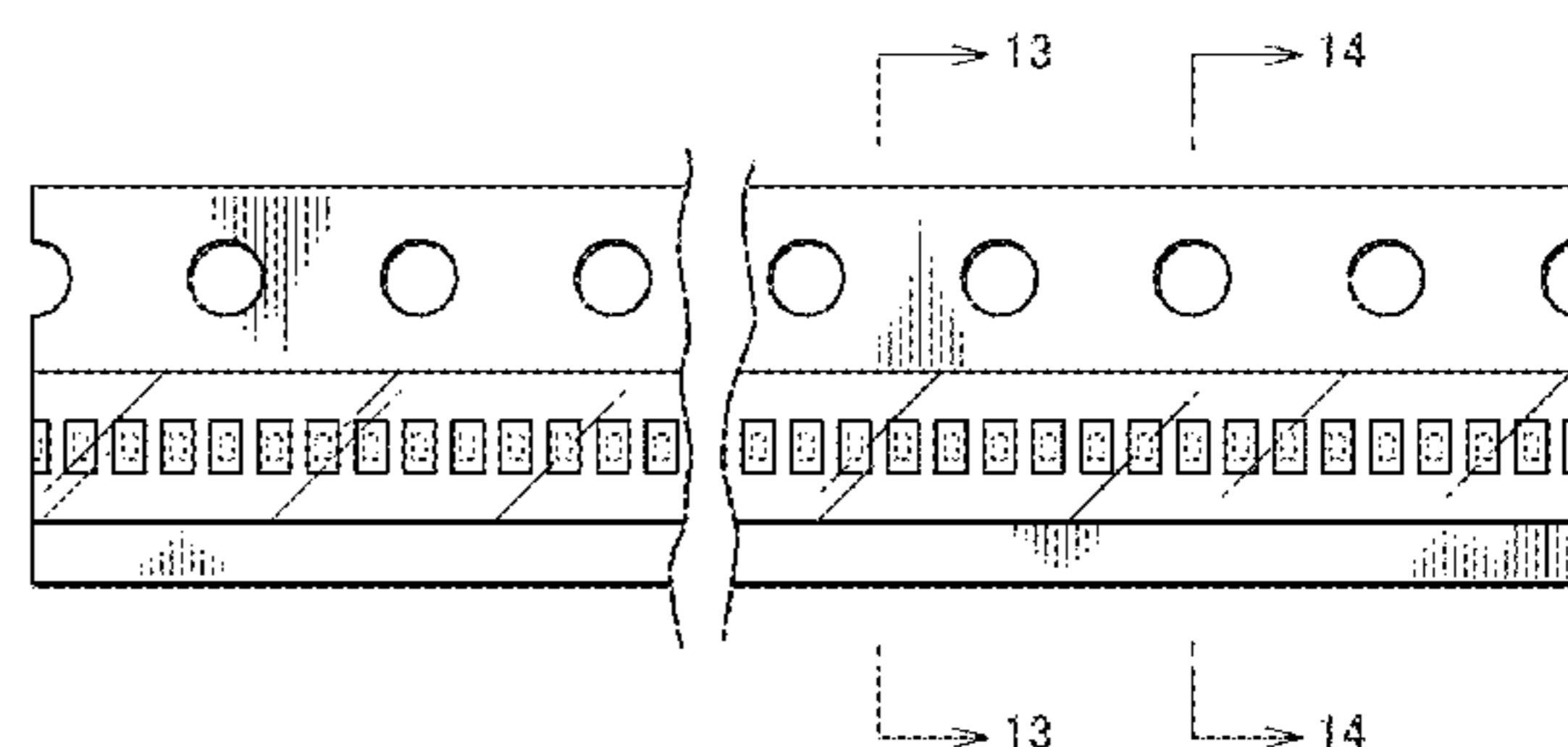
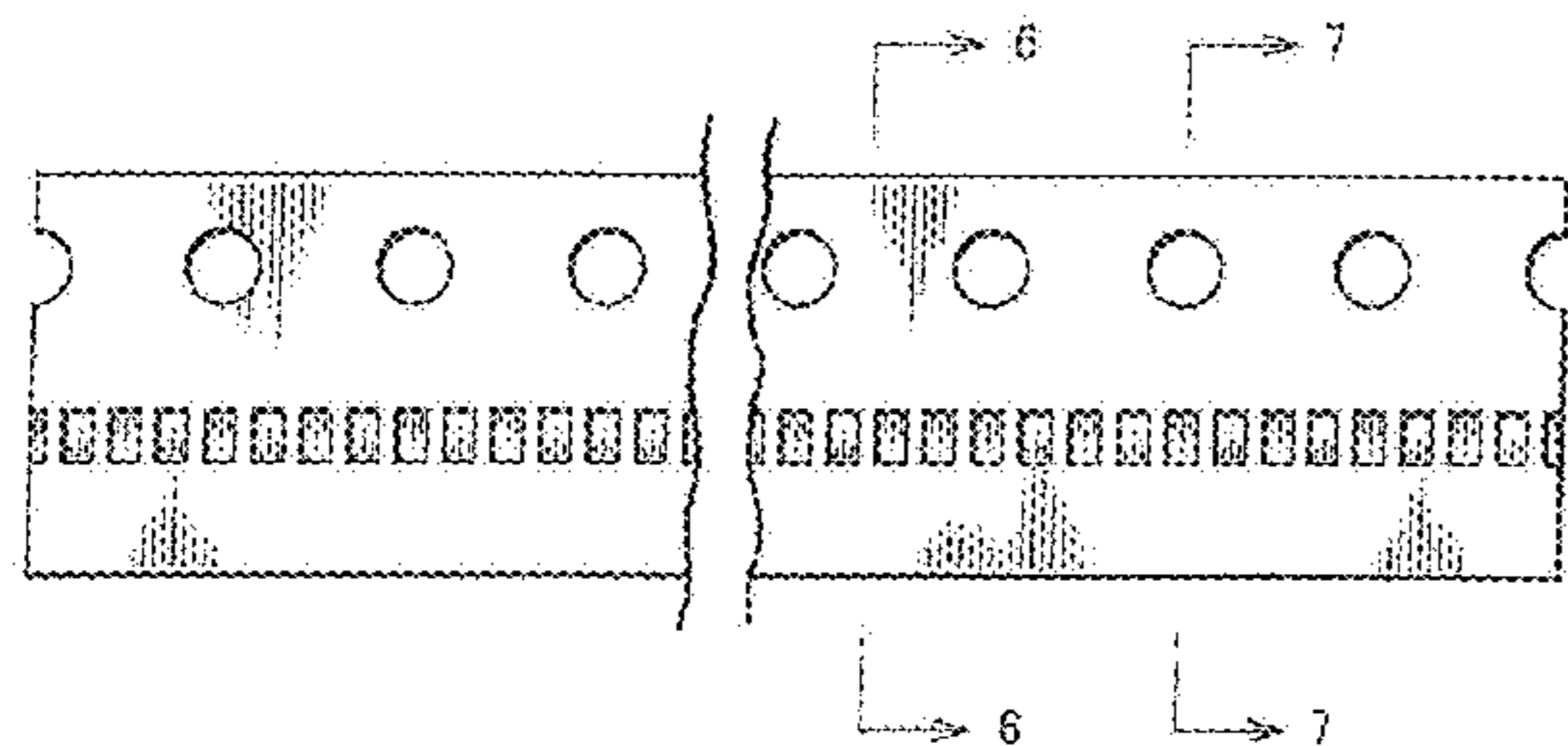

(56)

References Cited

U.S. PATENT DOCUMENTS

5,152,393 A * 10/1992 Chenoweth 206/714
 5,361,901 A * 11/1994 Schenz et al. 206/714
 5,769,237 A * 6/1998 Althouse et al. 206/714
 5,992,639 A * 11/1999 Naito et al. 206/714
 6,270,614 B1 * 8/2001 Naito et al. 156/272.2
 6,293,404 B1 * 9/2001 Bloom 206/714
 6,425,484 B1 * 7/2002 Sakurai 206/714
 6,467,627 B1 * 10/2002 Troxtell, Jr. 206/714
 6,536,593 B2 * 3/2003 Hatakeyama 206/714
 6,547,076 B1 * 4/2003 Pylant 206/713
 6,729,474 B2 * 5/2004 Hong et al. 206/714
 D510,278 S * 10/2005 Mikami et al. D9/756
 D510,279 S * 10/2005 Okouchi D9/756
 D516,924 S * 3/2006 Mikami D9/756

7,021,467 B2 * 4/2006 Agari 206/714
 7,654,392 B2 * 2/2010 Agari 206/714
 2006/0108259 A1 * 5/2006 Agari 206/714
 2006/0157381 A1 * 7/2006 Adams et al. 206/713
 2006/0157382 A1 * 7/2006 Yasufuku et al. 206/714
 2007/0074996 A1 * 4/2007 Nice et al. 206/714
 2007/0119746 A1 * 5/2007 Kuo 206/714
 2008/0023368 A1 * 1/2008 Soto 206/717
 2009/0173660 A1 * 7/2009 Lee et al. 206/713
 2012/0037538 A1 * 2/2012 Tokoi et al. 206/714
 2012/0118789 A1 * 5/2012 Hiramatsu 206/714

OTHER PUBLICATIONS

Fumiko Namiki; Notice of Grounds of Rejection; JPD2010-019339;
 Feb. 15, 2011.

* cited by examiner

FIG. 1



FIG. 2

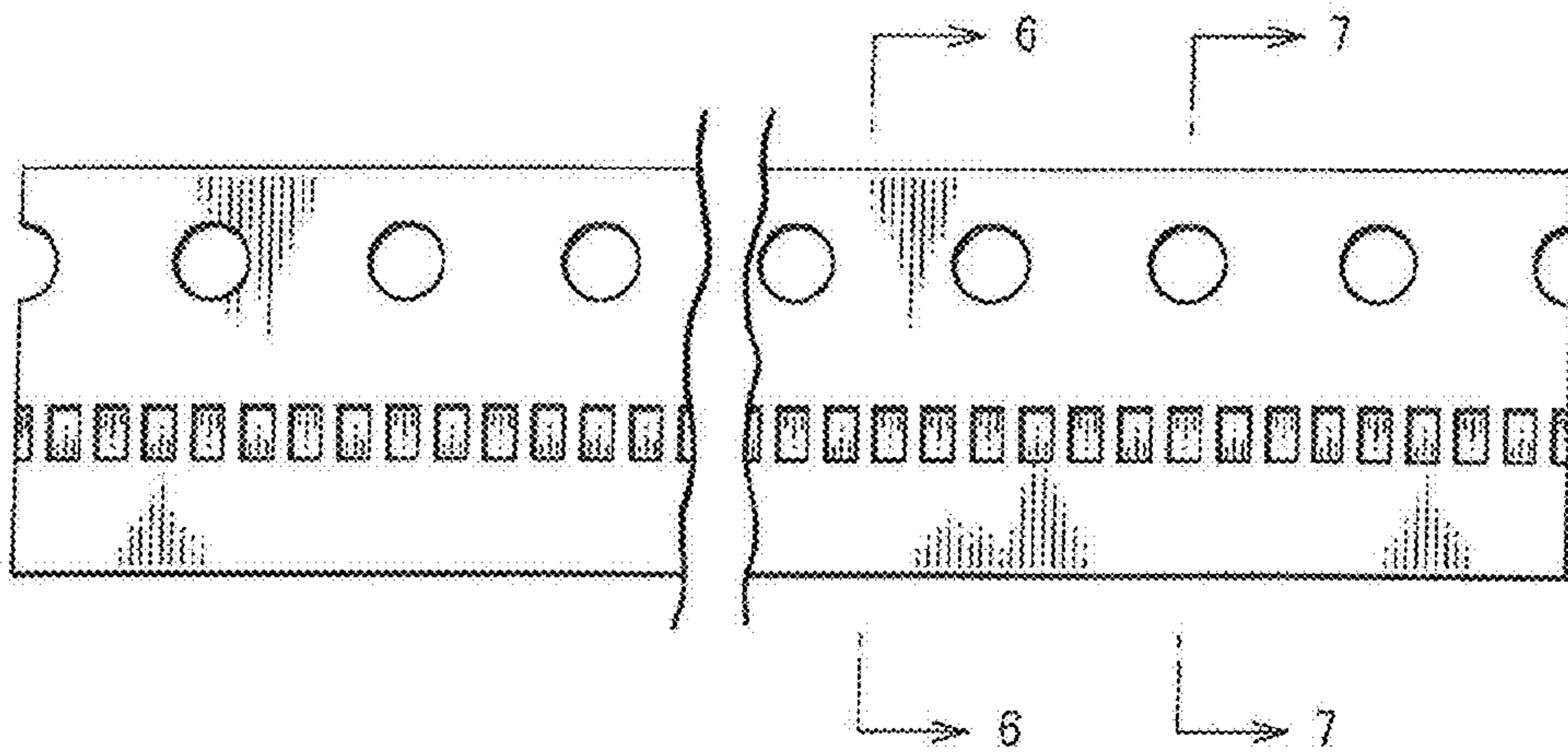

FIG. 3

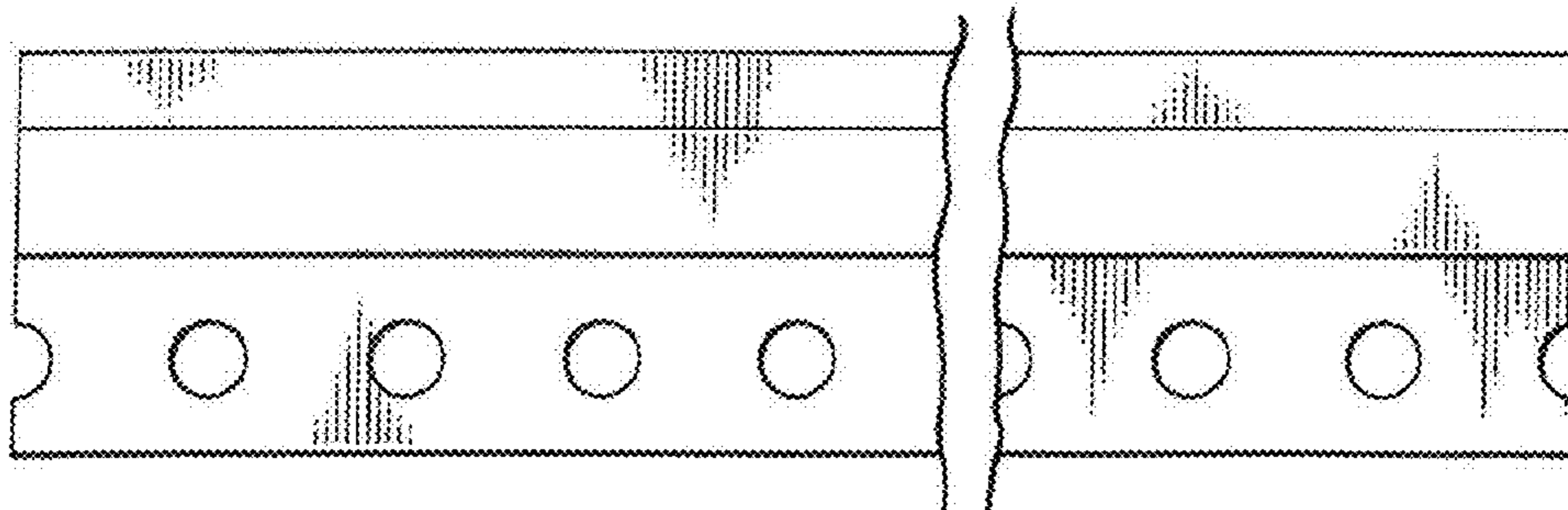

FIG. 4

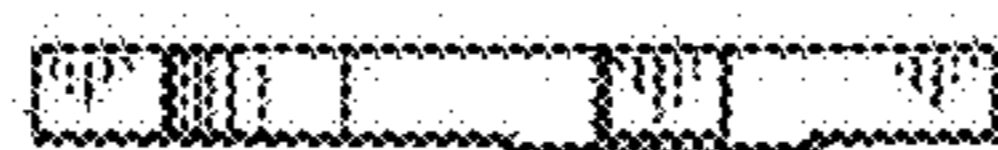

FIG.5



FIG.6



FIG.7



FIG.8

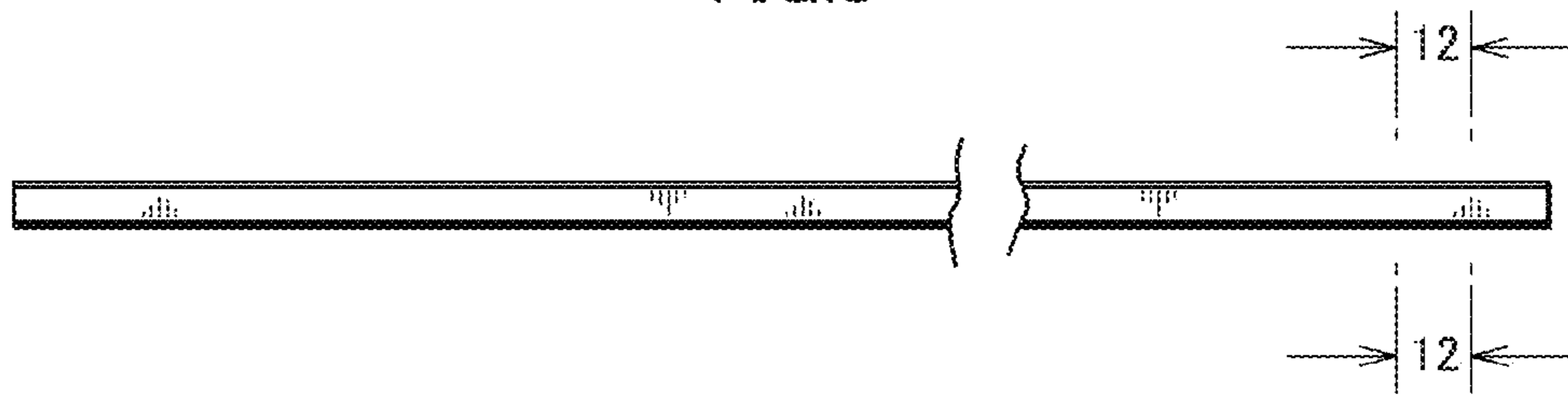

FIG.9

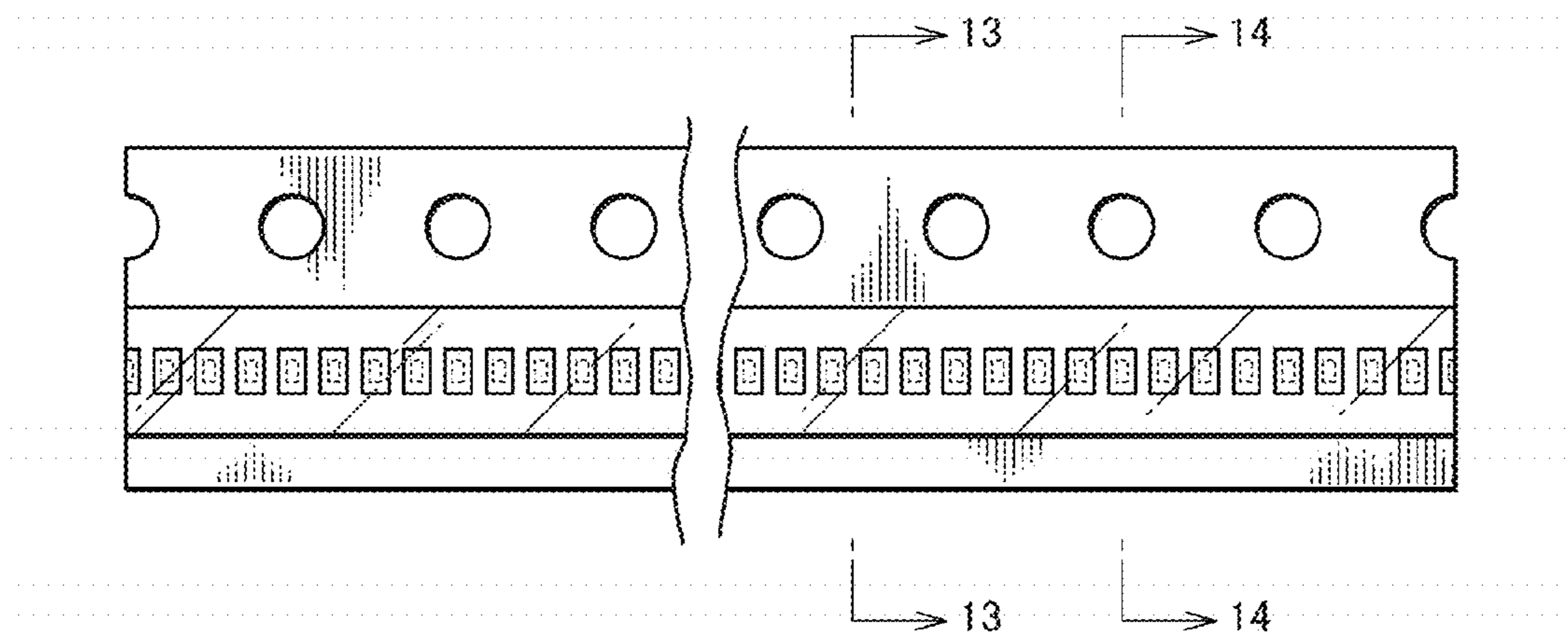

FIG.10

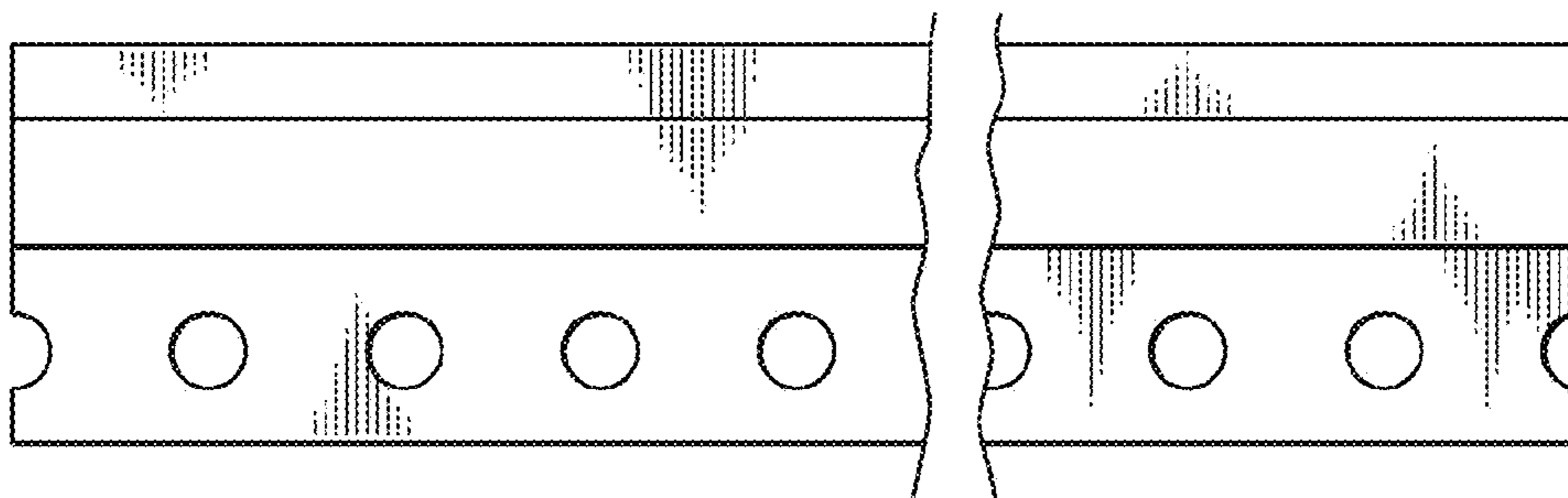

FIG.11

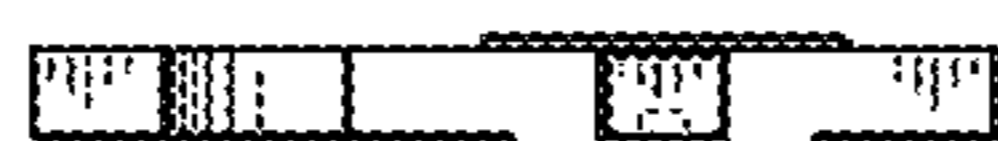

FIG. 12



FIG. 13

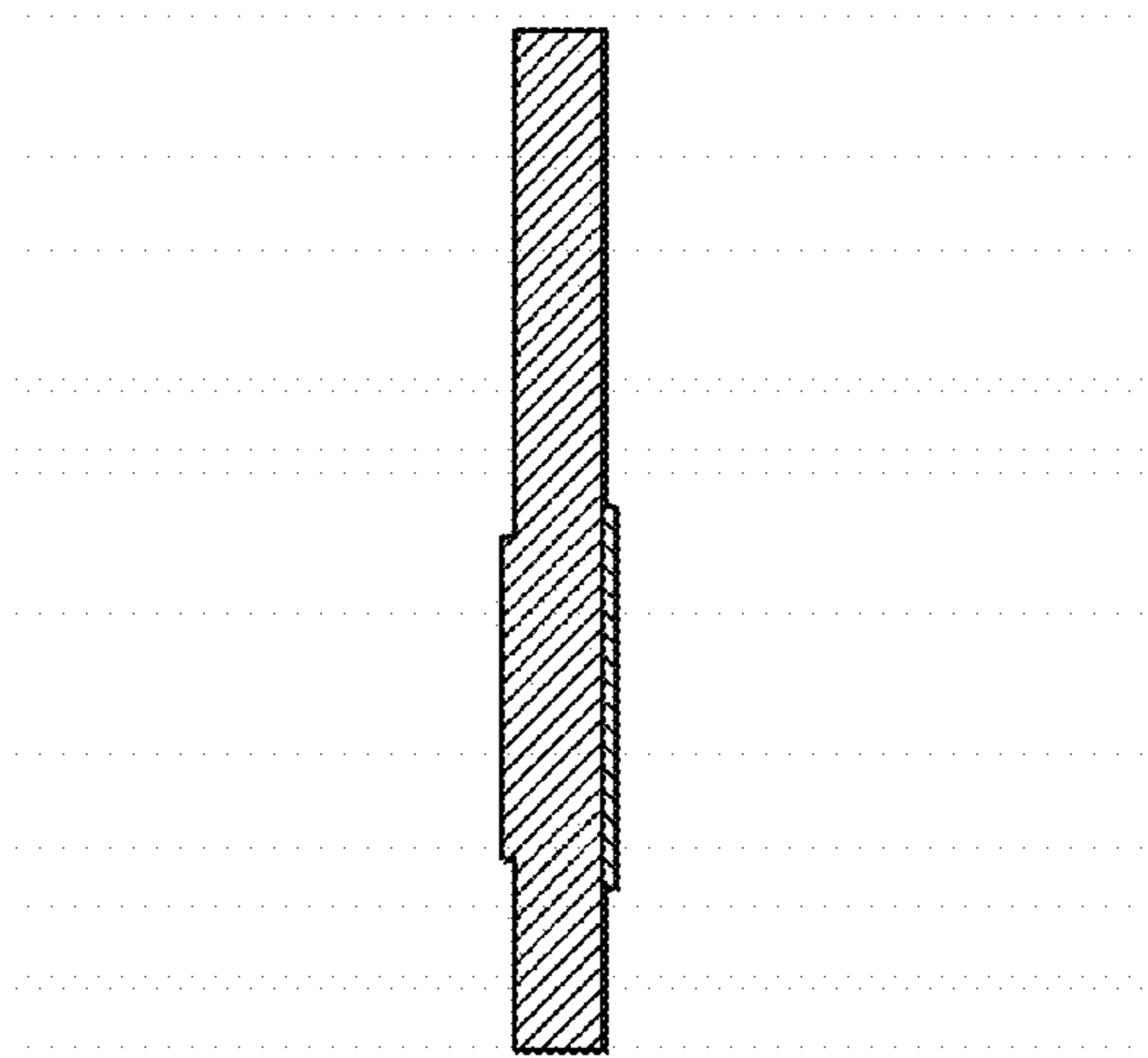

FIG. 14

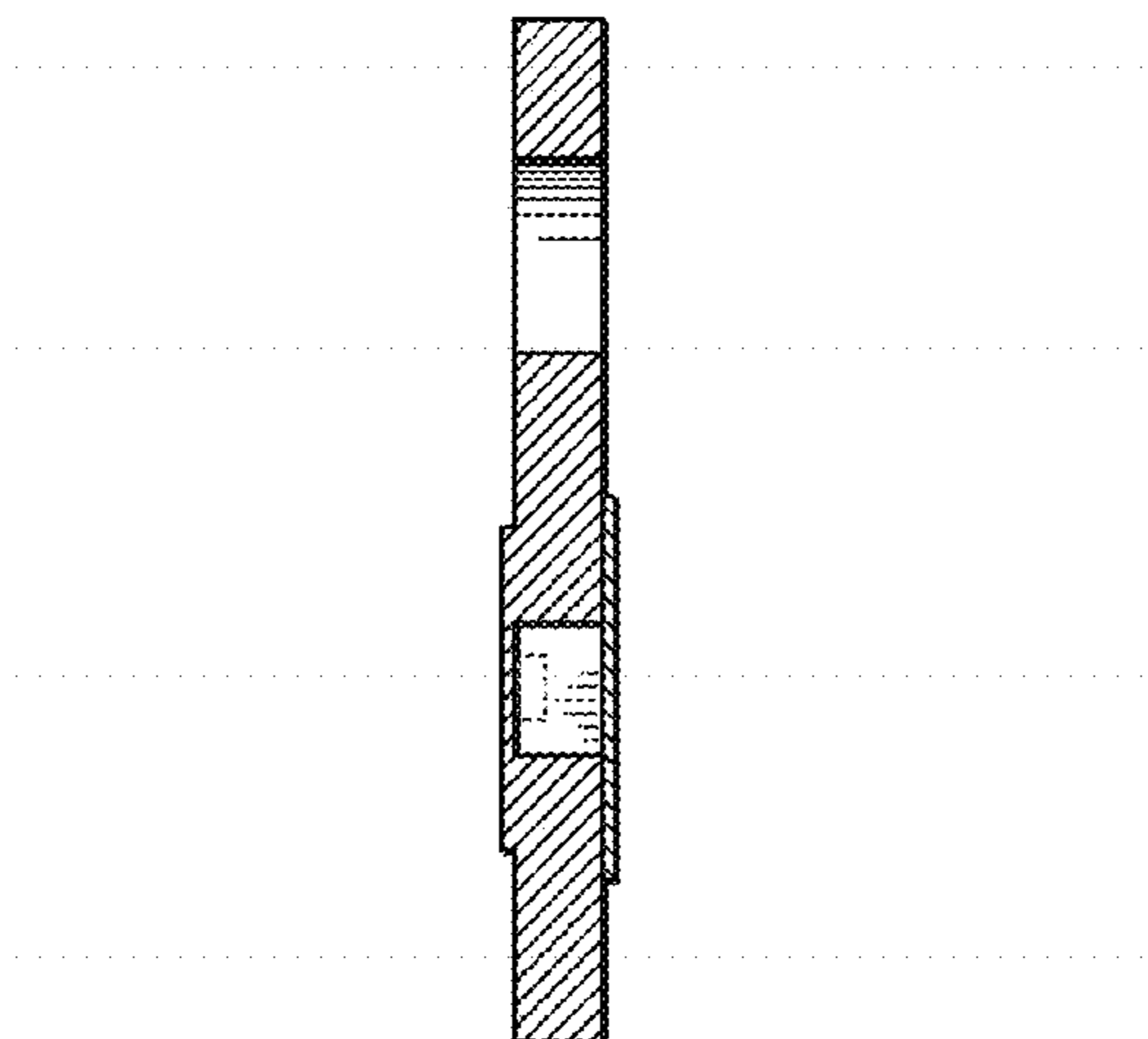

FIG. 15

