



US00D695621S

(12) **United States Design Patent**
Marotti et al.

(10) **Patent No.:** **US D695,621 S**

(45) **Date of Patent:** **** Dec. 17, 2013**

(54) **BOTTLE**

(75) Inventors: **Martin Jay Marotti**, Carmel, IN (US);
Juan Carlos Vinseiro, Mason, OH (US)

(73) Assignee: **The Procter & Gamble Company**,
Cincinnati, OH (US)

(**) Term: **14 Years**

(21) Appl. No.: **29/401,146**

(22) Filed: **Sep. 8, 2011**

(51) **LOC (9) Cl.** **09-01**

(52) **U.S. Cl.**
USPC **D9/542; D9/544; D9/571; D9/574**

(58) **Field of Classification Search**
USPC **D9/516, 530, 541-546, 549, 558,**
D9/571-575, 682, 686-692, 694, 550,
D9/563; D7/300, 598; 215/379, 381-382;
220/660, 662, 669, 675; D20/10-11,
D20/22

See application file for complete search history.

(56) **References Cited**

U.S. PATENT DOCUMENTS

D24,181 S	4/1895	May
D47,434 S	6/1915	Orem
D50,594 S	4/1916	Voges
D49,406 S	7/1916	Vivaudou
D73,128 S	7/1927	Harris
D87,397 S	7/1932	Marshburn et al.
D117,266 S	6/1939	Gerhart
D164,743 S	10/1951	Terry
D166,641 S	4/1952	Terry
D175,447 S	8/1955	Tucker
D176,225 S	11/1955	Morris
D187,820 S	5/1960	Oradell
D194,090 S	11/1962	Mercorelli
D202,219 S	9/1965	Drummond, Jr.
D207,350 S	4/1967	Koenigsberg
D211,005 S	5/1968	Vanderhyde

D211,319 S	6/1968	Jeronimus	
D215,699 S	10/1969	Horne et al.	
D216,540 S *	2/1970	Douglas	D9/563
D217,591 S	5/1970	Biscoe	
D222,337 S *	10/1971	Weckman	D9/574

(Continued)

FOREIGN PATENT DOCUMENTS

WO	DM/070627	*	8/2008
WO	DM/070628	*	8/2008

(Continued)

Primary Examiner — Ian Simmons

Assistant Examiner — Dana L Meyrow

(74) *Attorney, Agent, or Firm* — James E. Oehlenschlager

(57) **CLAIM**

We claim the ornamental design for a bottle, as shown and described.

DESCRIPTION

FIG. 1 is a front perspective view showing our new design for a bottle;

FIG. 2 is a front elevational view thereof;

FIGS. 3 and 4 are side elevational views thereof;

FIG. 5 is a rear elevational view thereof;

FIG. 6 is a top plan view thereof; and

FIG. 7 is a bottom view thereof;

FIG. 8 is a front perspective view showing an alternate embodiment of our new design for a bottle, the stippling being indicative of an opaque surface;

FIG. 9 is a front elevational view thereof;

FIGS. 10 and 11 are side elevational views thereof;

FIG. 12 is a rear elevational view thereof;

FIG. 13 is a top plan view thereof; and,

FIG. 14 is a bottom view thereof.

The broken lines shown in the drawings depict environmental subject matter only and form no part of the claimed design.

1 Claim, 10 Drawing Sheets

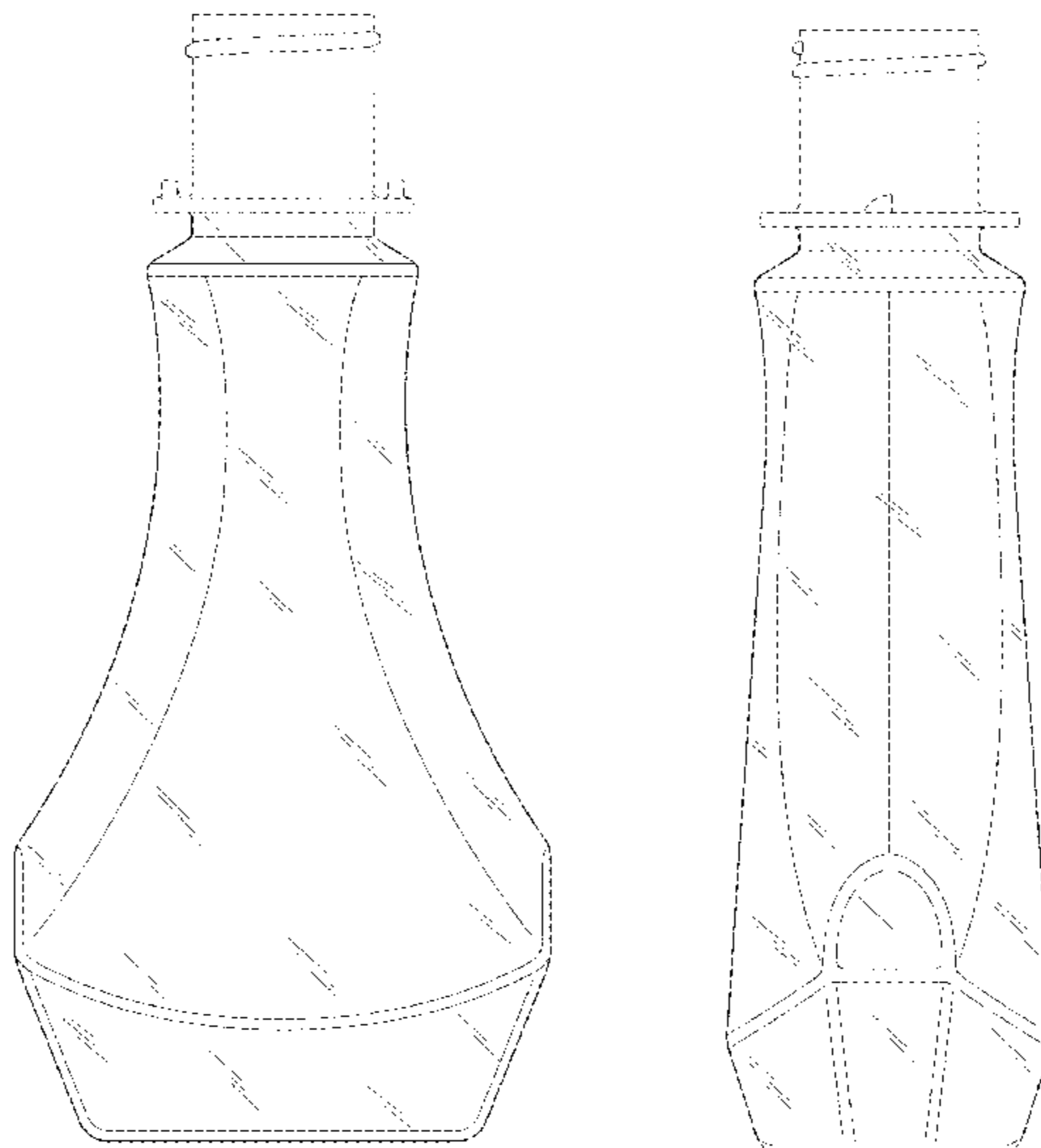

(56)

References Cited

U.S. PATENT DOCUMENTS

D222,610 S 11/1971 Plummer
 D222,712 S 12/1971 Barker
 D226,551 S * 3/1973 Weckman D9/542
 D228,343 S 9/1973 Kretz
 D232,079 S * 7/1974 Luedtke D9/529
 D232,146 S 7/1974 Dean
 D234,394 S 2/1975 Metzger
 D236,800 S * 9/1975 Pardo D9/542
 D241,318 S 9/1976 Lewman
 D243,442 S 2/1977 Montgomery
 D243,827 S * 3/1977 Ruriani D9/558
 D252,444 S 7/1979 Torongo, Jr.
 D253,166 S 10/1979 Pardo
 D264,305 S 5/1982 Pardo
 D278,124 S 3/1985 Coussie
 D282,529 S 2/1986 Pereira
 D339,487 S 9/1993 Rizzi
 D348,395 S * 7/1994 Bertolini D9/529
 D399,752 S 10/1998 Farmer
 D407,982 S * 4/1999 Bertolini D9/548
 6,670,009 B1 12/2003 Voss
 D488,647 S 4/2004 Ford et al.
 D516,627 S 3/2006 Collins et al.
 D522,876 S * 6/2006 Braaten et al. D9/691
 D527,824 S 9/2006 Mueller et al.
 D528,004 S 9/2006 Ratzlaff

D530,620 S 10/2006 Owens et al.
 D531,044 S 10/2006 Owens et al.
 D531,045 S 10/2006 Owens et al.
 D531,515 S 11/2006 Owens et al.
 D533,072 S 12/2006 Kelly
 D543,384 S 5/2007 Resterhouse et al.
 D559,107 S 1/2008 Bates et al.
 D561,838 S 2/2008 Beam et al.
 D565,954 S 4/2008 Adamson et al.
 D568,744 S 5/2008 Weber et al.
 D580,593 S 11/2008 Huntington
 D591,598 S 5/2009 Caroen et al.
 D591,607 S 5/2009 Marotti et al.
 D591,608 S * 5/2009 Marotti et al. D9/571
 D609,751 S * 2/2010 Marotti D20/22
 D623,521 S 9/2010 Marotti et al.
 D627,651 S 11/2010 Marotti
 D629,308 S 12/2010 Marotti
 D650,678 S * 12/2011 Marotti D9/516
 D656,828 S * 4/2012 Marotti D9/516
 2007/0020423 A1 1/2007 Chamandy et al.

FOREIGN PATENT DOCUMENTS

WO DM/072672 * 7/2009
 WO DM/076094 * 5/2011
 WO DM/076095 * 5/2011

* cited by examiner

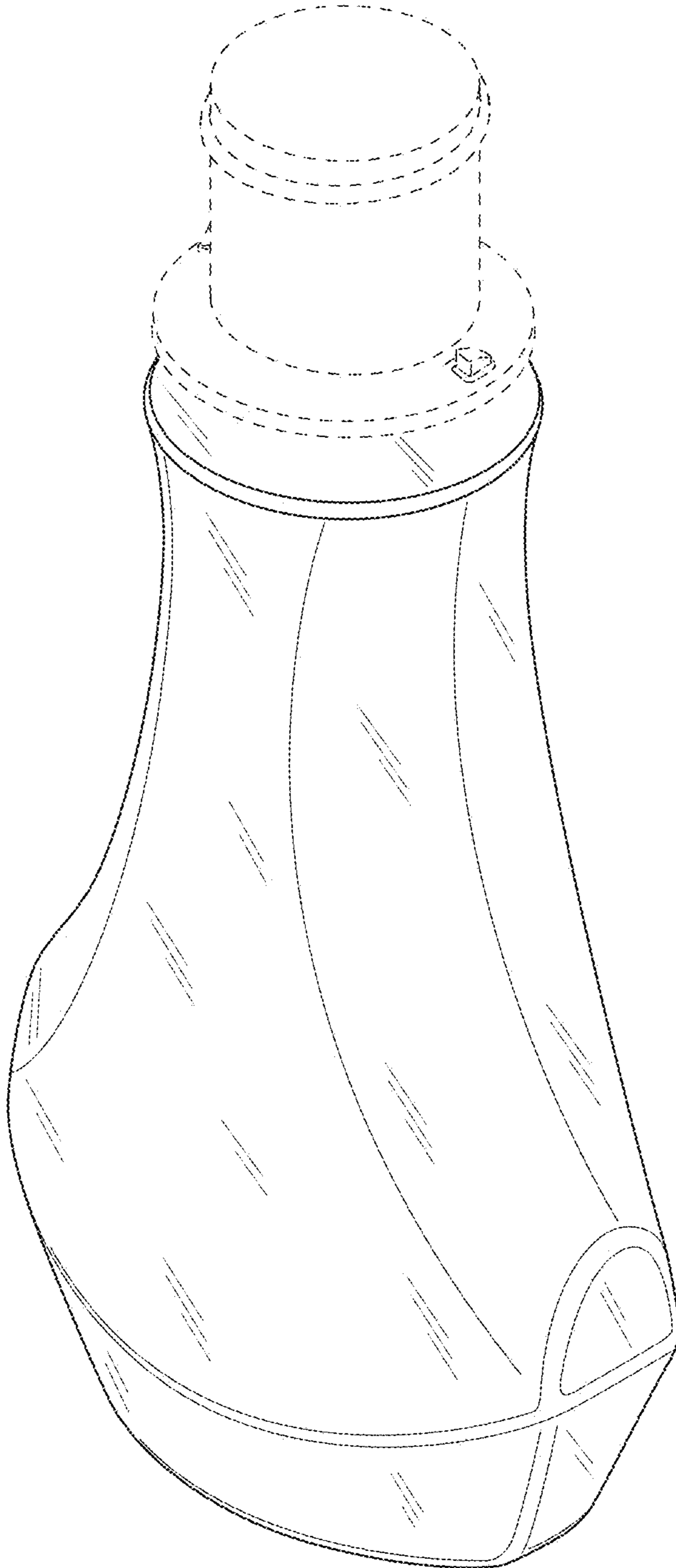

Fig. 1

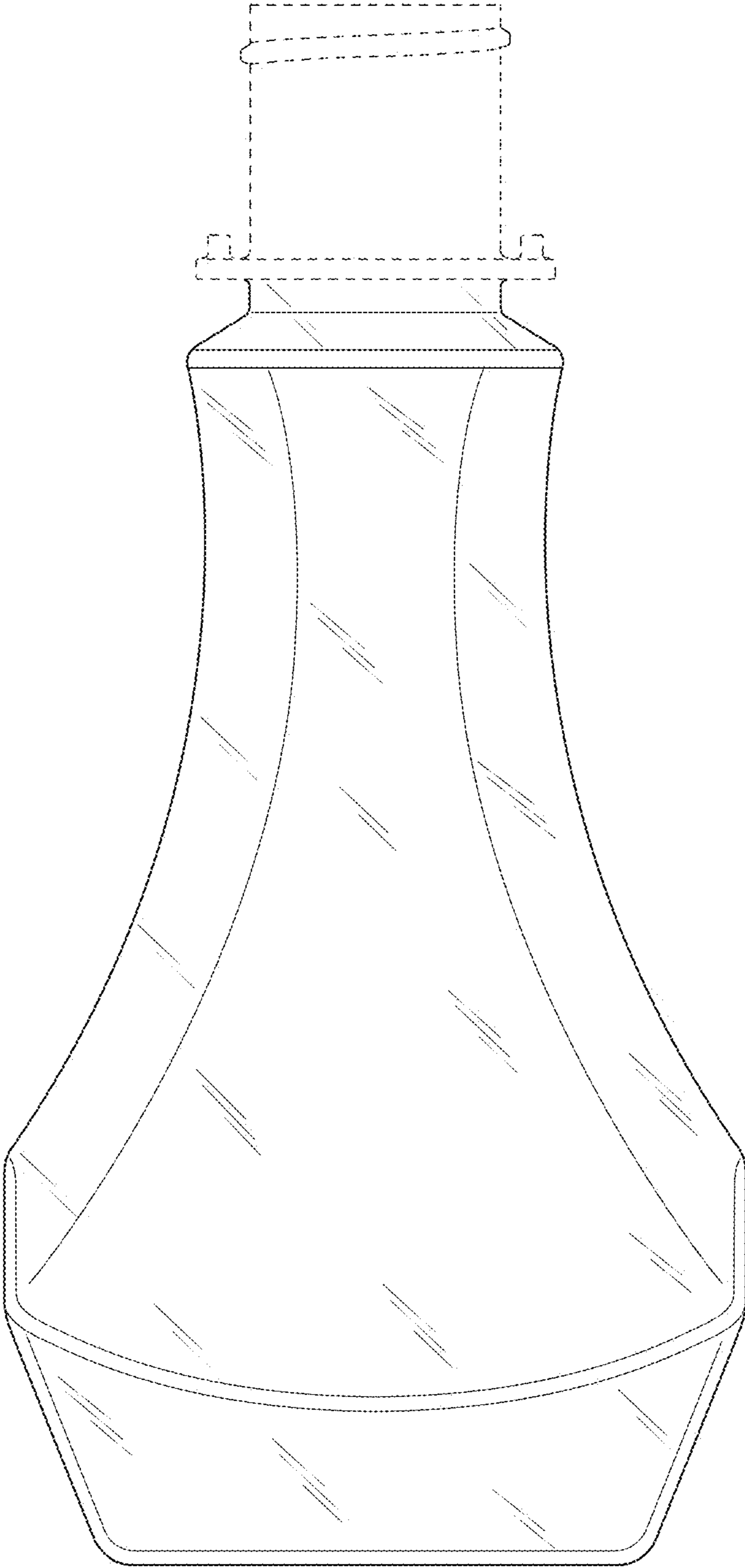

Fig. 2

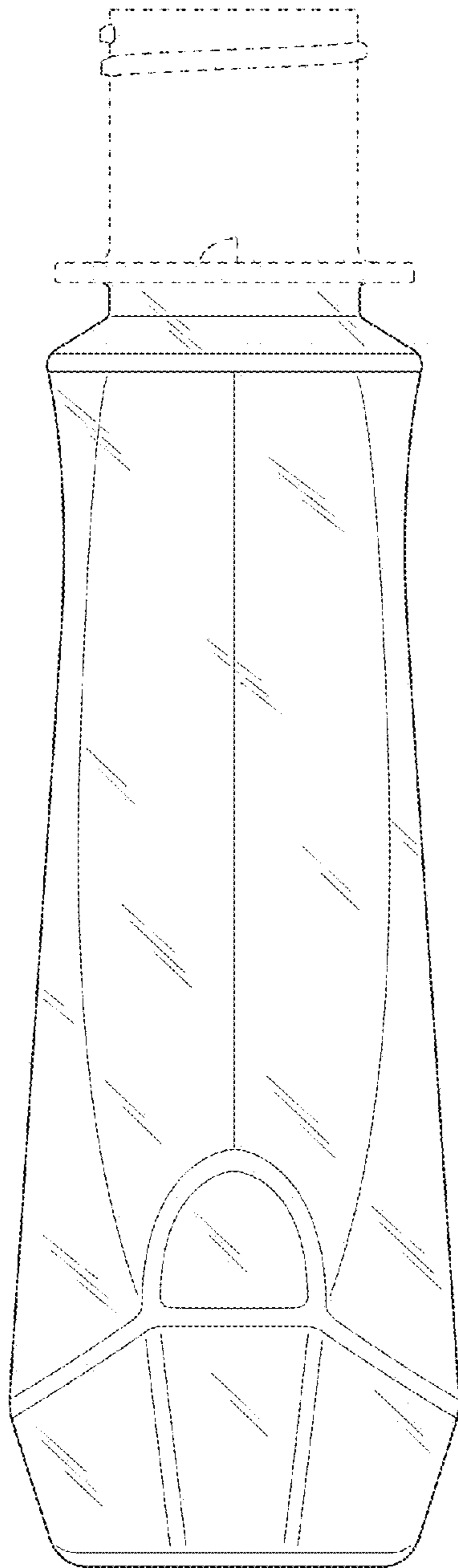

Fig. 3

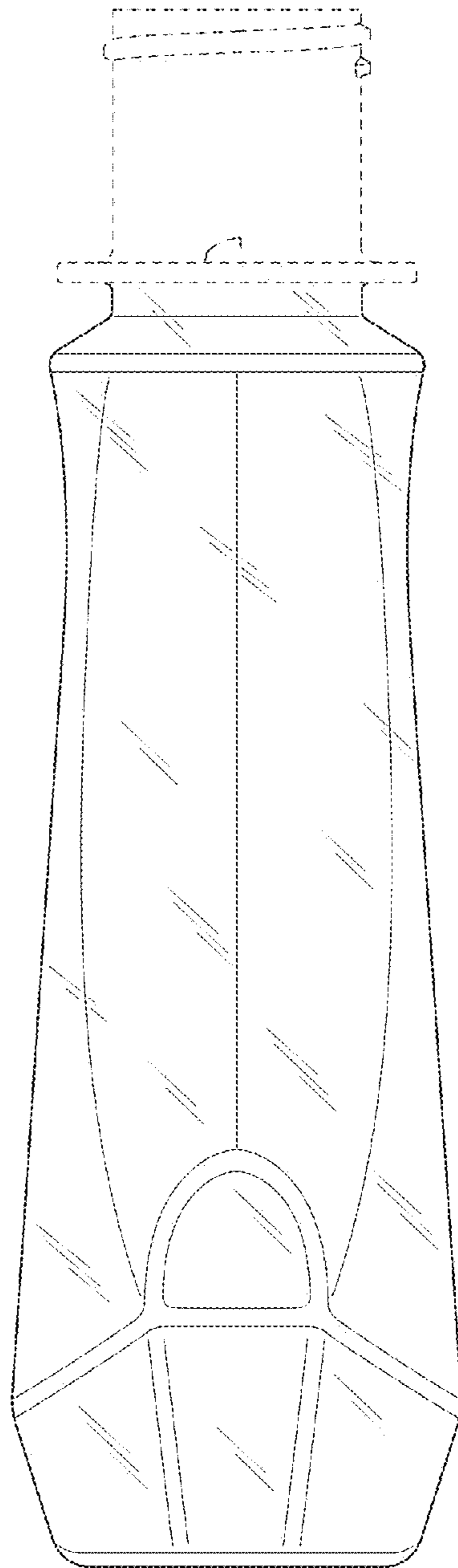

Fig. 4

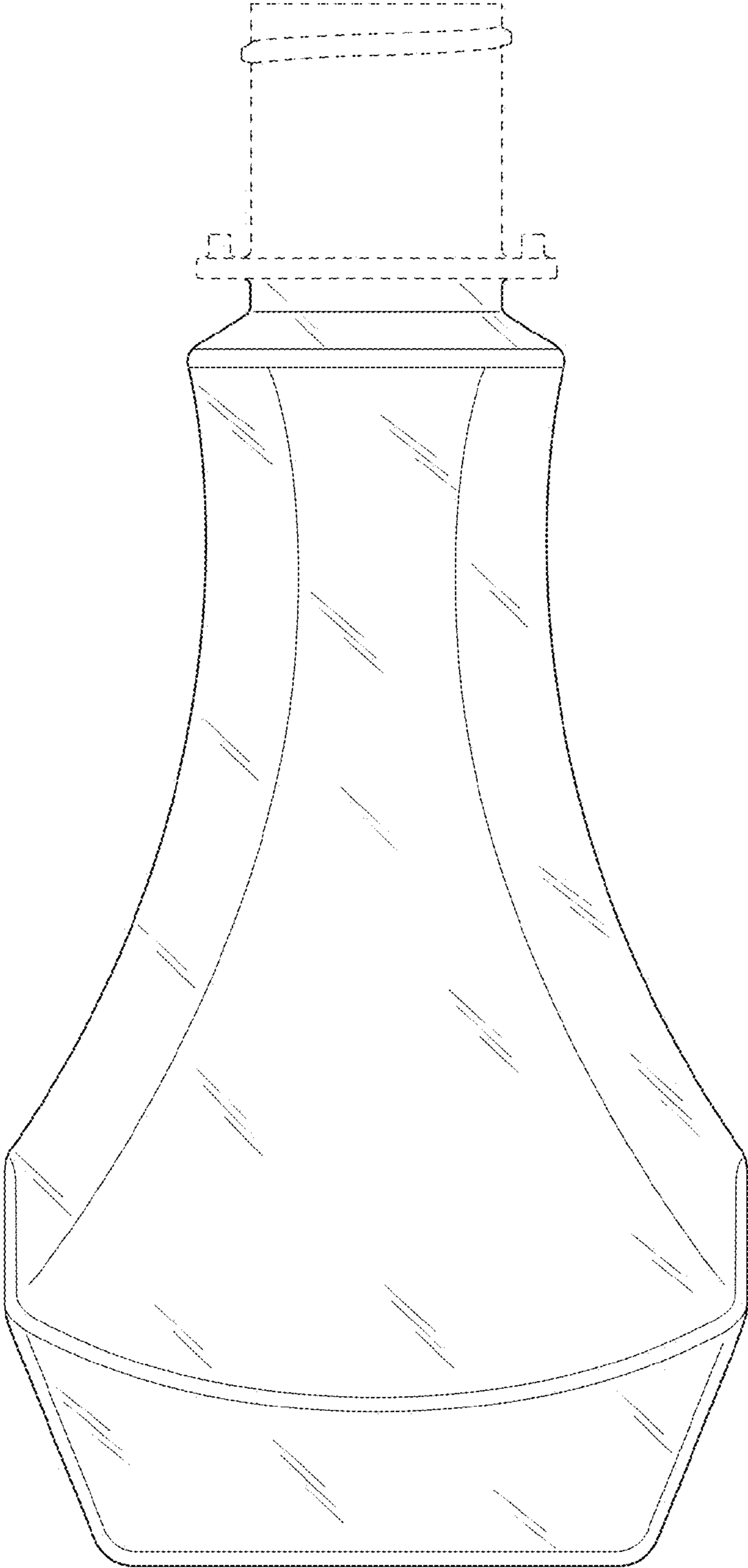

Fig. 5

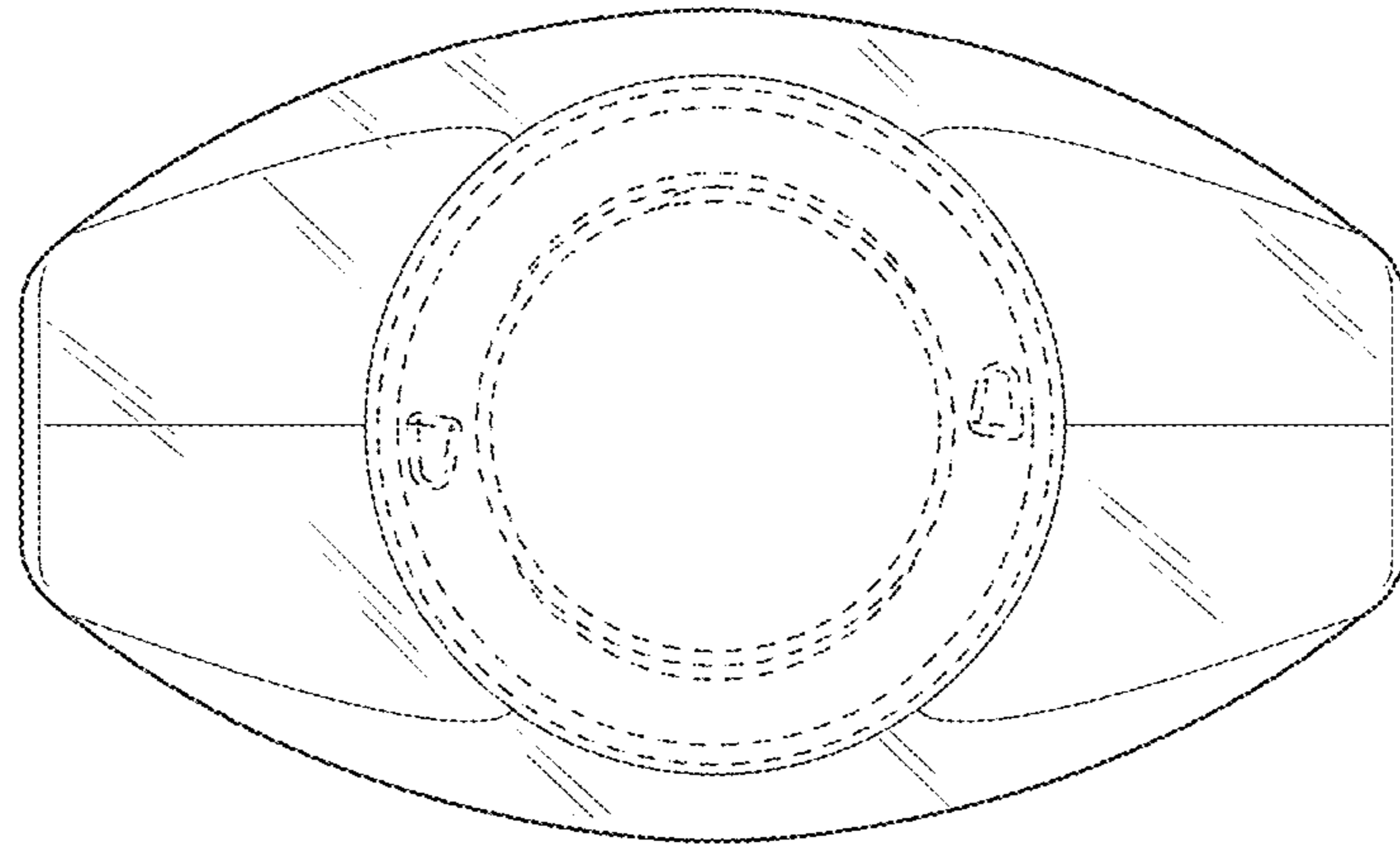

Fig. 6

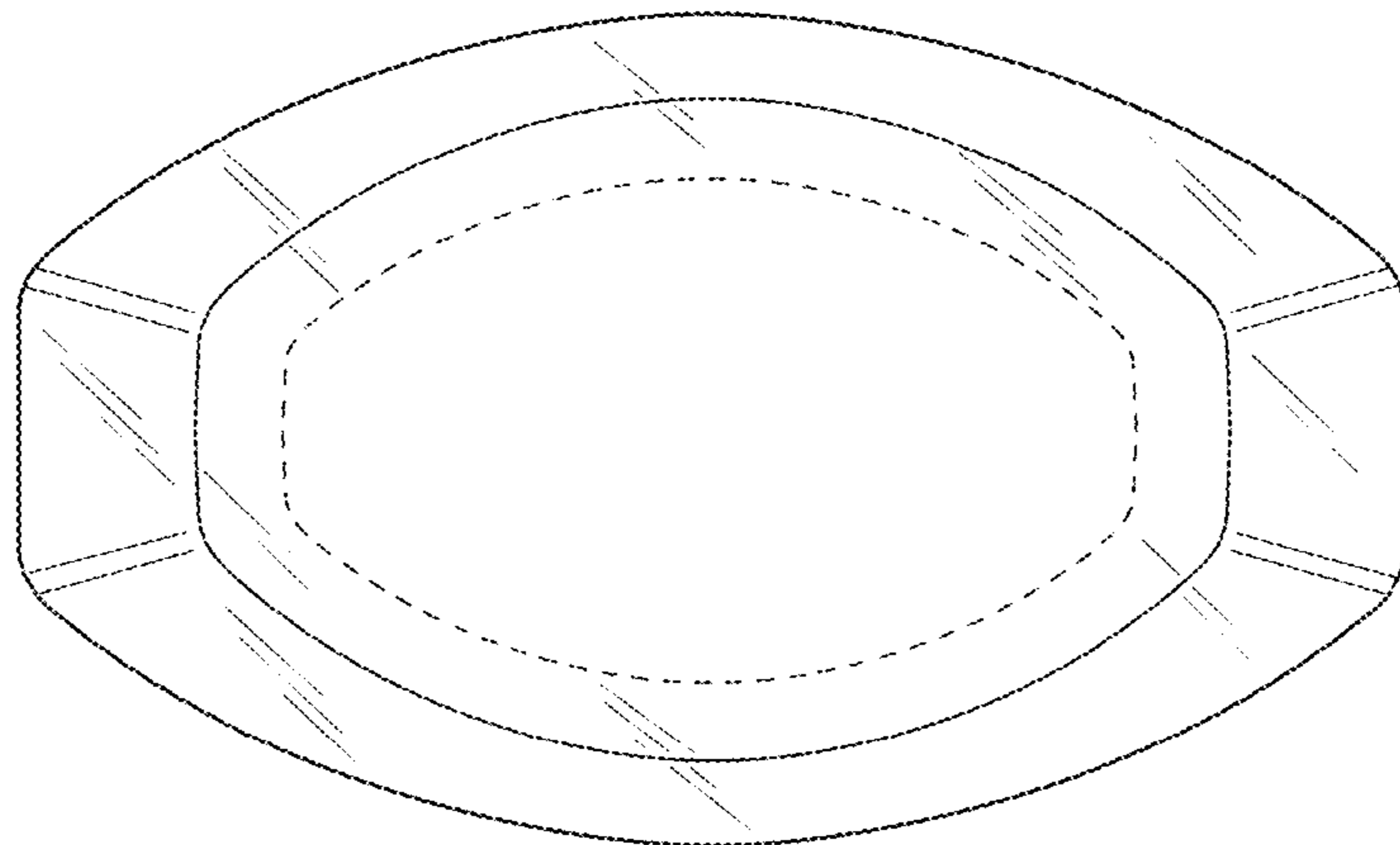

Fig. 7

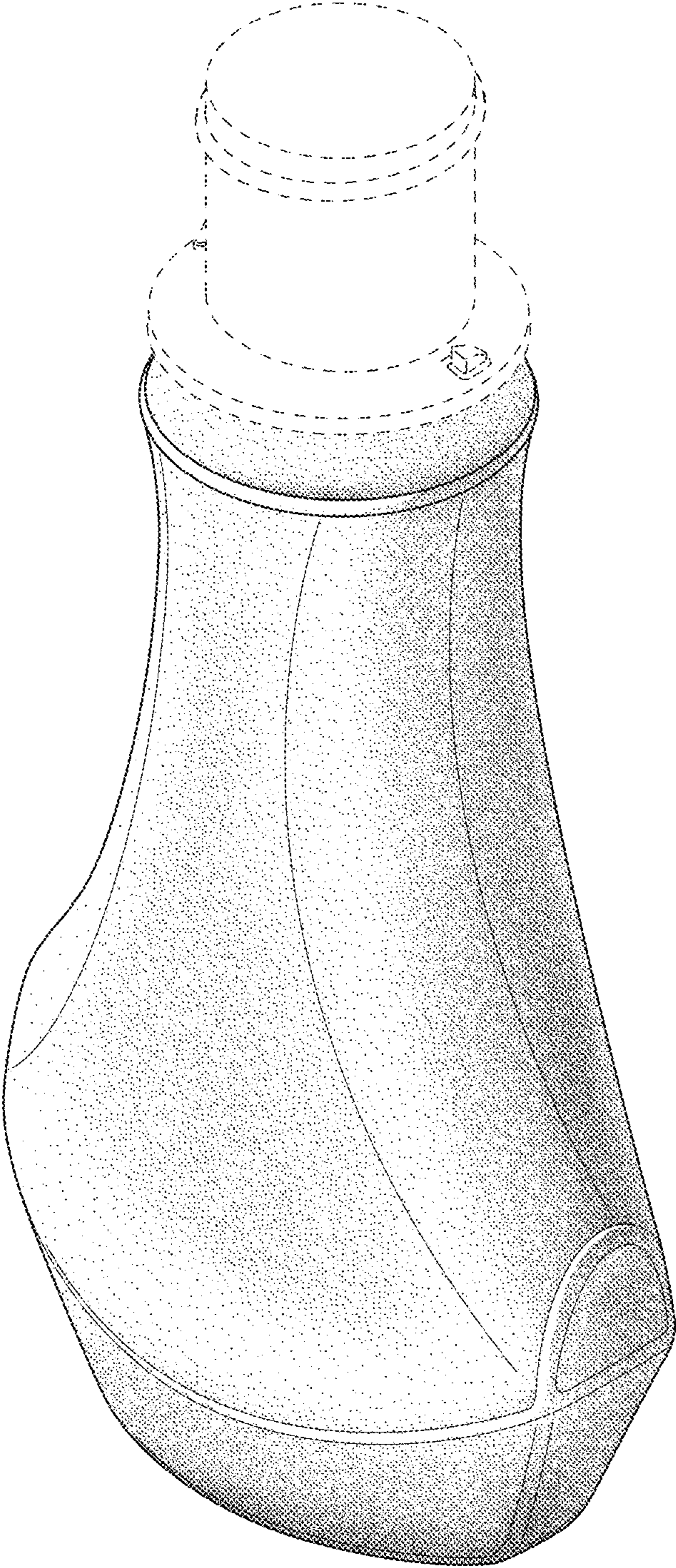

Fig. 8

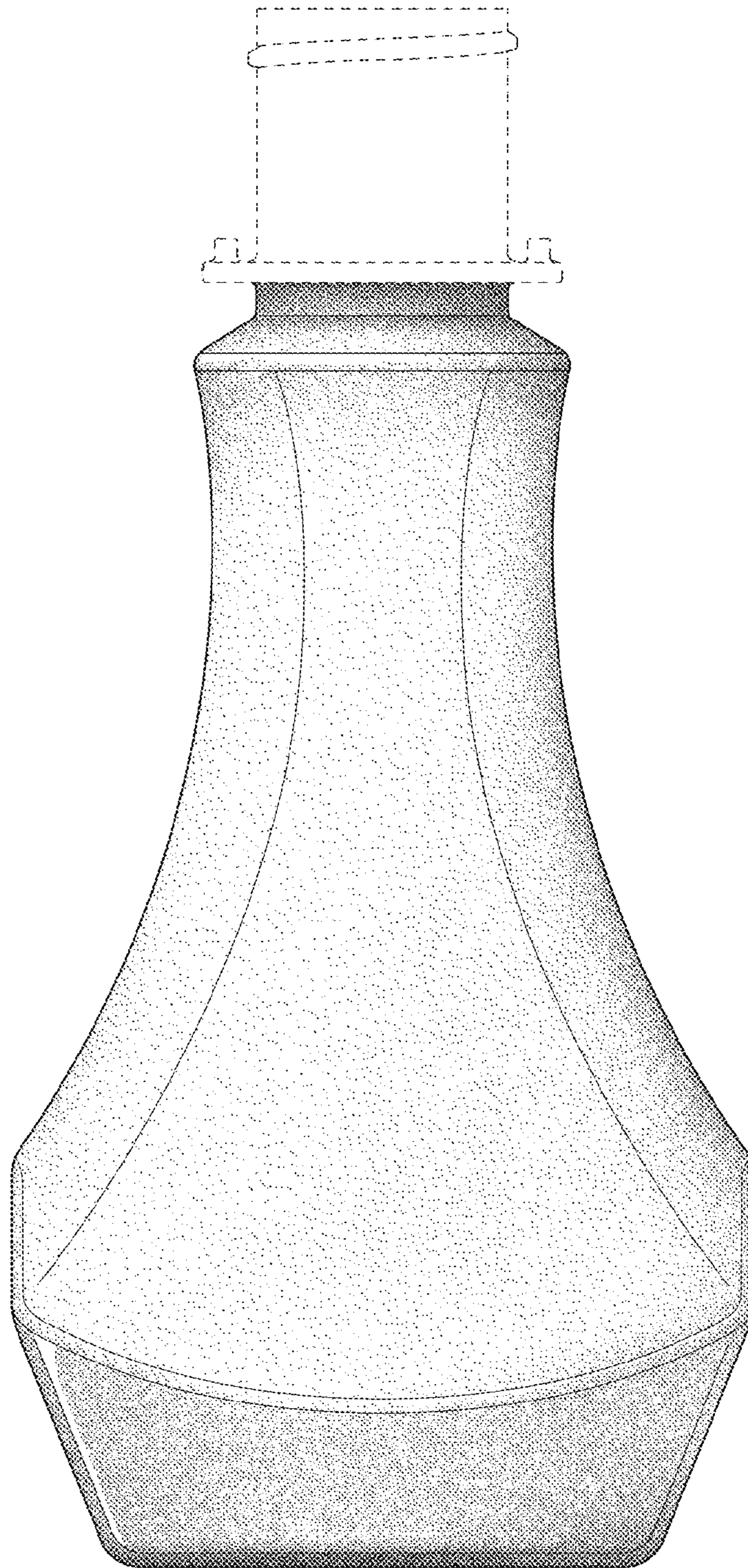

Fig. 9

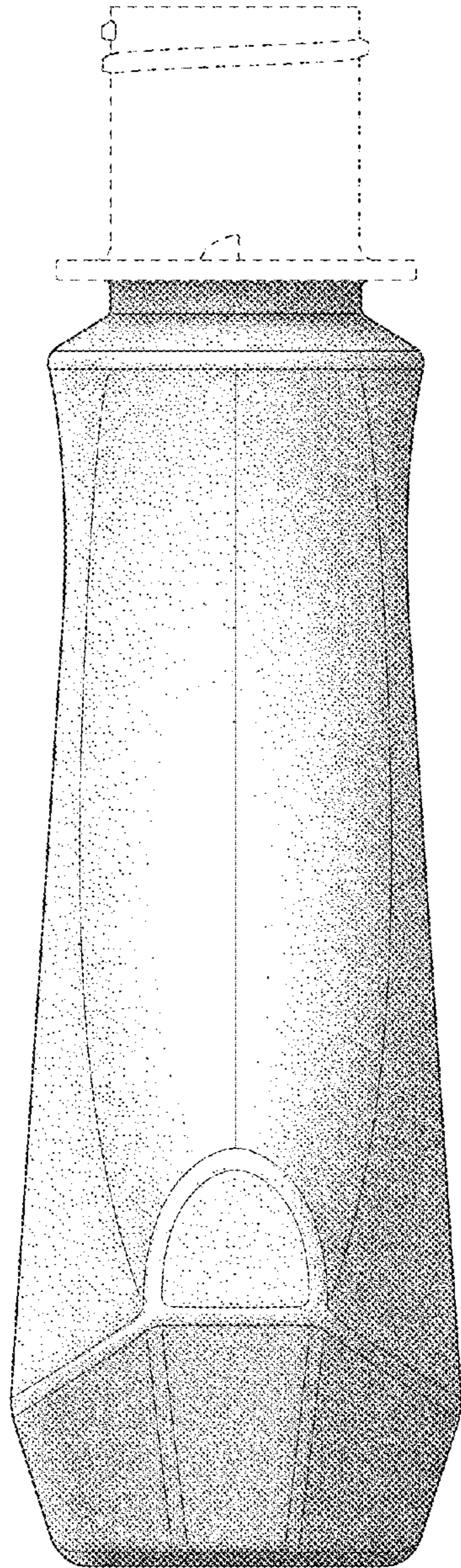

Fig. 10

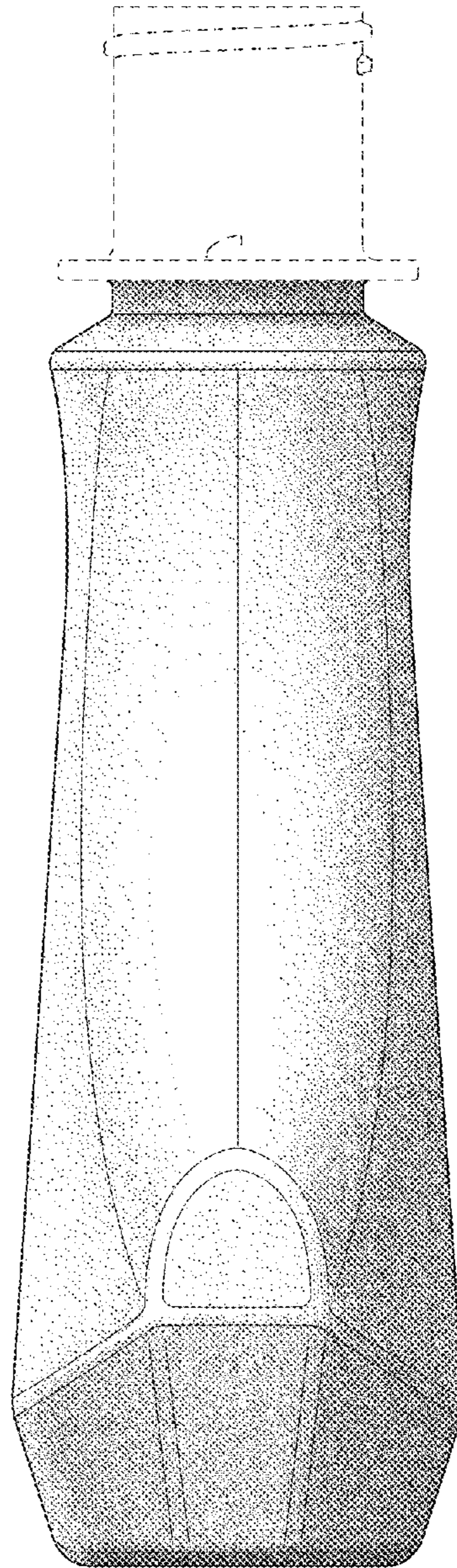

Fig. 11

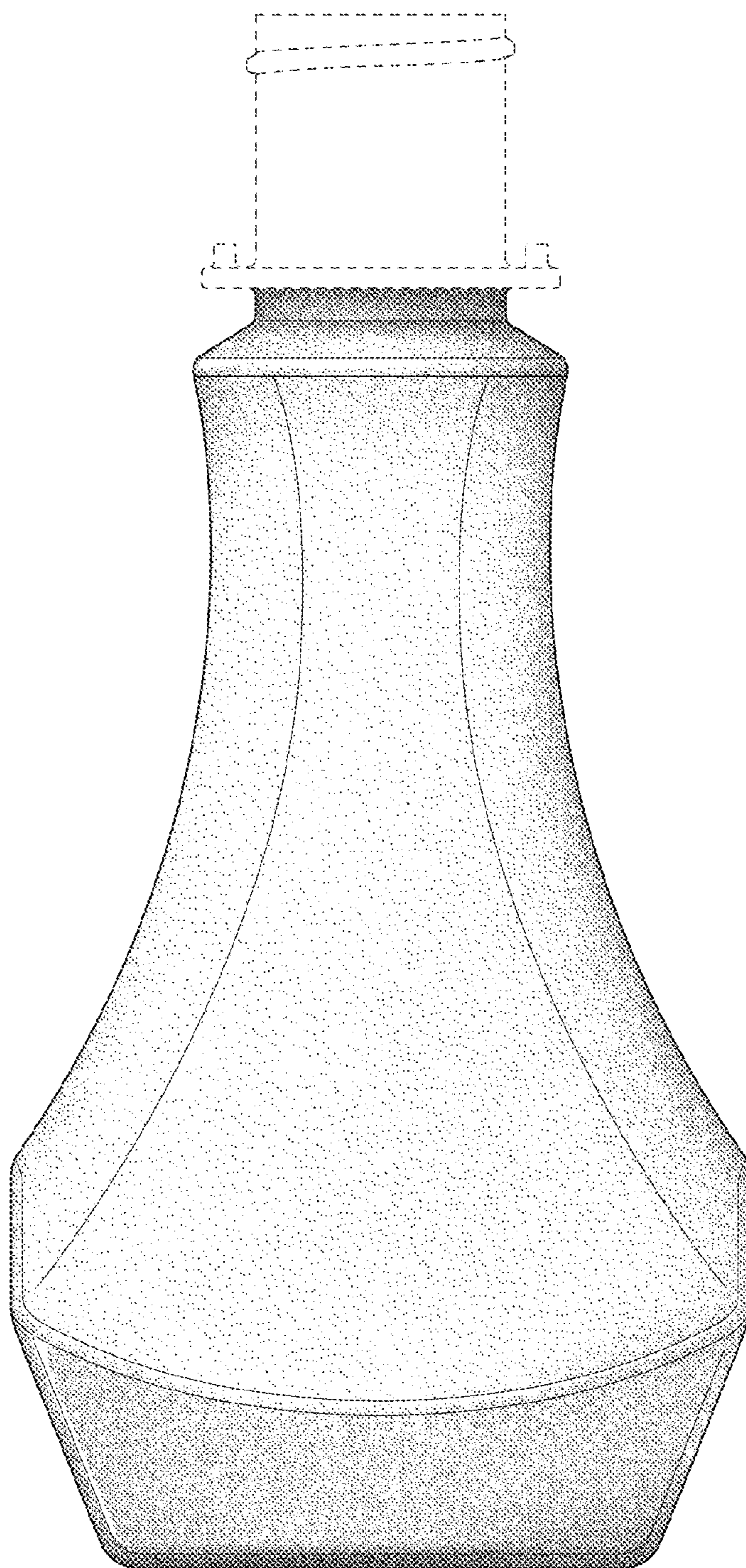

Fig. 12

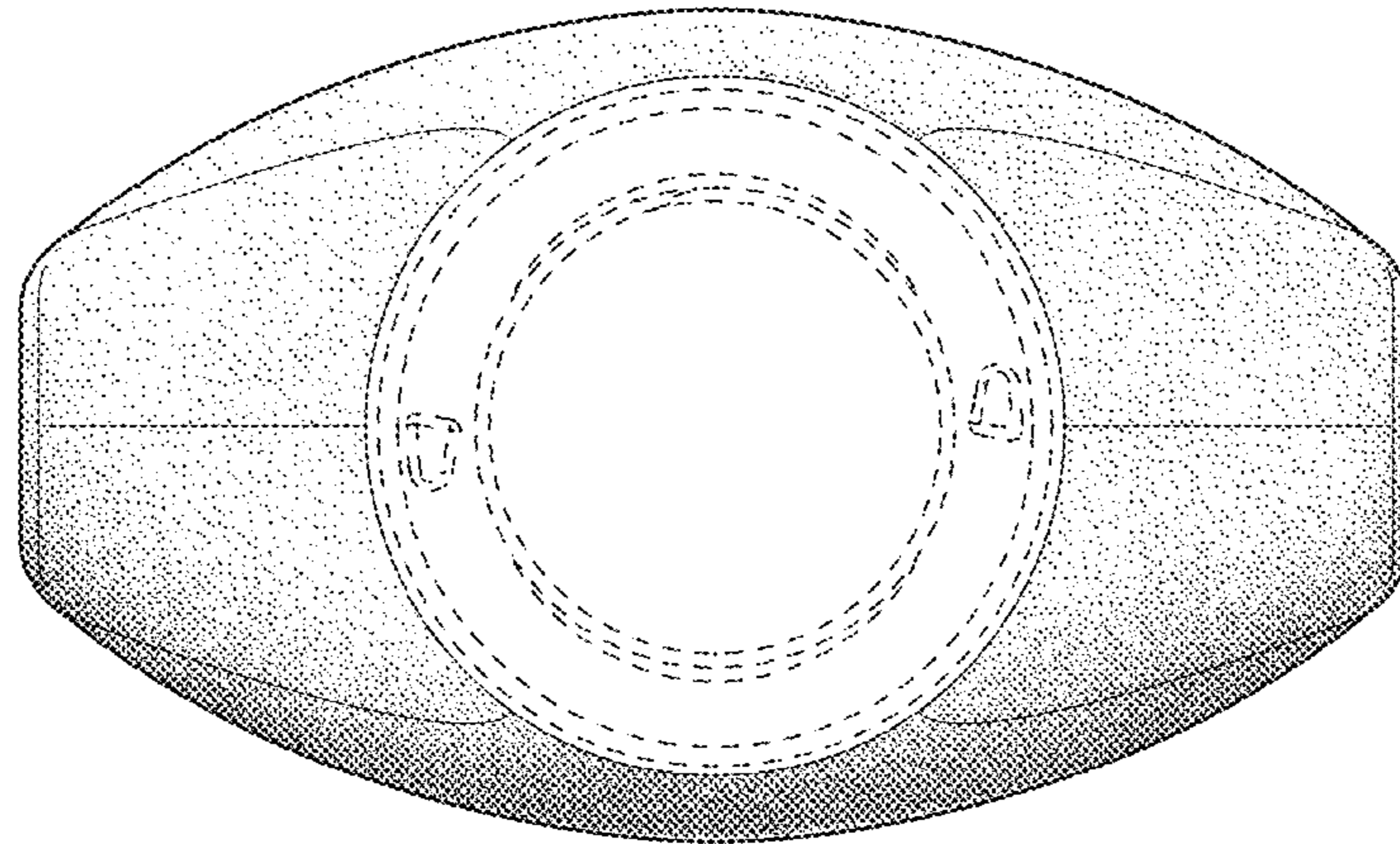

Fig. 13

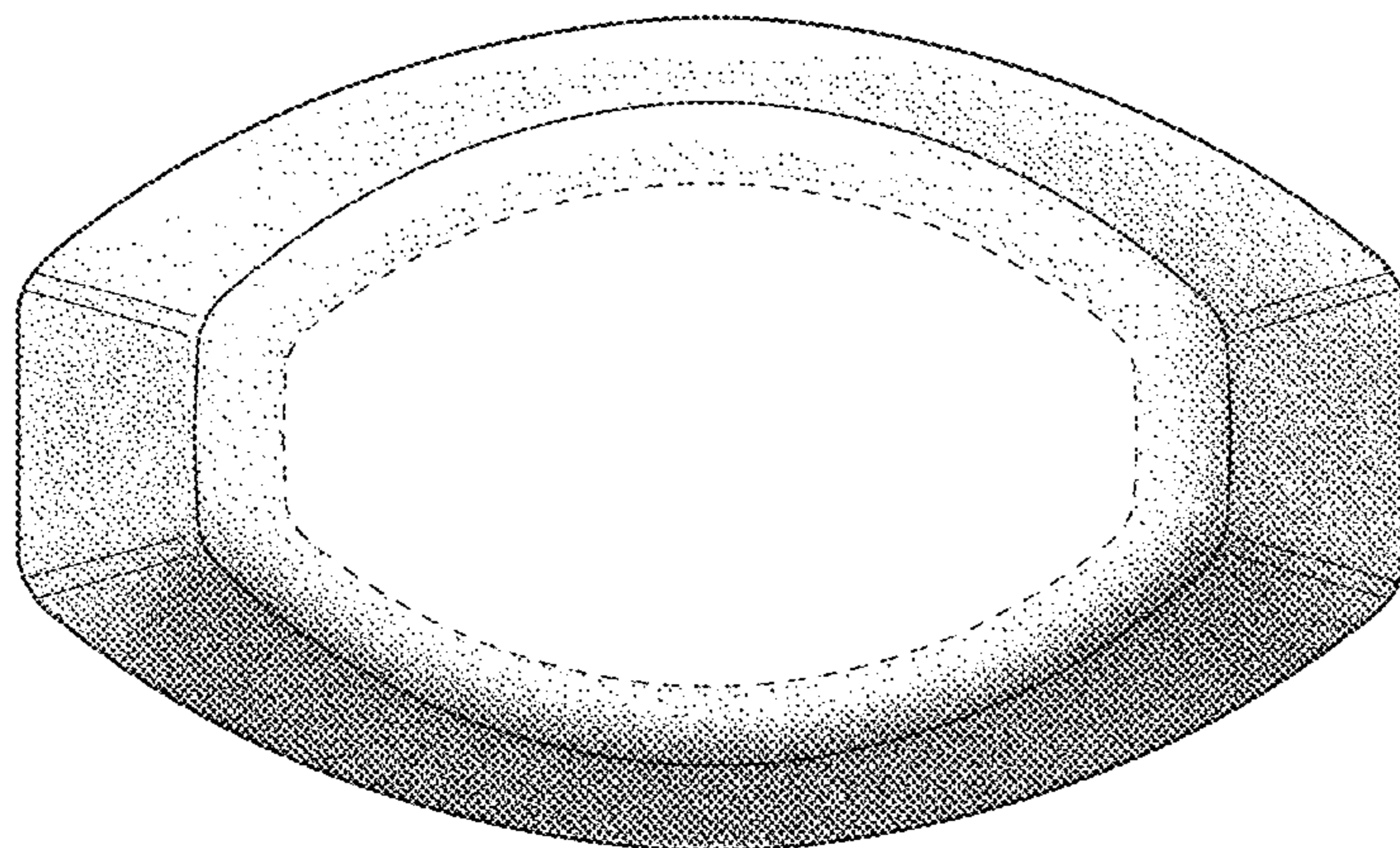

Fig. 14