

US00D695619S

(12) **United States Design Patent**  
**Hoeke et al.**

(10) **Patent No.:** **US D695,619 S**

(45) **Date of Patent:** **\*\* Dec. 17, 2013**

(54) **BOTTLE**

(71) Applicant: **LRC Products Ltd.**, Berkshire (GB)

(72) Inventors: **Rens Hoeke**, Eindhoven (NL); **Tuen Franciscus van Wetten**, Eindhoven (NL)

(73) Assignee: **LRC Products Ltd.**, Slough, Berkshire (GB)

(\*\*) Term: **14 Years**

(21) Appl. No.: **29/446,007**

(22) Filed: **Feb. 19, 2013**

(30) **Foreign Application Priority Data**

Aug. 20, 2012 (EM) ..... 002089797-0001

Aug. 20, 2012 (EM) ..... 002089797-0002

(51) **LOC (9) Cl.** ..... **09-01**

(52) **U.S. Cl.**  
USPC ..... **D9/521**; D9/449; D9/529; D9/743

(58) **Field of Classification Search**  
USPC ..... D9/435, 446-447, 449, 450, 516,  
D9/521-523, 529, 543, 549, 551-552,  
D9/564-565, 571-572, 682, 686-687,  
D9/692-694; D14/402, 408; 215/379,  
215/381-382; 220/660, 662, 669-673, 675

See application file for complete search history.

(56) **References Cited**

U.S. PATENT DOCUMENTS

D265,626 S \* 8/1982 Kozłowski ..... D9/724  
D280,077 S \* 8/1985 Lemaire ..... D9/522  
D383,972 S \* 9/1997 Weiss ..... D9/686

(Continued)

*Primary Examiner* — Ian Simmons

*Assistant Examiner* — Dana L Meyrow

(74) *Attorney, Agent, or Firm* — Ryan A. Schneider;  
Troutman Sanders LLP

(57) **CLAIM**

We claim the ornamental design for a bottle, as shown and described.

**DESCRIPTION**

FIG. 1 is a top perspective view of a bottle according to a first embodiment of the present invention;

FIG. 2 is a side view of the bottle of FIG. 1;

FIG. 3 is the other side view of the bottle of FIG. 1;

FIG. 4 is a front view of the bottle of FIG. 1;

FIG. 5 is a back view of the bottle of FIG. 1;

FIG. 6 is a top view of the bottle of FIG. 1;

FIG. 7 is a bottom view of the bottle of FIG. 1;

FIG. 8 is a top perspective view of a bottle according to a second embodiment of the present invention, wherein two bottles of the first embodiment are cooperatively coupled together;

FIG. 9 is a side view of the bottle of FIG. 8;

FIG. 10 is the other side view of the bottle of FIG. 8;

FIG. 11 is a front view of the bottle of FIG. 8;

FIG. 12 is a back view of the bottle of FIG. 8;

FIG. 13 is a top view of the bottle of FIG. 8; and,

FIG. 14 is a bottom view of the bottle of FIG. 8.

The broken lines in the drawings showing a second bottle of the same design illustrate environment that forms no part of the claim.

**1 Claim, 4 Drawing Sheets**

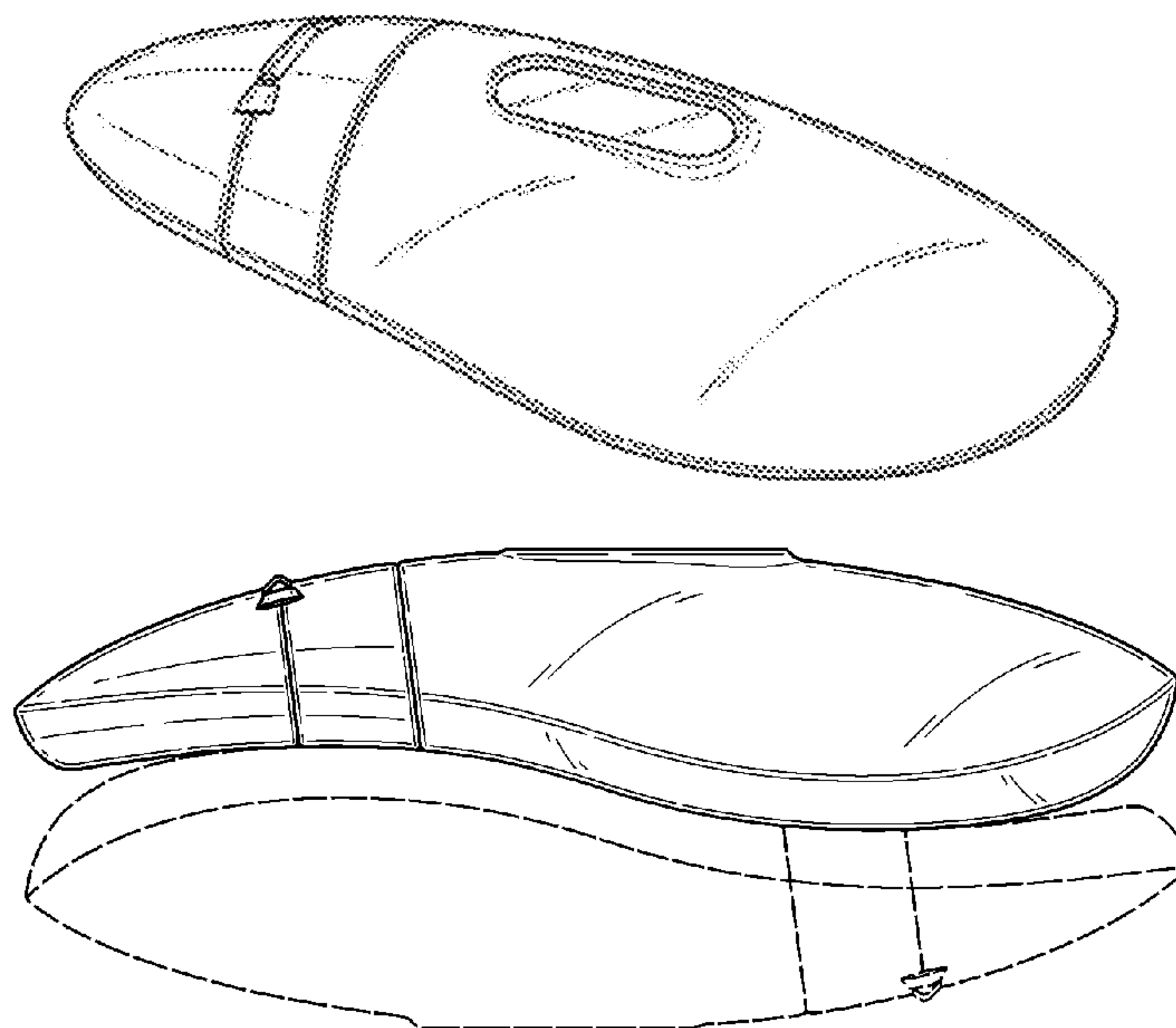

# US D695,619 S

Page 2

---

(56)

## References Cited

### U.S. PATENT DOCUMENTS

D428,816 S \* 8/2000 Shiokawa et al. .... D9/521  
D441,640 S \* 5/2001 Reinoso ..... D9/686  
D533,185 S \* 12/2006 Ishida et al. .... D14/203.2

D638,714 S \* 5/2011 de Cleir et al. .... D9/529  
D638,715 S \* 5/2011 Albaum et al. .... D9/529  
D651,903 S \* 1/2012 Teller ..... D9/521  
D653,547 S \* 2/2012 Canuto ..... D9/519  
D673,454 S \* 1/2013 Hampole et al. .... D9/516

\* cited by examiner

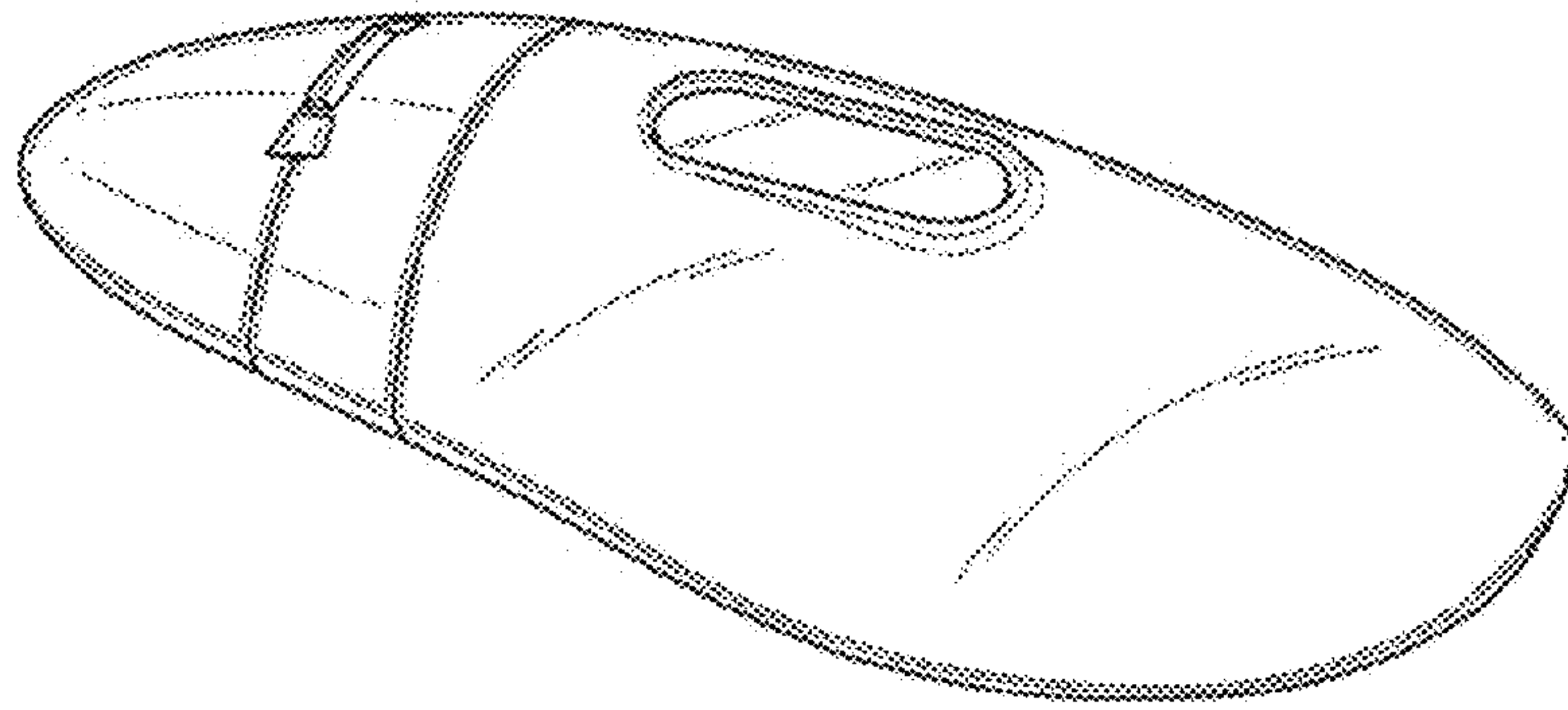

Fig. 1



Fig. 2

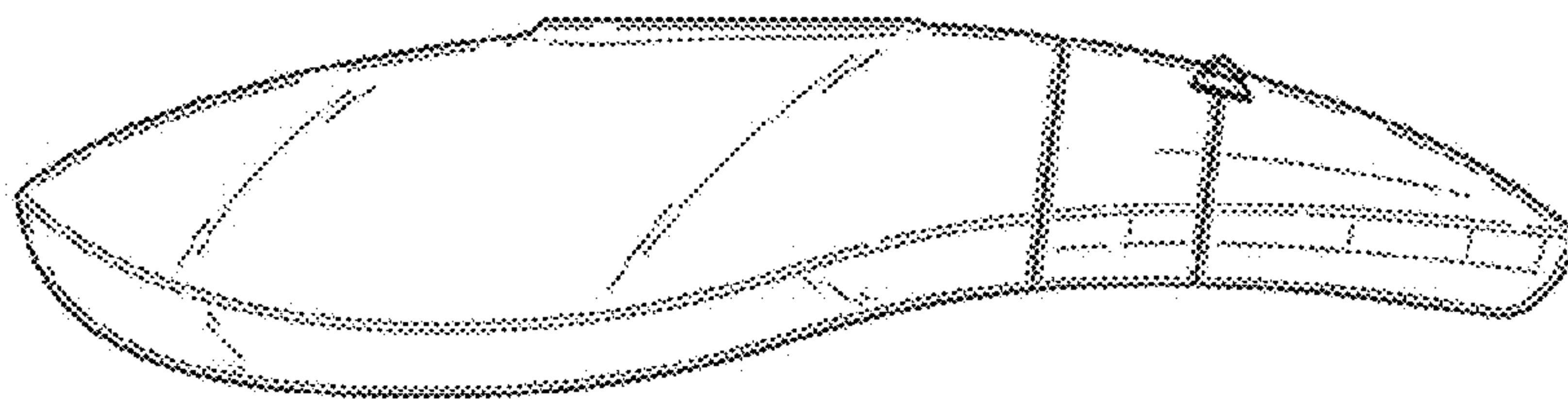

Fig. 3

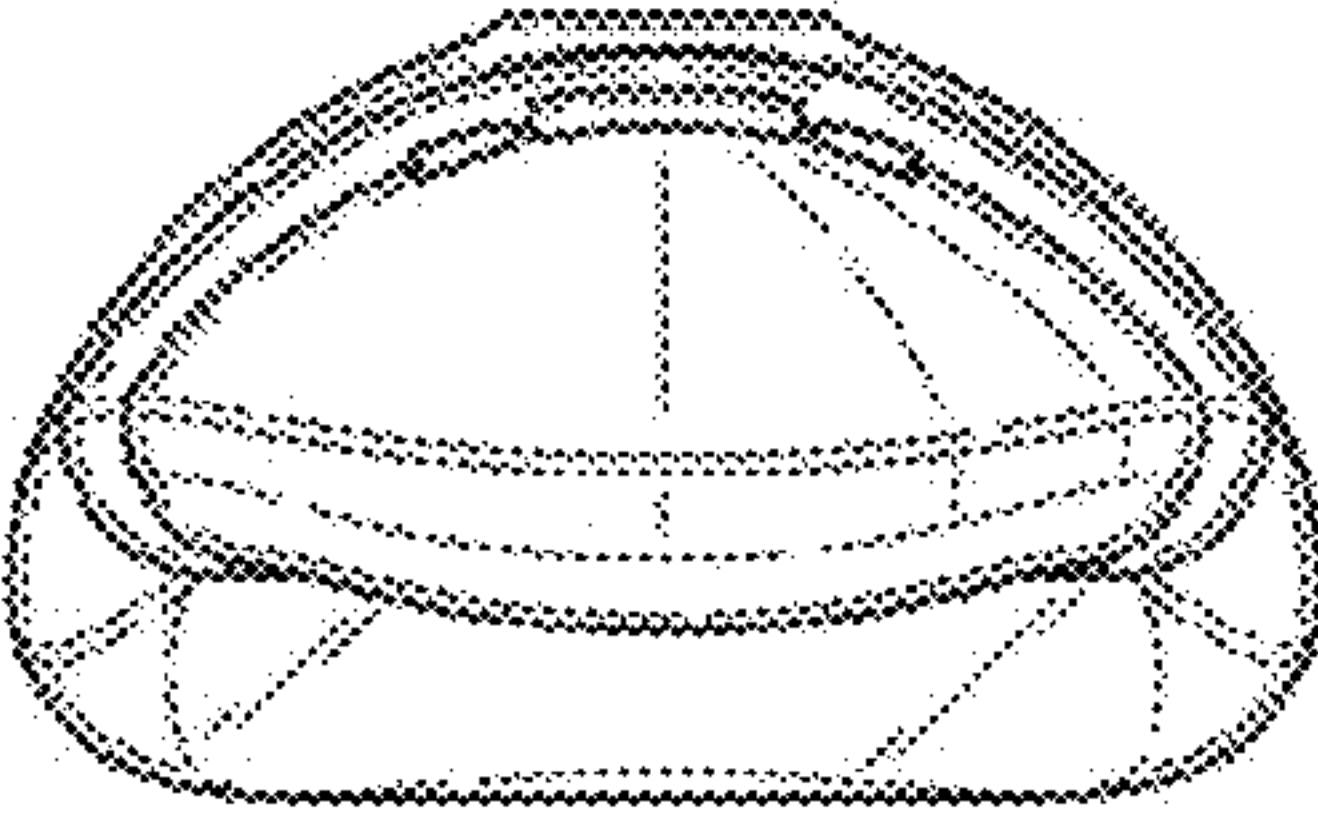

Fig. 4

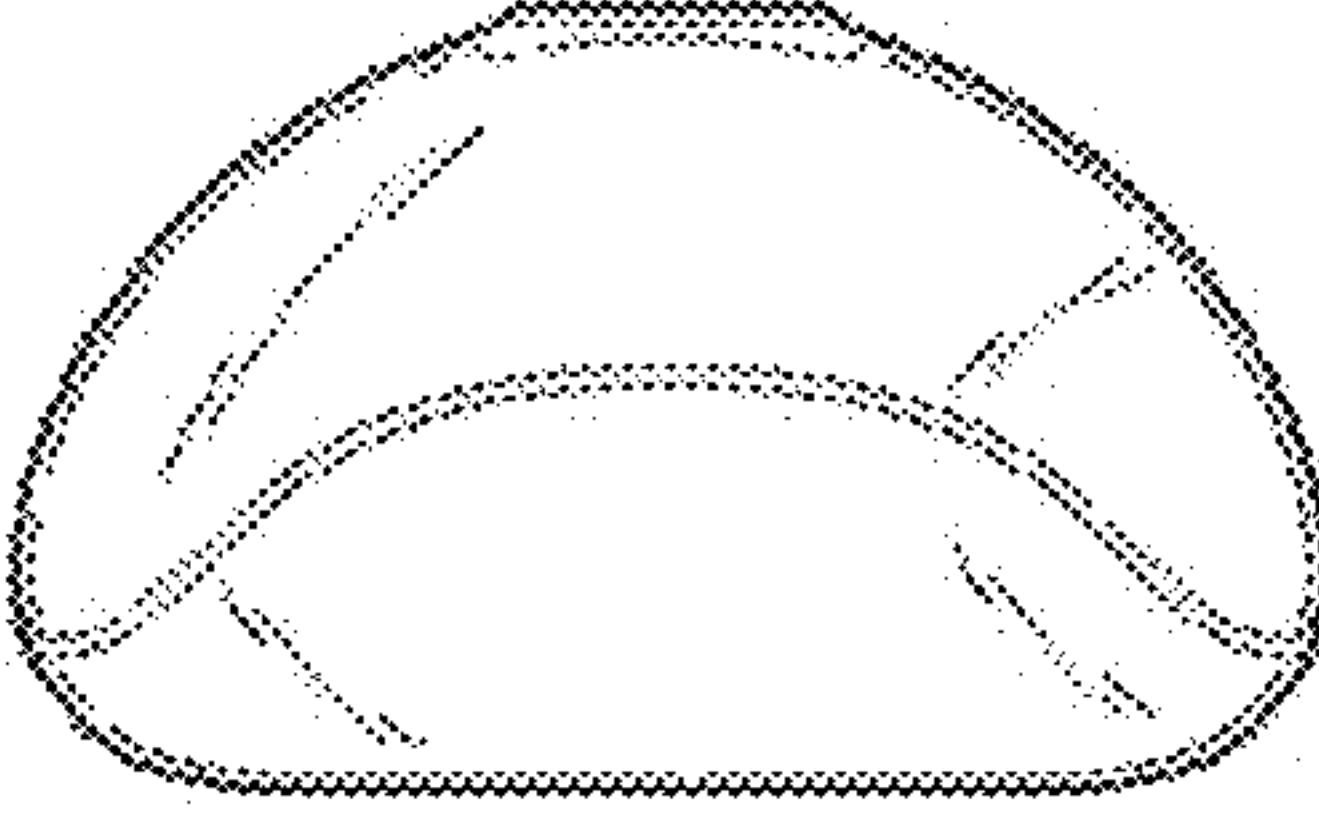

Fig. 5

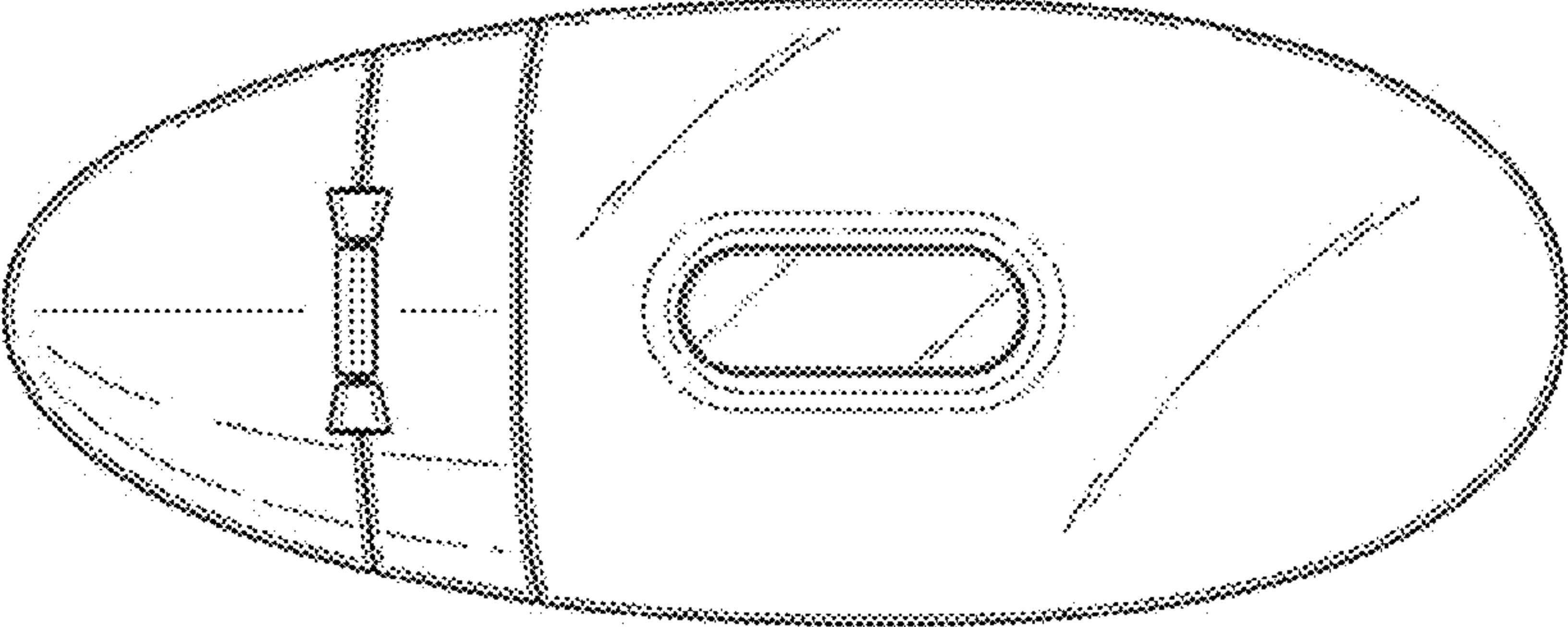

Fig. 6

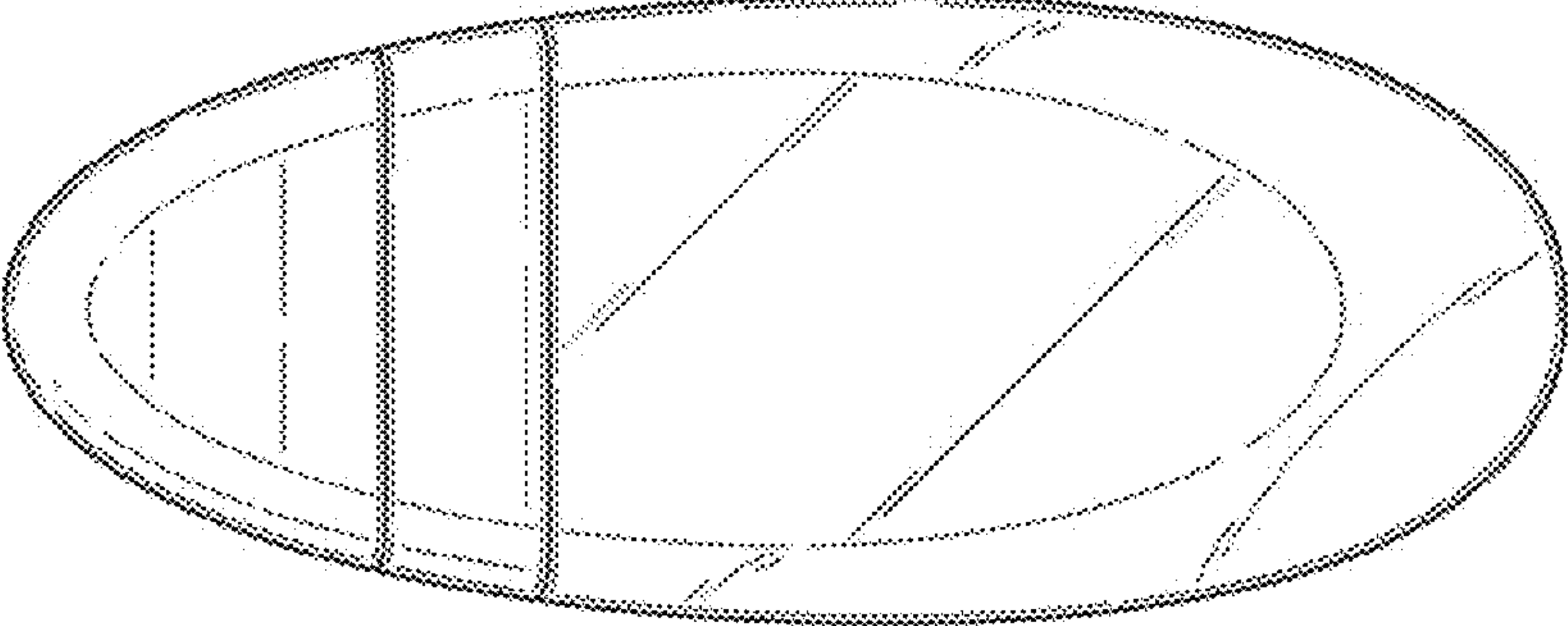

Fig. 7



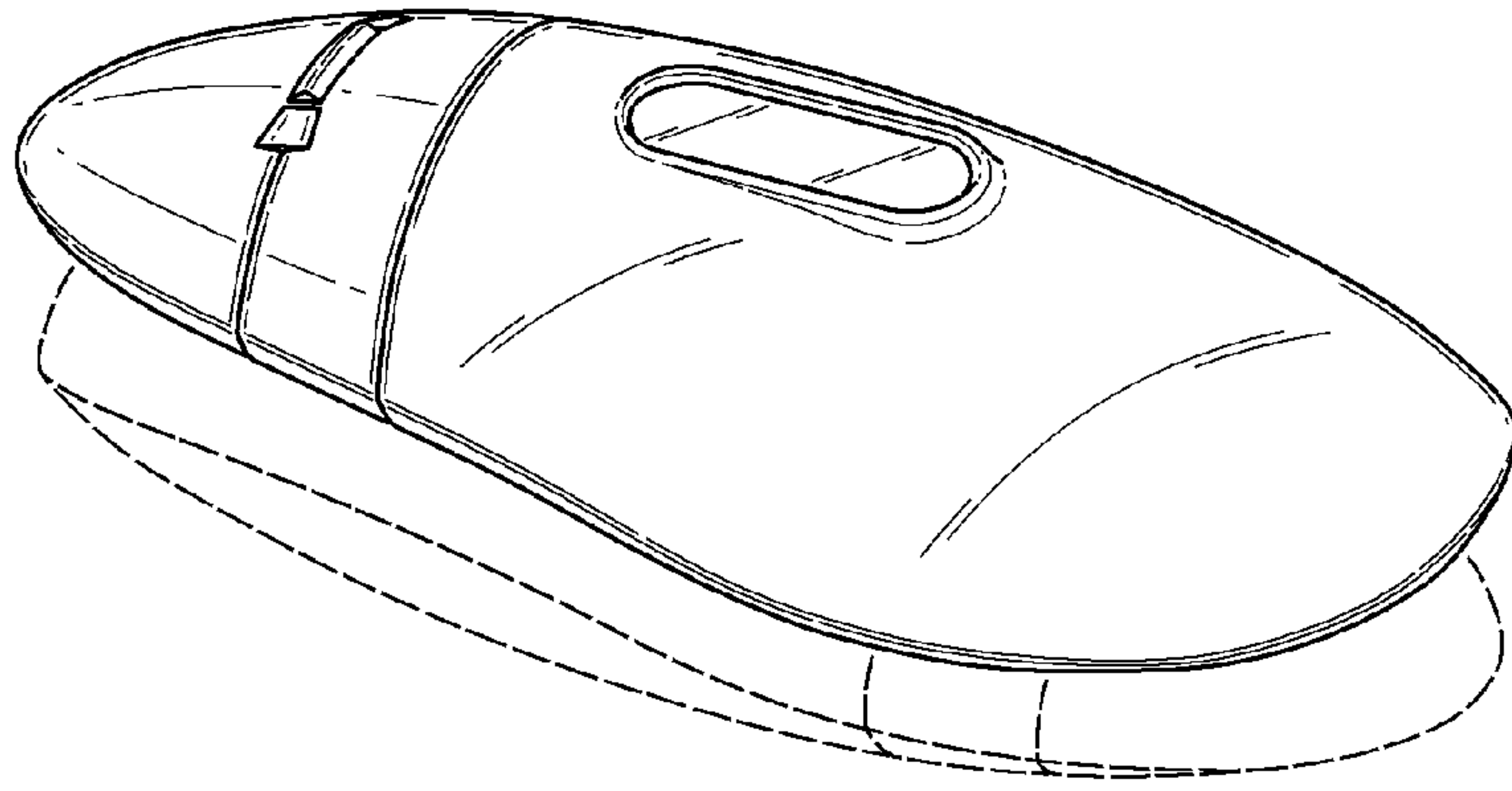

Fig. 8

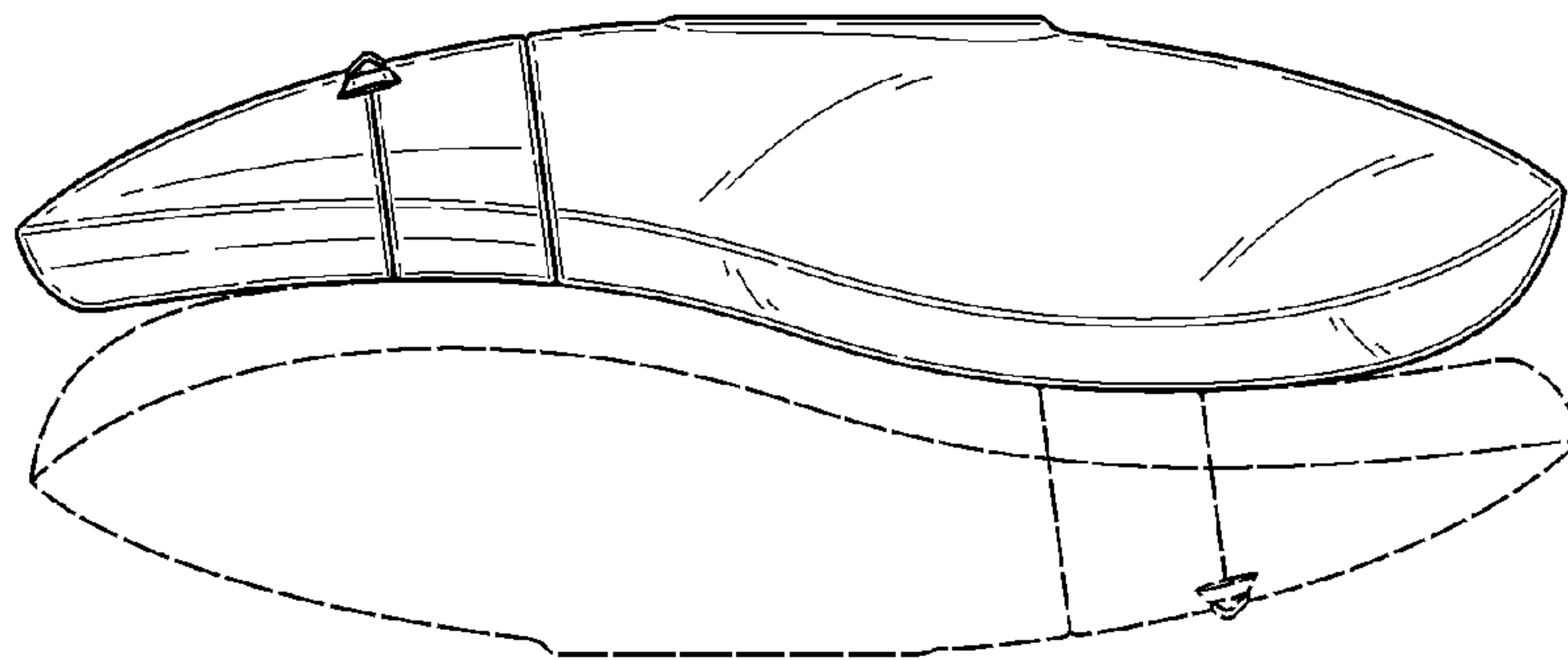

Fig. 9

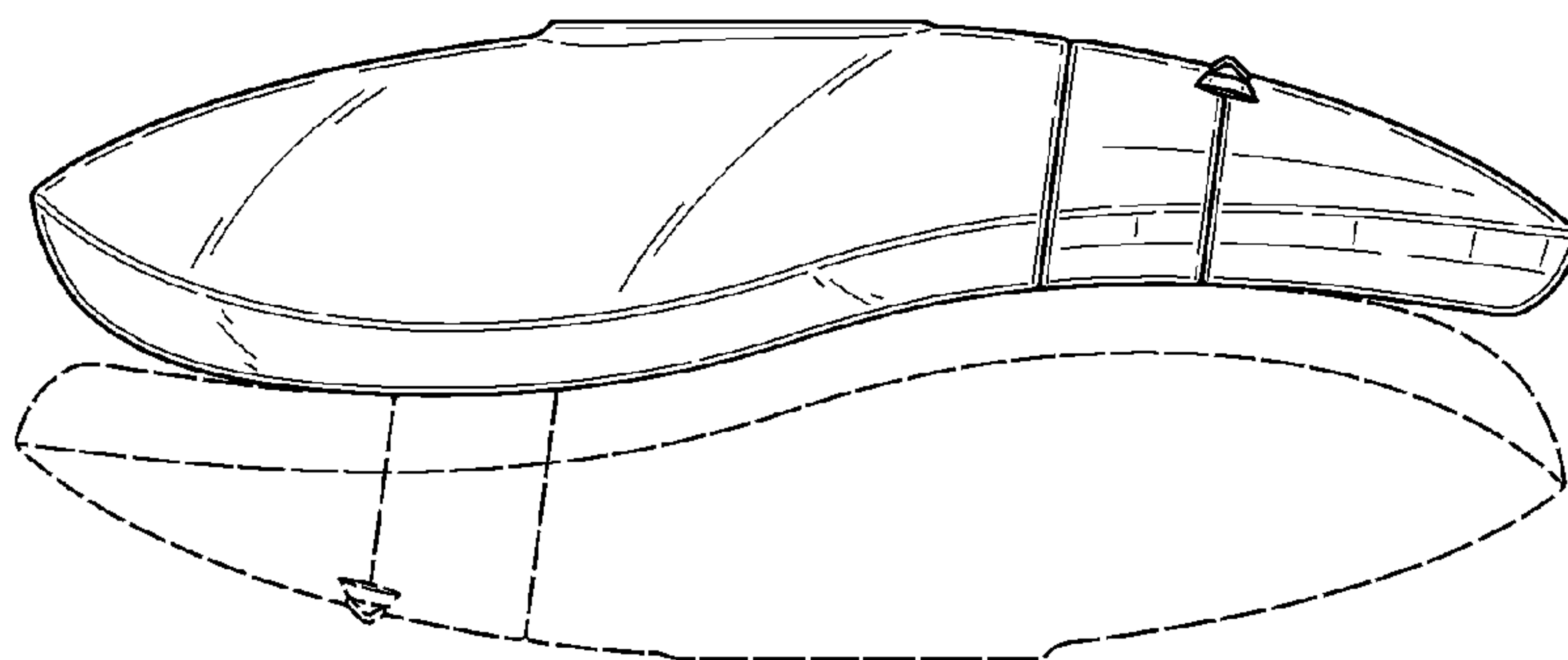

Fig. 10

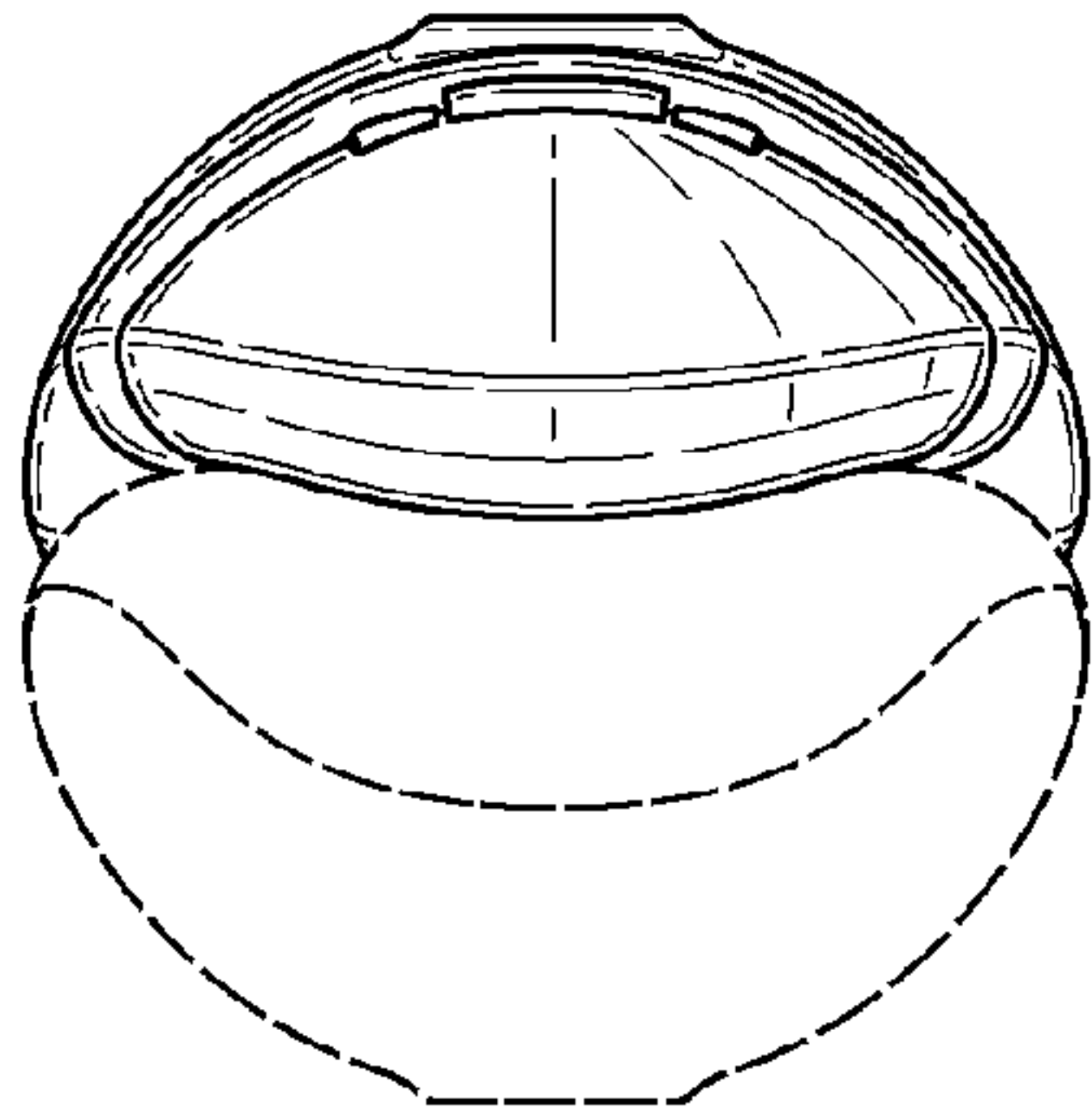

Fig. 11

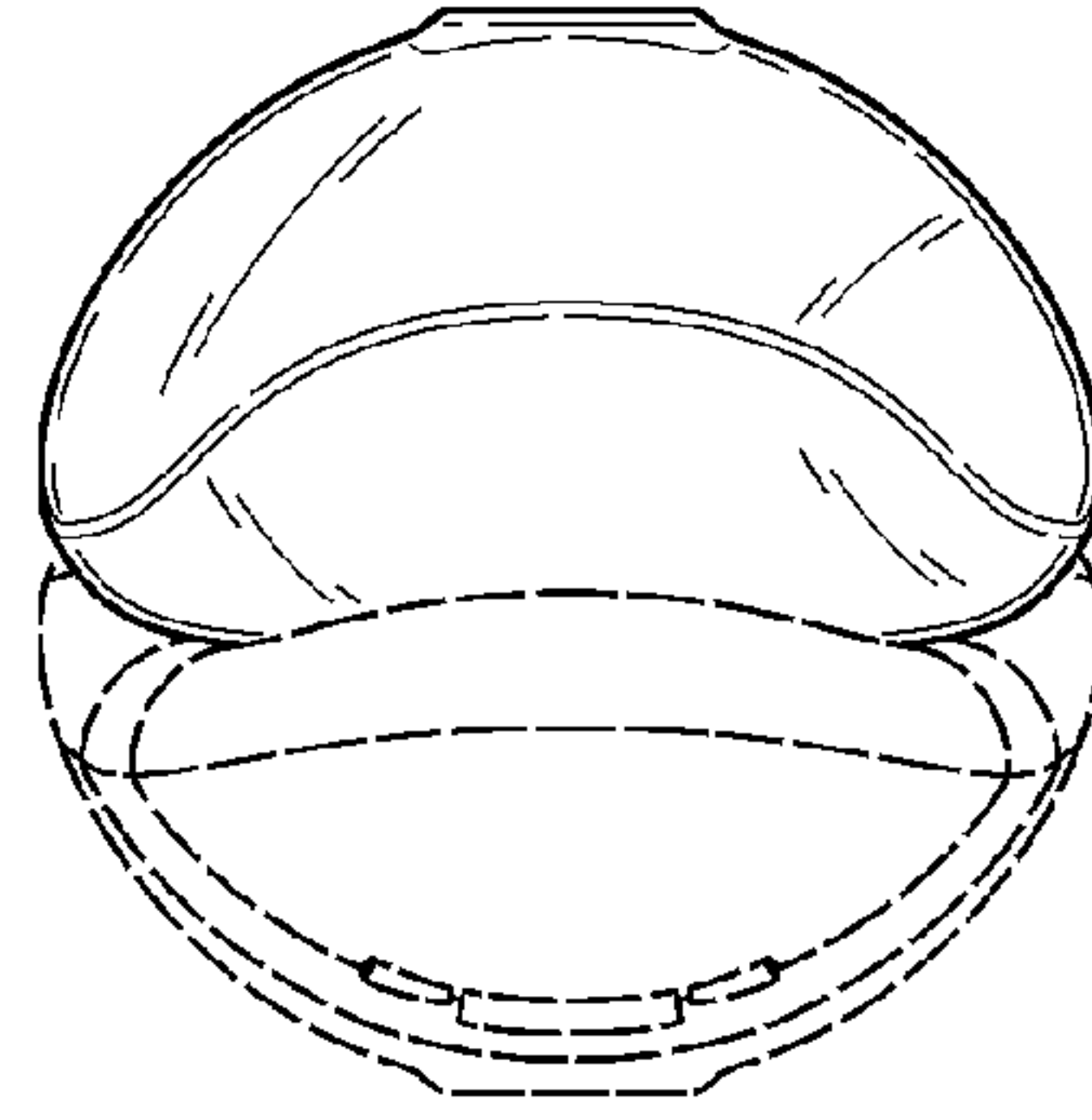

Fig. 12

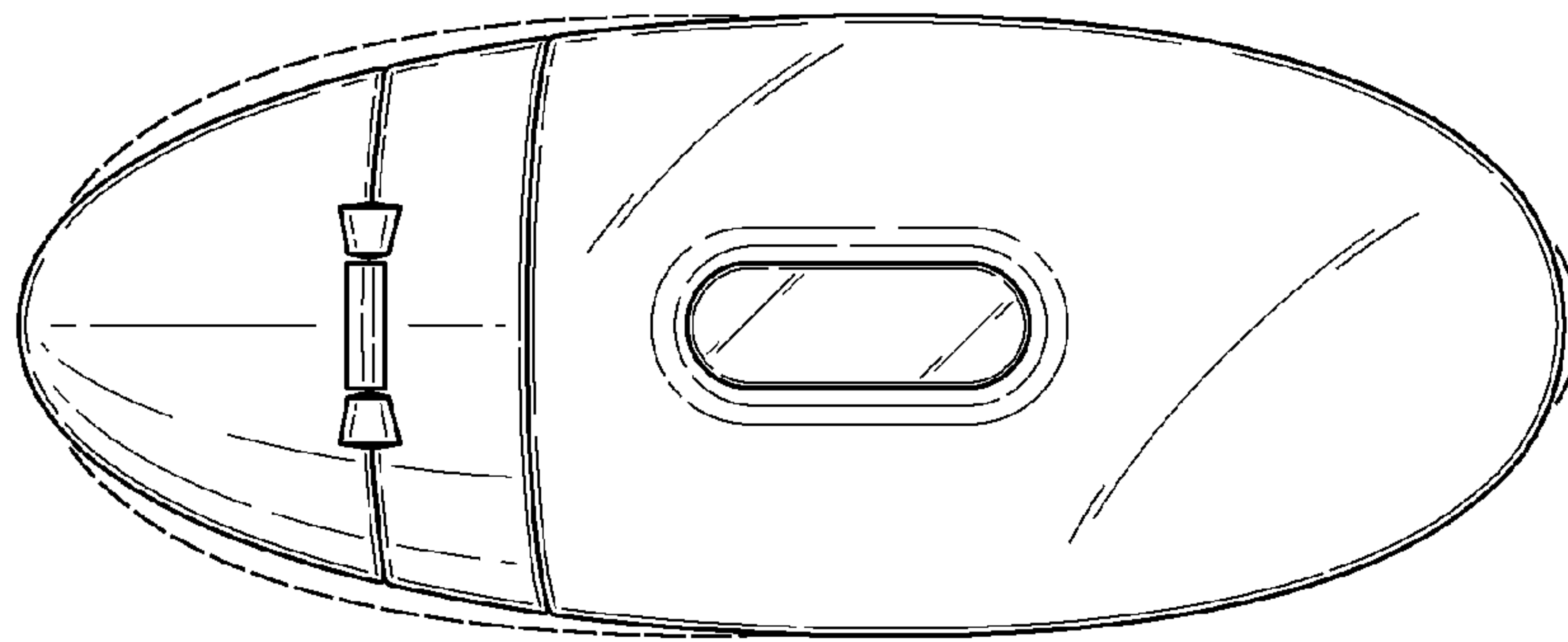

Fig. 13

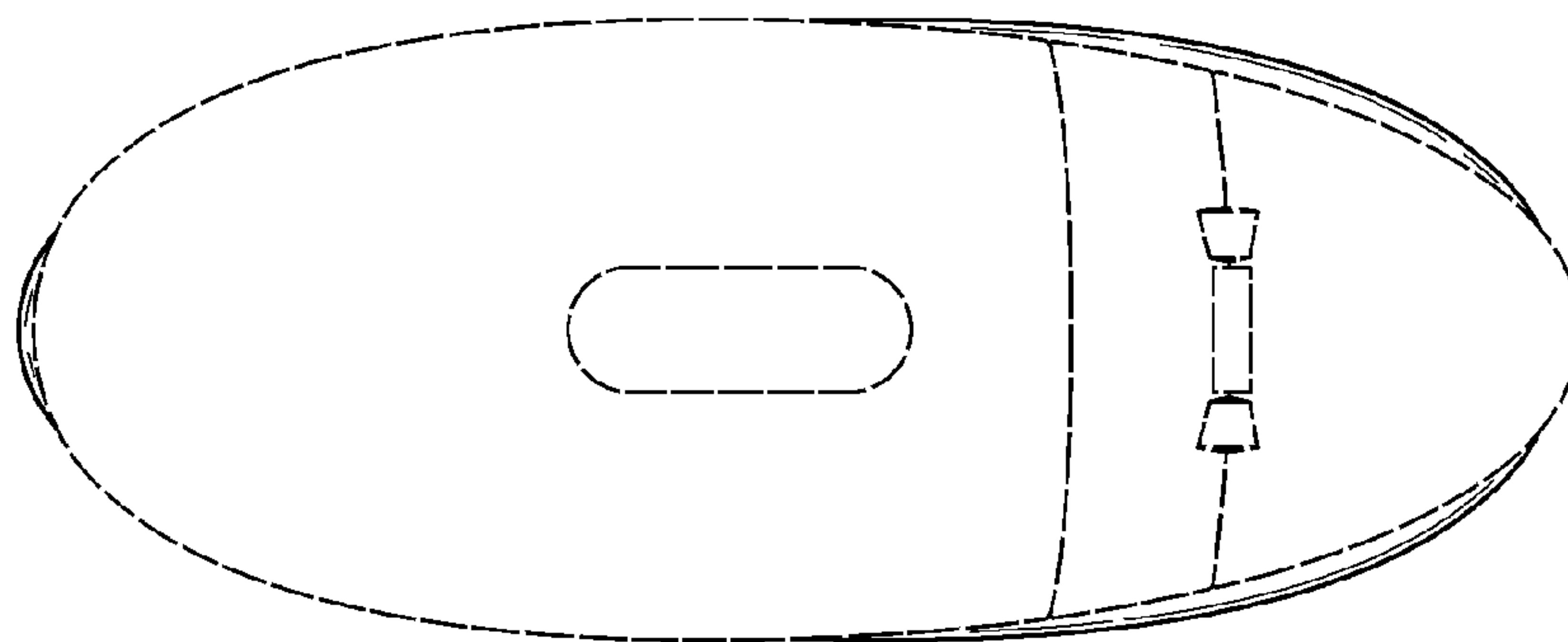

Fig. 14