



US00D695578S

(12) **United States Design Patent**  
**Lee et al.**

(10) **Patent No.:** **US D695,578 S**

(45) **Date of Patent:** **\*\* Dec. 17, 2013**

(54) **BOX GRATER**

(71) Applicant: **Robinson Home Products Inc.**,  
Williamsville, NY (US)

(72) Inventors: **Stuart Harvey Lee**, Forest Hills, NY  
(US); **Jochen Rainer Schaeppers**, New  
York, NY (US)

(73) Assignee: **Robinson Home Products, Inc.**,  
Williamsville, NY (US)

(\*\*) Term: **14 Years**

(21) Appl. No.: **29/447,350**

(22) Filed: **Mar. 1, 2013**

(51) **LOC (9) Cl.** ..... **07-04**

(52) **U.S. Cl.**  
USPC ..... **D7/678**

(58) **Field of Classification Search**  
USPC ..... D7/678, 672-677, 381-385, 412;  
99/495-510; 83/669, 856, 857, 870,  
83/699.51, 699.61, 932; 241/92-95, 100,  
241/168, 169, 169.1, 273.1-273.4, 30, 33,  
241/36, 37.5; 100/234, 98 R, 110; 30/114,  
30/278, 279.6, 280, 286, 287, 383,  
30/389-391

See application file for complete search history.

(56) **References Cited**

**U.S. PATENT DOCUMENTS**

D259,759	S	*	7/1981	Williams	.....	D7/678
5,312,054	A		5/1994	Feer et al.		
D389,019	S	*	1/1998	Molo	.....	D7/678
6,135,375	A	*	10/2000	Kaposi et al.	.....	241/95
D438,433	S	*	3/2001	Kaposi et al.	.....	D7/678
D448,256	S		9/2001	Ancona et al.		
D548,549	S	*	8/2007	Curtin	.....	D7/678
D568,118	S	*	5/2008	Chalfant et al.	.....	D7/678
7,469,848	B2	*	12/2008	Yamanaka et al.	.....	241/95
D593,817	S	*	6/2009	Eide et al.	.....	D7/678
2004/0217219	A1	*	11/2004	Bitonto et al.	.....	241/95
2005/0006505	A1		1/2005	McNeeley et al.		
2006/0283994	A1	*	12/2006	Webb et al.	.....	241/95

2011/0079670 A1\* 4/2011 Ameli et al. .... 241/95

\* cited by examiner

*Primary Examiner* — Terry Wallace

(74) *Attorney, Agent, or Firm* — Florek & Endres PLLC

(57) **CLAIM**

The ornamental design for a box grater, as shown and described.

**DESCRIPTION**

FIG. 1 is a perspective view of the box grater of the present invention shown in a closed configuration.

FIG. 2 is a front elevation view of the box grater of the present invention shown in a closed configuration.

FIG. 3 is a rear elevation view of the box grater of the present invention shown in a closed configuration.

FIG. 4 is a right side elevation view of the box grater of the present invention shown in a closed configuration.

FIG. 5 is a left side elevation view of the box grater of the present invention shown in a closed configuration.

FIG. 6 is a top plan view of the box grater of the present invention shown in a closed configuration.

FIG. 7 is a bottom plan view of the box grater of the present invention shown in a closed configuration.

FIG. 8 is a perspective view of the box grater of the present invention shown in an open configuration.

FIG. 9 is a front elevation view of the box grater of the present invention shown in an open configuration.

FIG. 10 is a rear elevation view of the box grater of the present invention shown in an open configuration.

FIG. 11 is a right side elevation view of the box grater of the present invention shown in an open configuration.

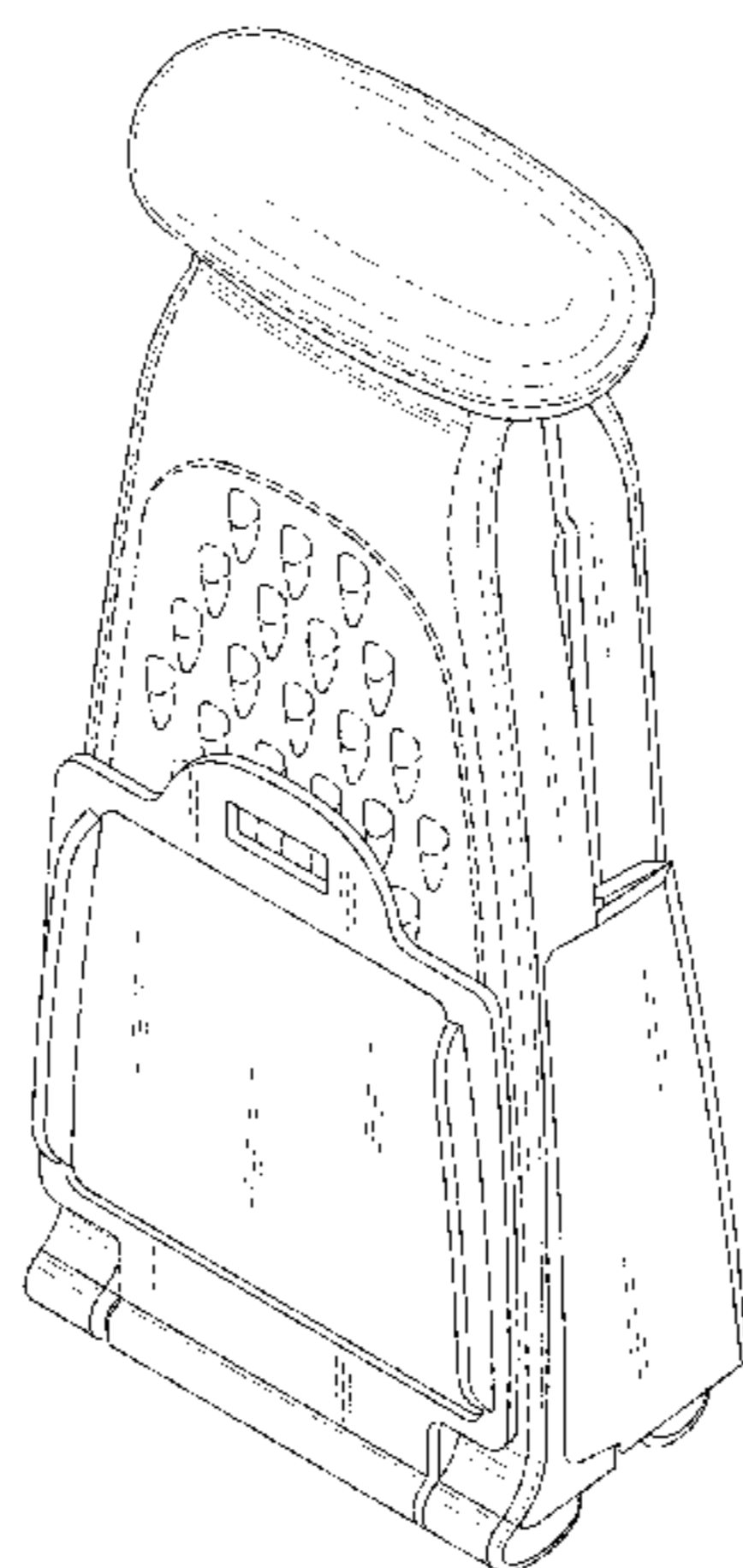
FIG. 12 is a left side elevation view of the box grater of the present invention shown in an open configuration.

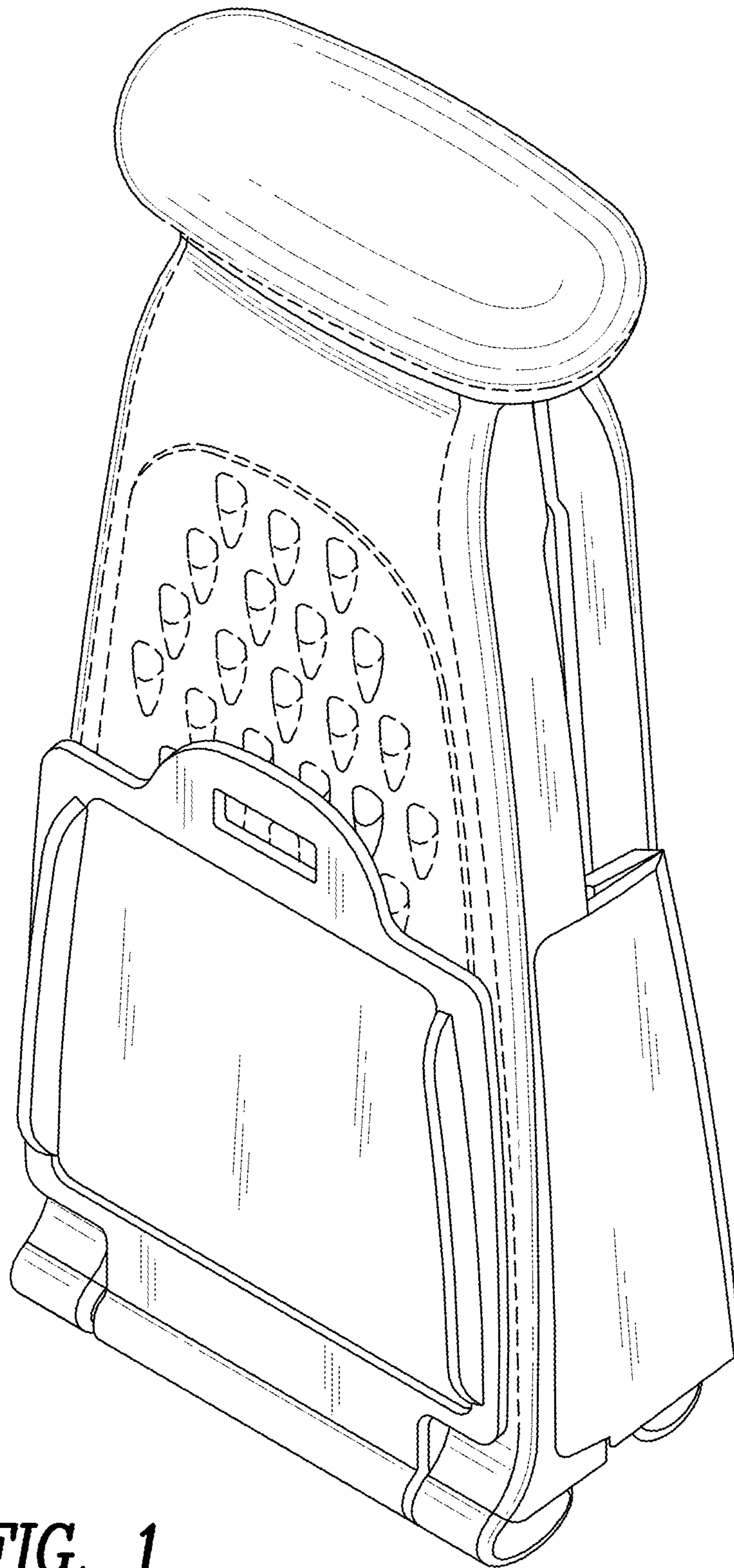
FIG. 13 is a top plan view of the box grater of the present invention shown in an open configuration; and,

FIG. 14 is a bottom plan view of the box grater of the present invention shown in an open configuration.

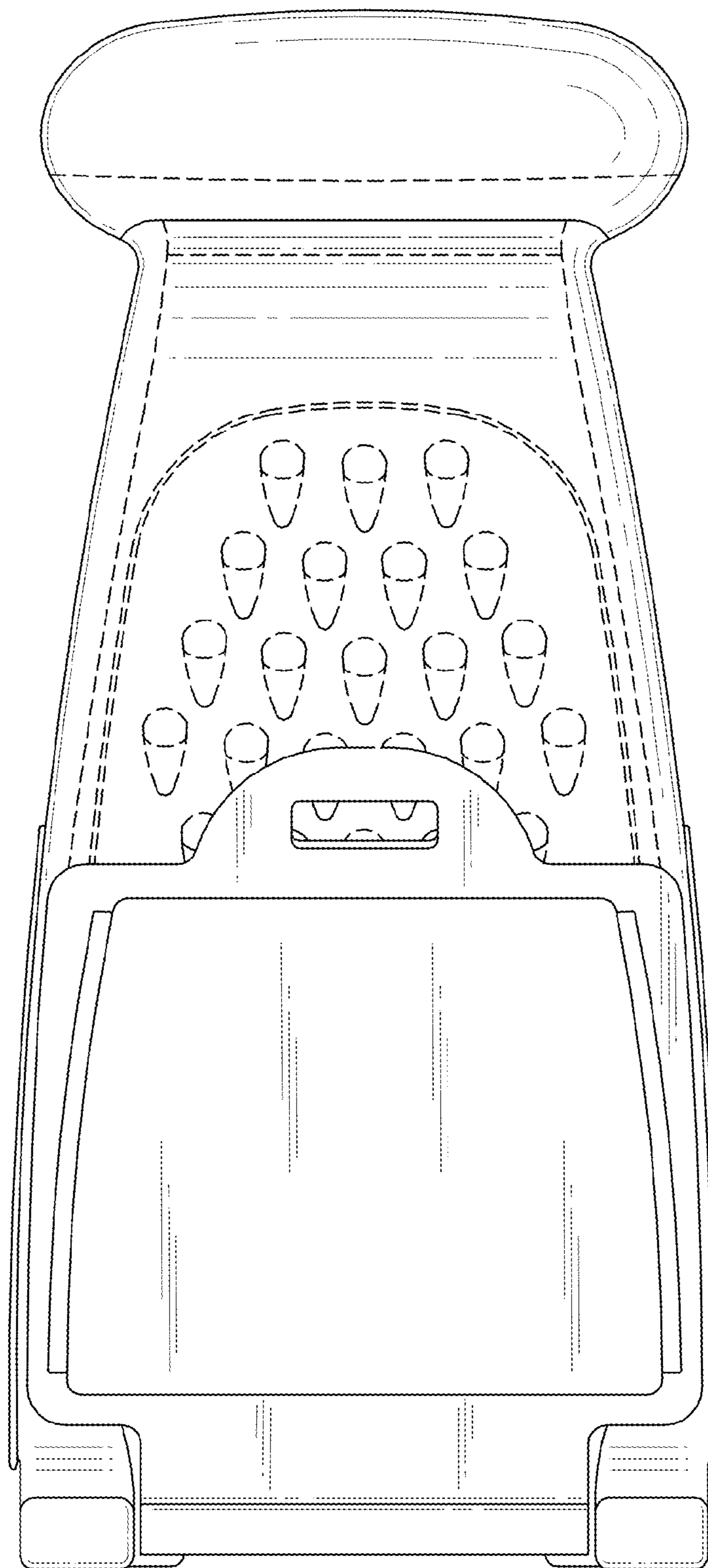
The broken lines in the drawings represent unclaimed features.

**1 Claim, 13 Drawing Sheets**





**FIG. 1**



**FIG. 2**



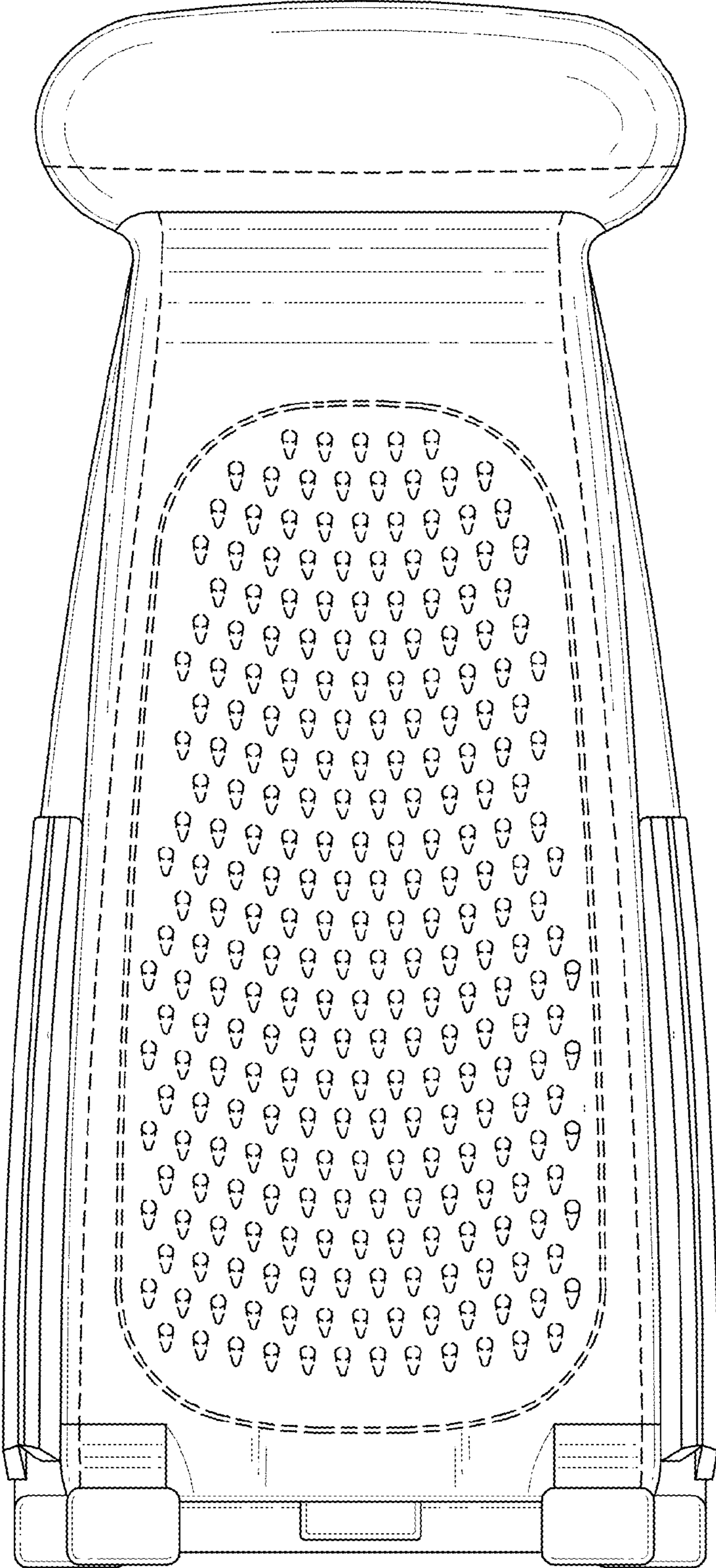
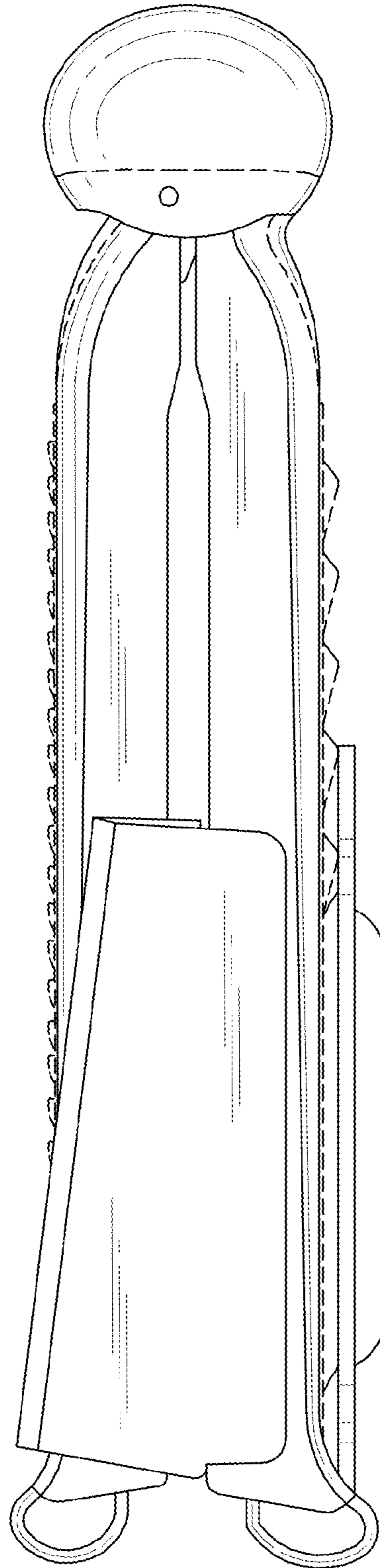
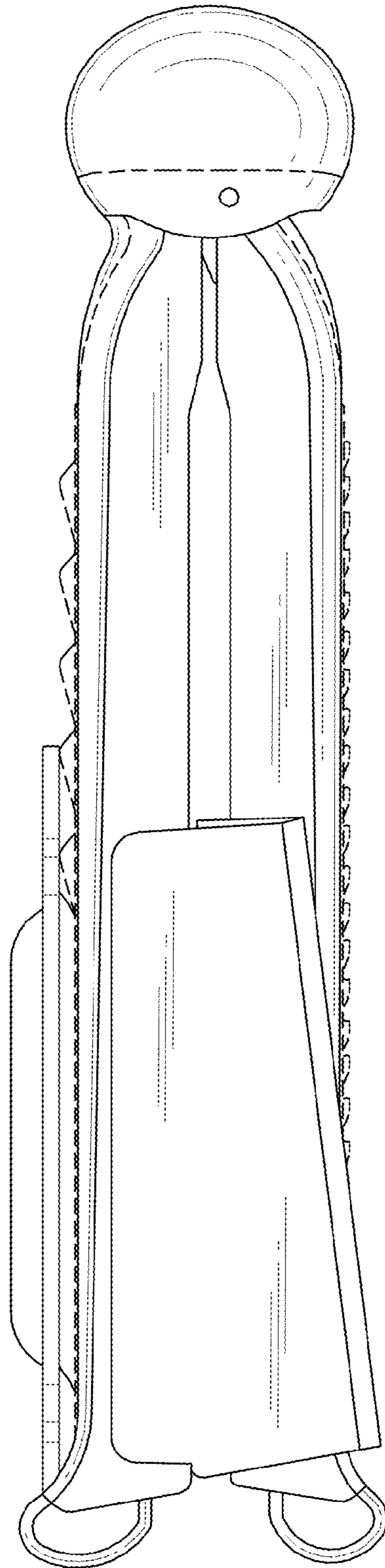


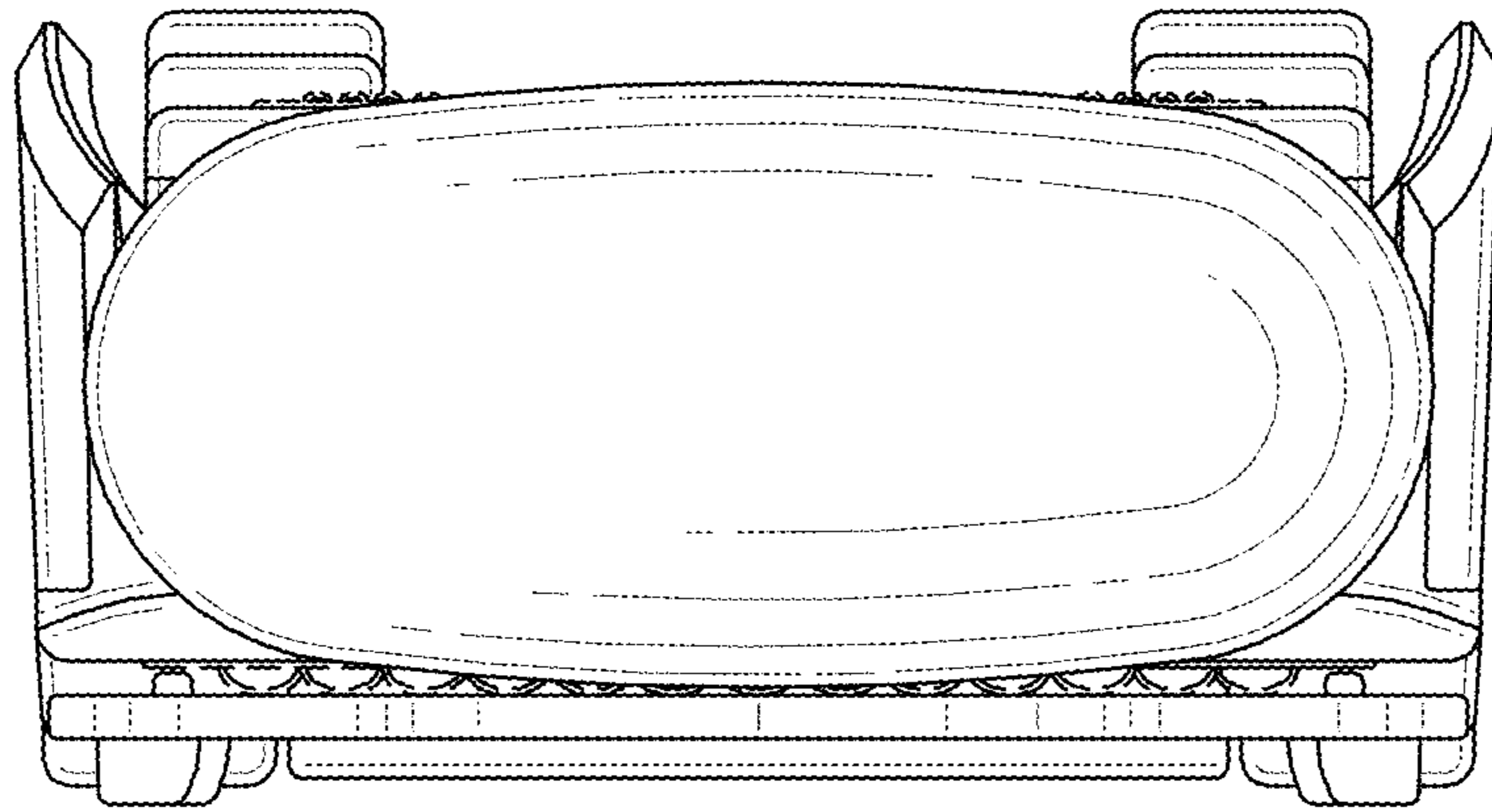
FIG. 3



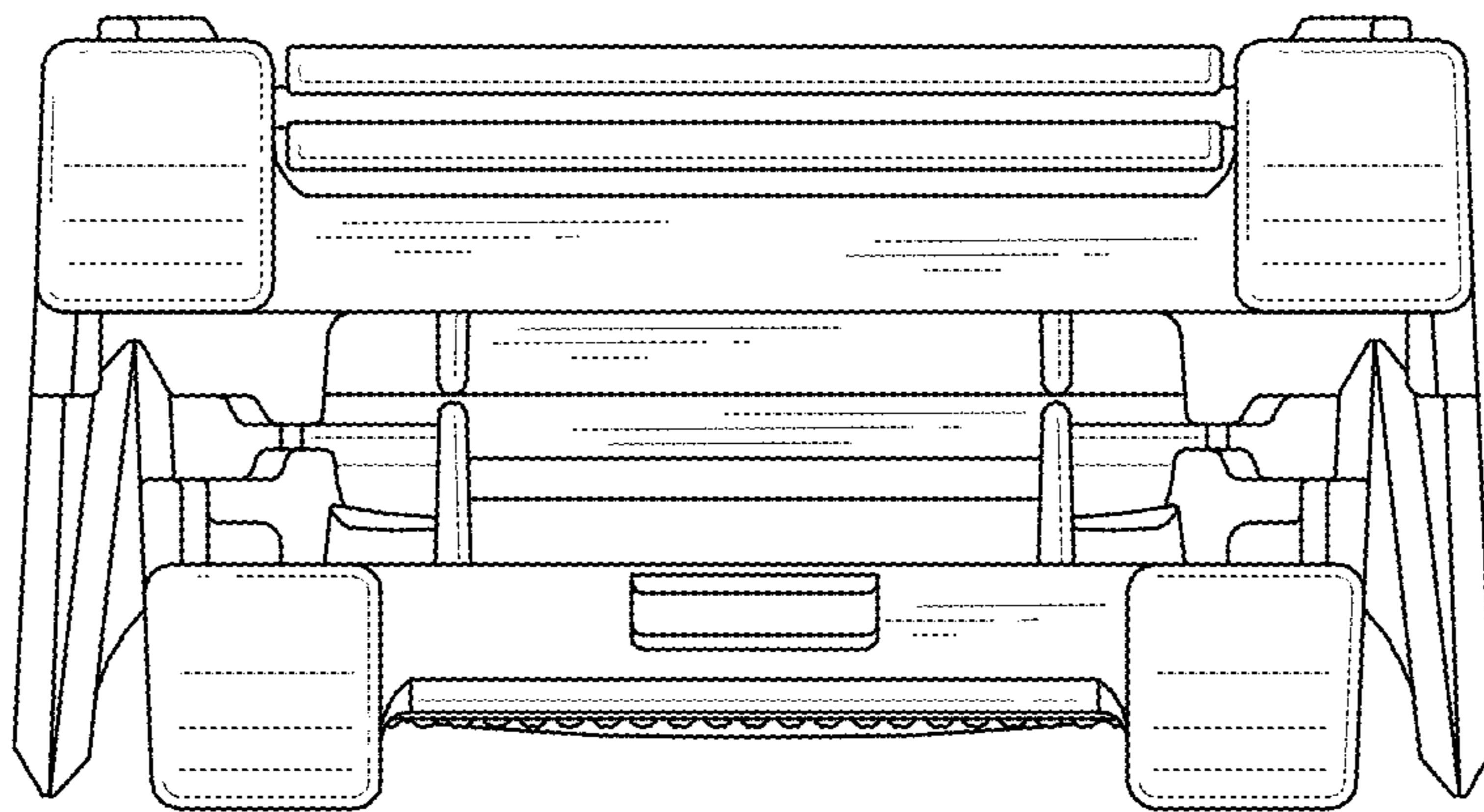
**FIG. 4**



**FIG. 5**



*FIG. 6*



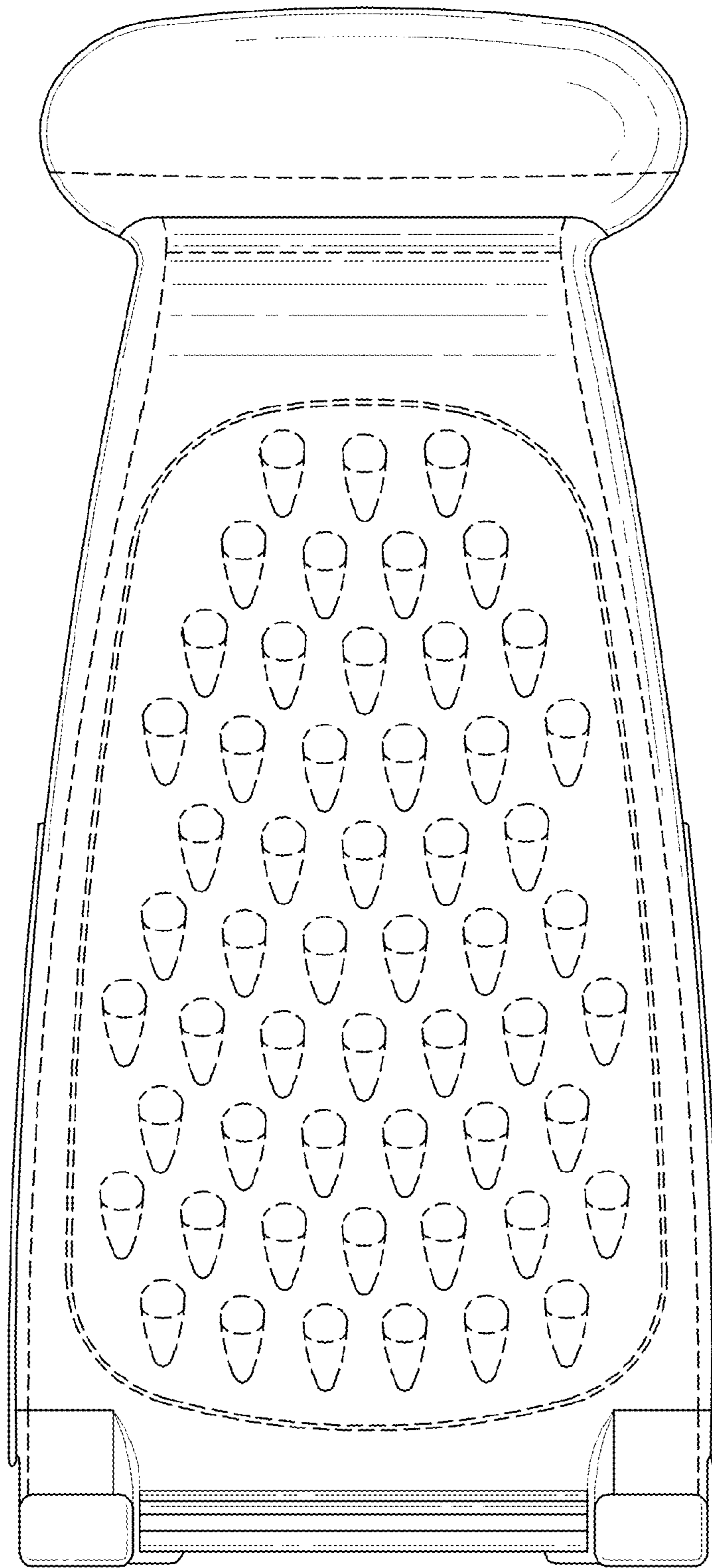
*FIG. 7*



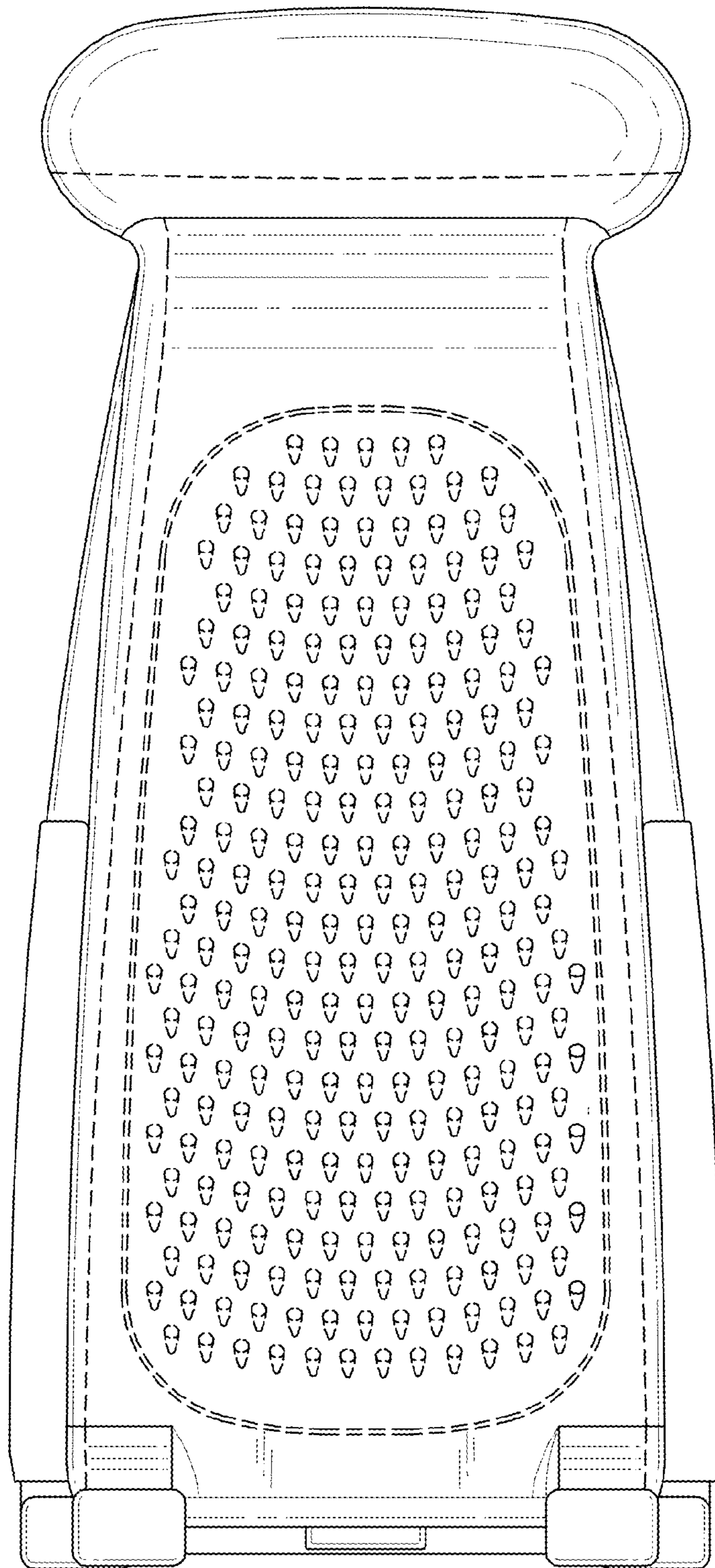


**FIG. 8**

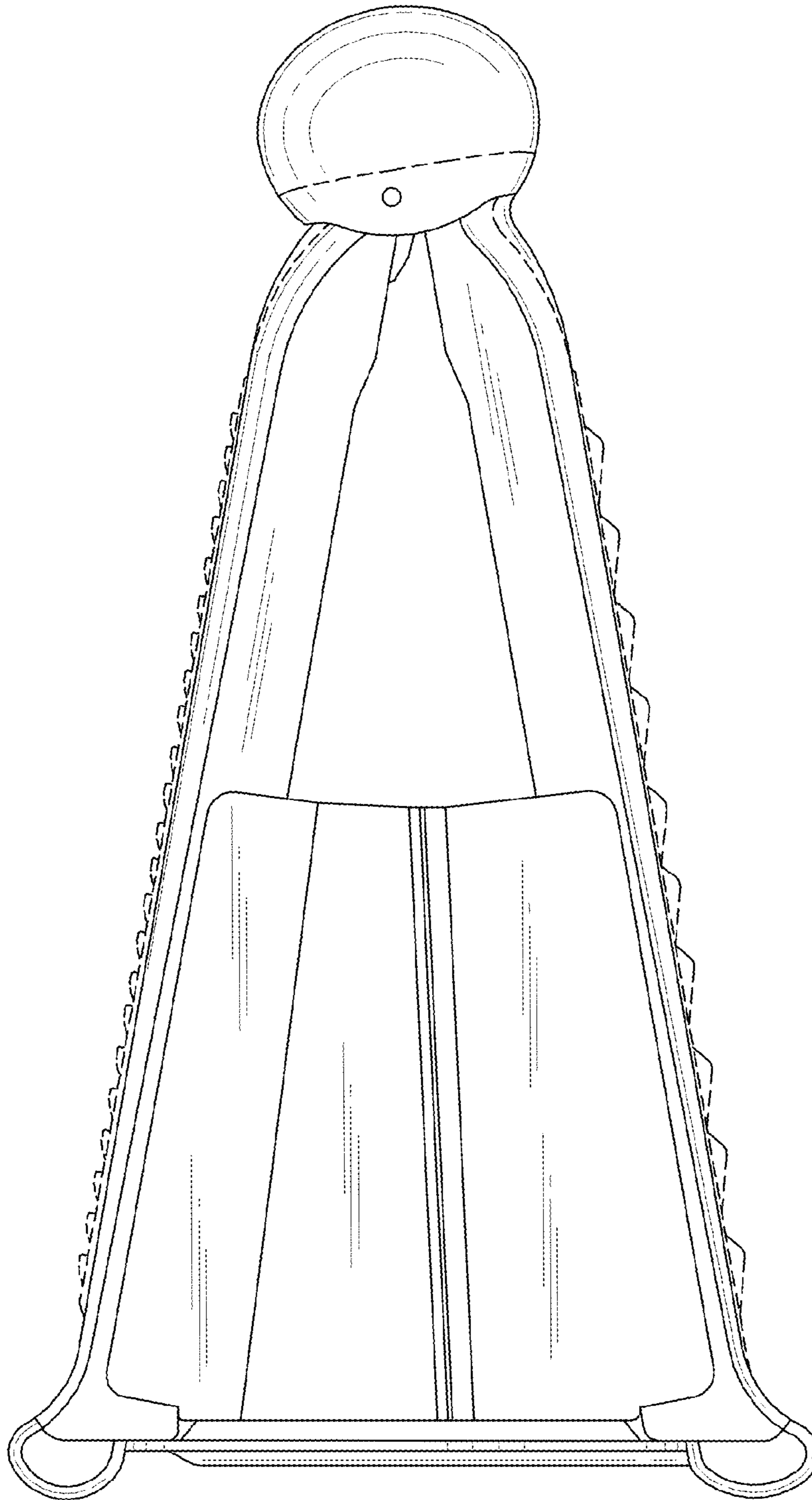




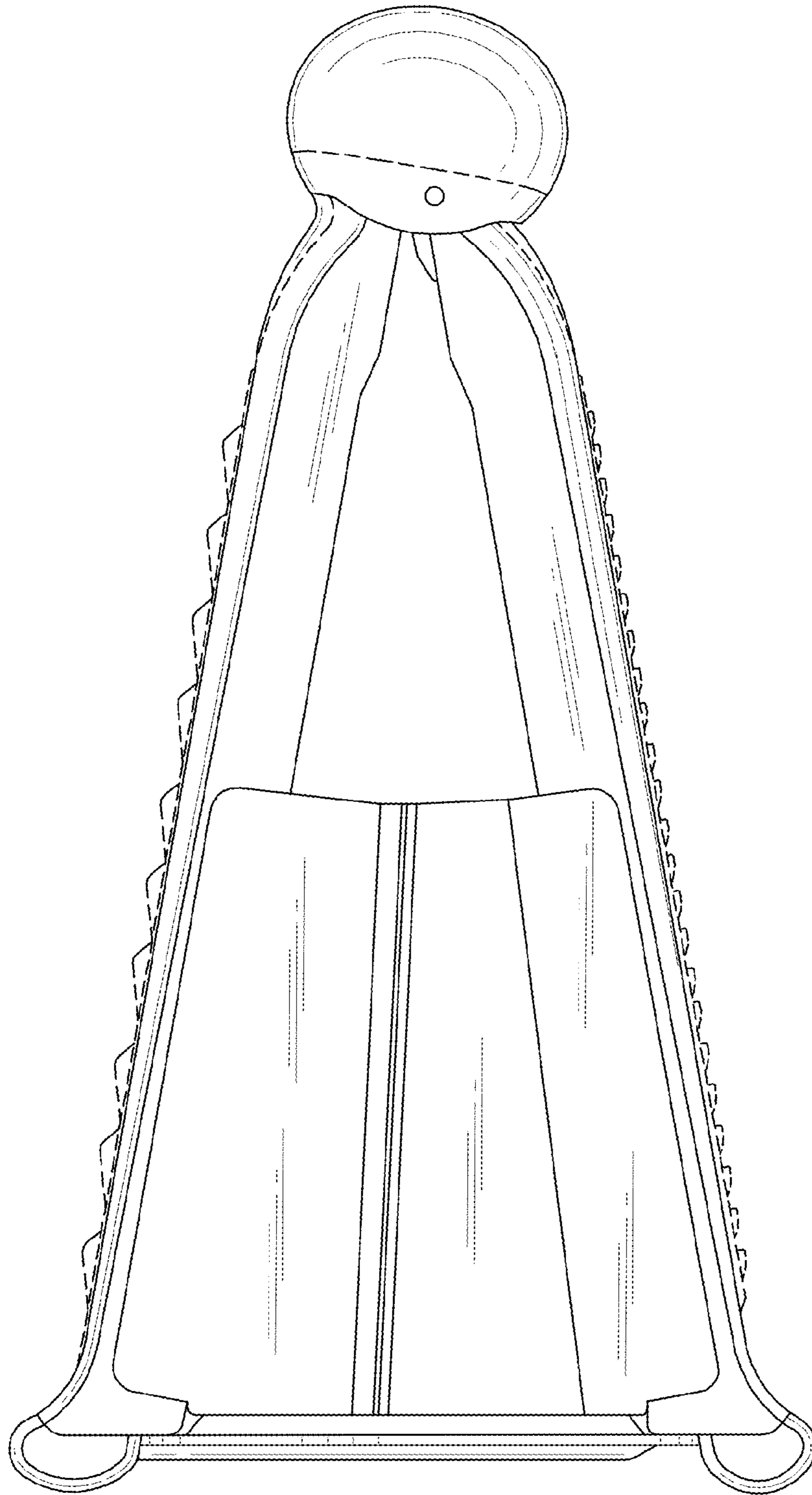
**FIG. 9**



**FIG. 10**

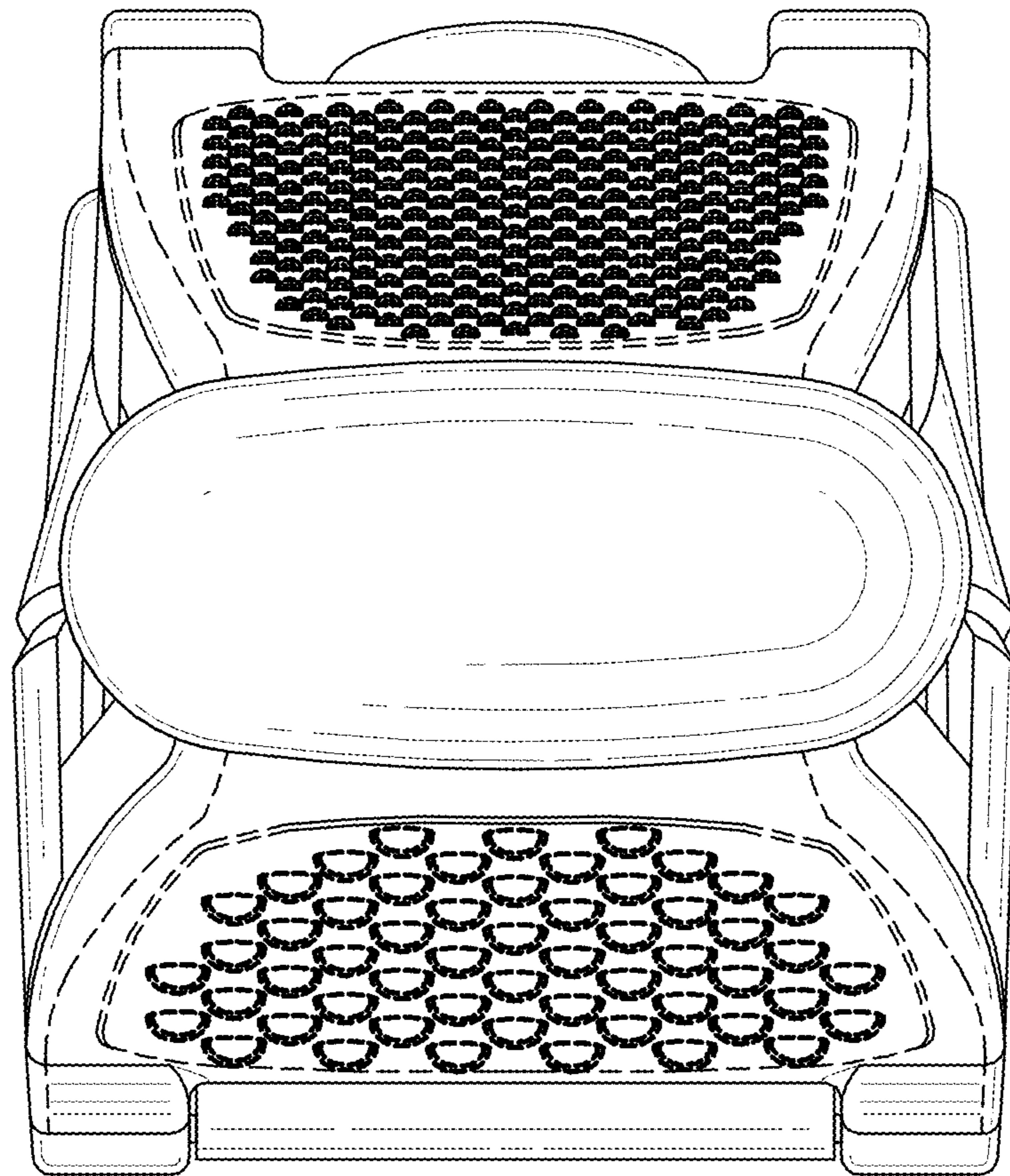


**FIG. 11**

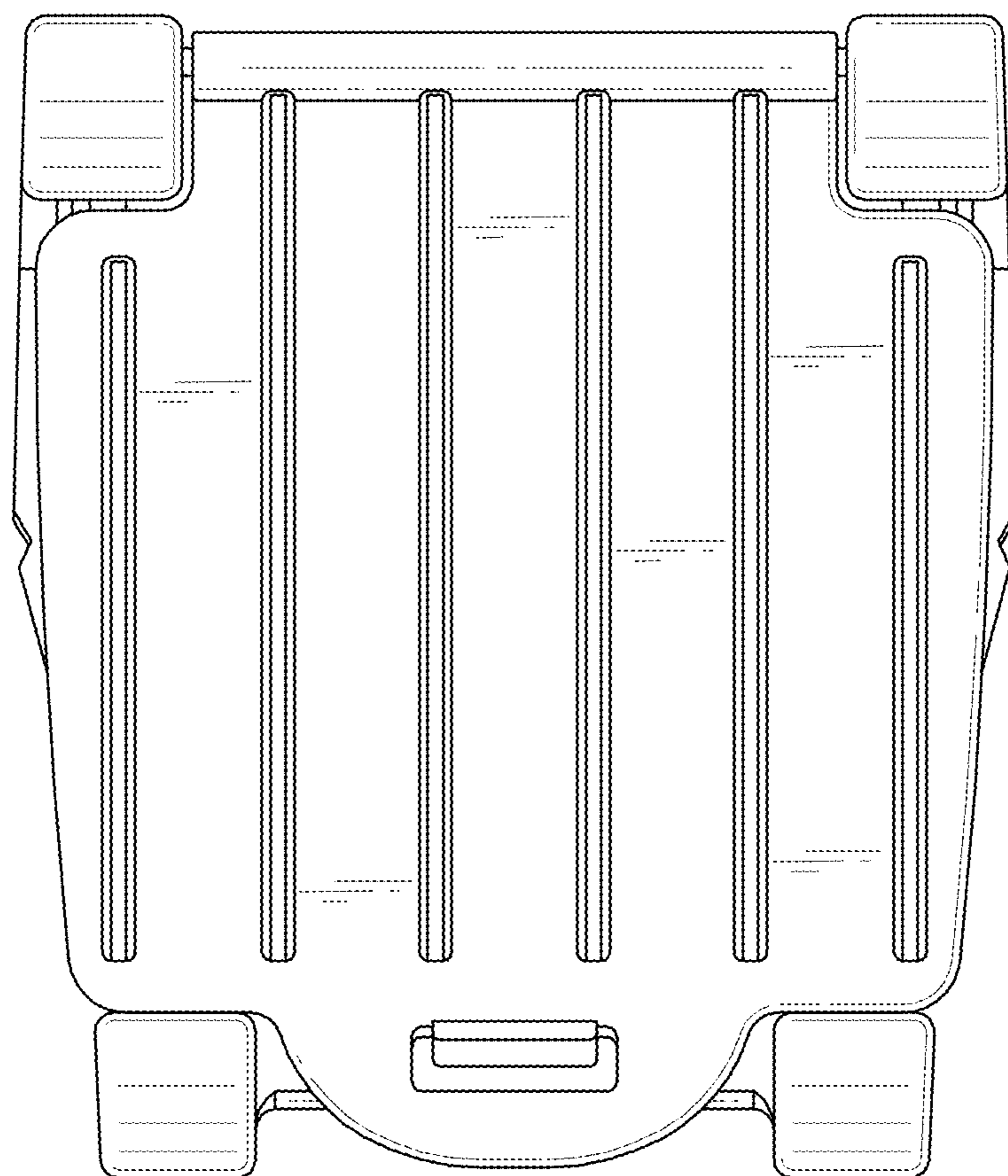


**FIG. 12**





*FIG. 13*



*FIG. 14*