

US00D695519S

(12) **United States Design Patent**
Khubani

(10) **Patent No.:** **US D695,519 S**
(45) **Date of Patent:** **** Dec. 17, 2013**

- (54) **WALLET CASE**
- (71) Applicant: **Poonam Khubani**, Saddle River, NJ (US)
- (72) Inventor: **Poonam Khubani**, Saddle River, NJ (US)
- (73) Assignee: **Telebrands Corp.**, Fairfield, NJ (US)
- (**) Term: **14 Years**
- (21) Appl. No.: **29/441,172**
- (22) Filed: **Jan. 2, 2013**

D413,017 S	8/1999	Masoud	
D425,699 S	5/2000	Lau	
D429,562 S	8/2000	Lau	
D439,042 S	3/2001	Lau	
D443,414 S *	6/2001	Schimmel D3/250
D510,187 S	10/2005	Chan	
D547,547 S	7/2007	Maurion	
D565,298 S	4/2008	Braun	
D565,842 S	4/2008	Falcone	
D577,910 S	10/2008	Hollinger	
D592,398 S	5/2009	Roesler	
D612,152 S	3/2010	Roesler	
D666,811 S	9/2012	Yang	
D672,952 S	12/2012	Yang	
2006/0151077 A1	7/2006	Milford	
2012/0261042 A1	10/2012	Khubani	

- (51) **LOC (9) Cl.** **03-01**
- (52) **U.S. Cl.**
USPC **D3/247; D3/240**
- (58) **Field of Classification Search**
USPC D3/232–233, 240–243, 245–247,
D3/249–253; 150/100, 103–110, 113–114,
150/117–119, 130, 132, 136–137, 147
See application file for complete search history.

(56) **References Cited**

U.S. PATENT DOCUMENTS

1,986,057 A	1/1935	Hackworth	
2,000,538 A *	5/1935	Resnick 150/105
2,327,532 A *	8/1943	Krupp 150/110
2,435,870 A *	2/1948	Campos 150/104
2,527,339 A	10/1950	Tamoschat	
2,658,543 A *	11/1953	Budnick 150/118
2,836,288 A	5/1958	Atchison	
3,024,899 A	3/1962	Reitzel	
4,027,710 A *	6/1977	Keebler 150/103
D283,950 S	5/1986	Markowitz	
4,974,652 A	12/1990	Lemler	
D319,345 S	8/1991	Rayburn	
5,125,531 A	6/1992	Wentz	
D344,182 S	2/1994	Guzman-Rosario	
5,560,476 A	10/1996	Lee	
D376,257 S	12/1996	Broussalian	

OTHER PUBLICATIONS

Office Action mailed May 23, 2012 in U.S. Appl. No. 29/389,683 (application filed Apr. 14, 2011; inventor: Ajit Khubani).
 “Calling-card-case”; www.chairaddict.com; 2010.
 “VF 19th C. Tortoise Shell Fan-FoldCard Case”; www.rubylane.com; 2010.
 “M.363 Antique Silver Card Case”, www.dandantiques.com; 2010.

(Continued)

Primary Examiner — Holly Baynham
 (74) *Attorney, Agent, or Firm* — Cooper & Dunham LLP

(57) **CLAIM**

The ornamental design for a wallet case, as shown and described.

DESCRIPTION

FIG. 1 is a bottom perspective view thereof;
 FIG. 2 is a bottom view thereof;
 FIG. 3 is a top view thereof;
 FIG. 4 is a front side view thereof;
 FIG. 5 is a rear side view thereof;
 FIG. 6 is a left side view thereof; and,
 FIG. 7 is a right side view thereof.

1 Claim, 5 Drawing Sheets

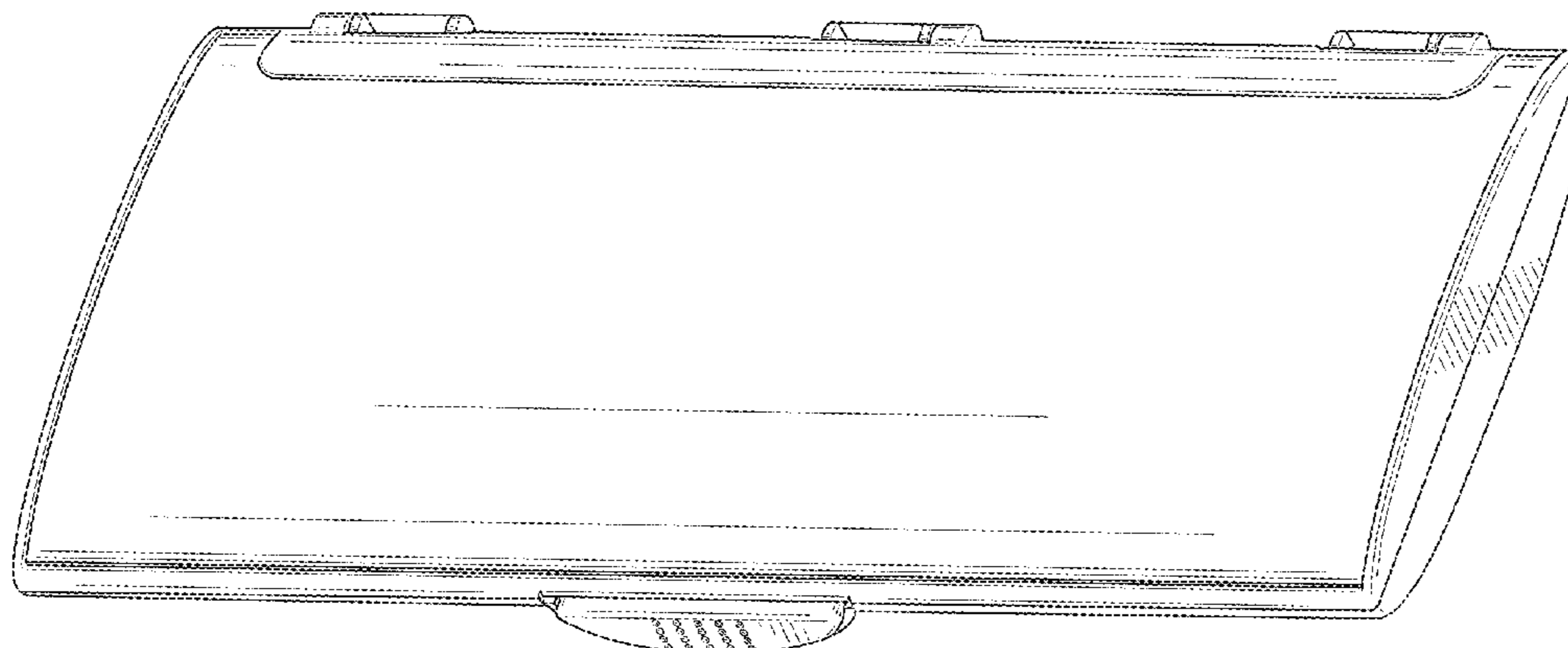

(56)

References Cited

OTHER PUBLICATIONS

“Magnificent Antique Ivory Card Case, Victorian & with Sterling Silver Pencil”; www.rubylane.com; 2010.

“Antique Mother of Pearl Calling Card Case”; www.rubylane.com; 2010.

“Ogon RFID Wallet—Gadget of the Day” Aiza Mababayag; www.gadgetsandtechnologynews.com/ogon-rfid-wallet-gadget-of-the-dat/282283/ (dated May 26, 2010) as accessed Mar. 13, 2012.

Various pages and images from the domain www.ogondesigns.com (copyright 2011) as accessed Mar. 23, 2012.

* cited by examiner

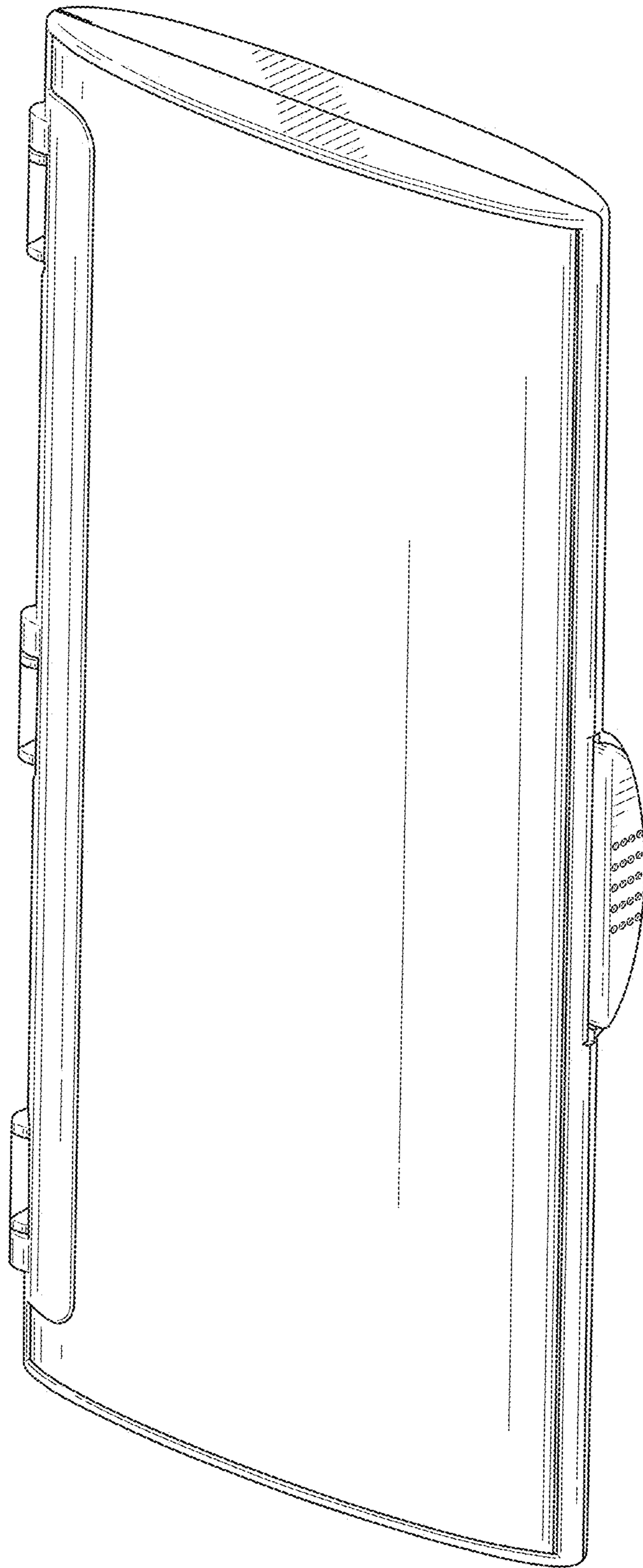

FIG. 1

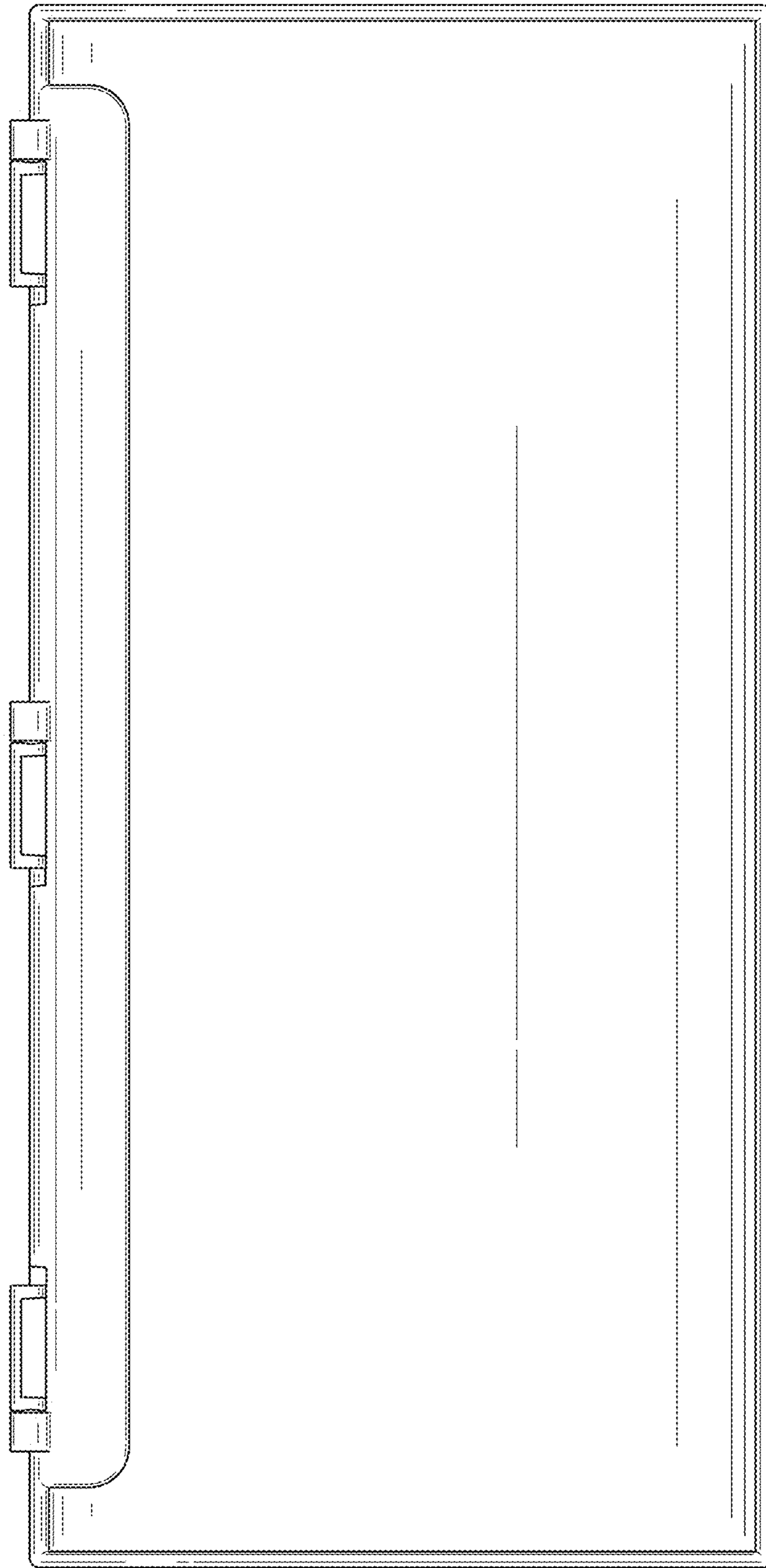

FIG. 2

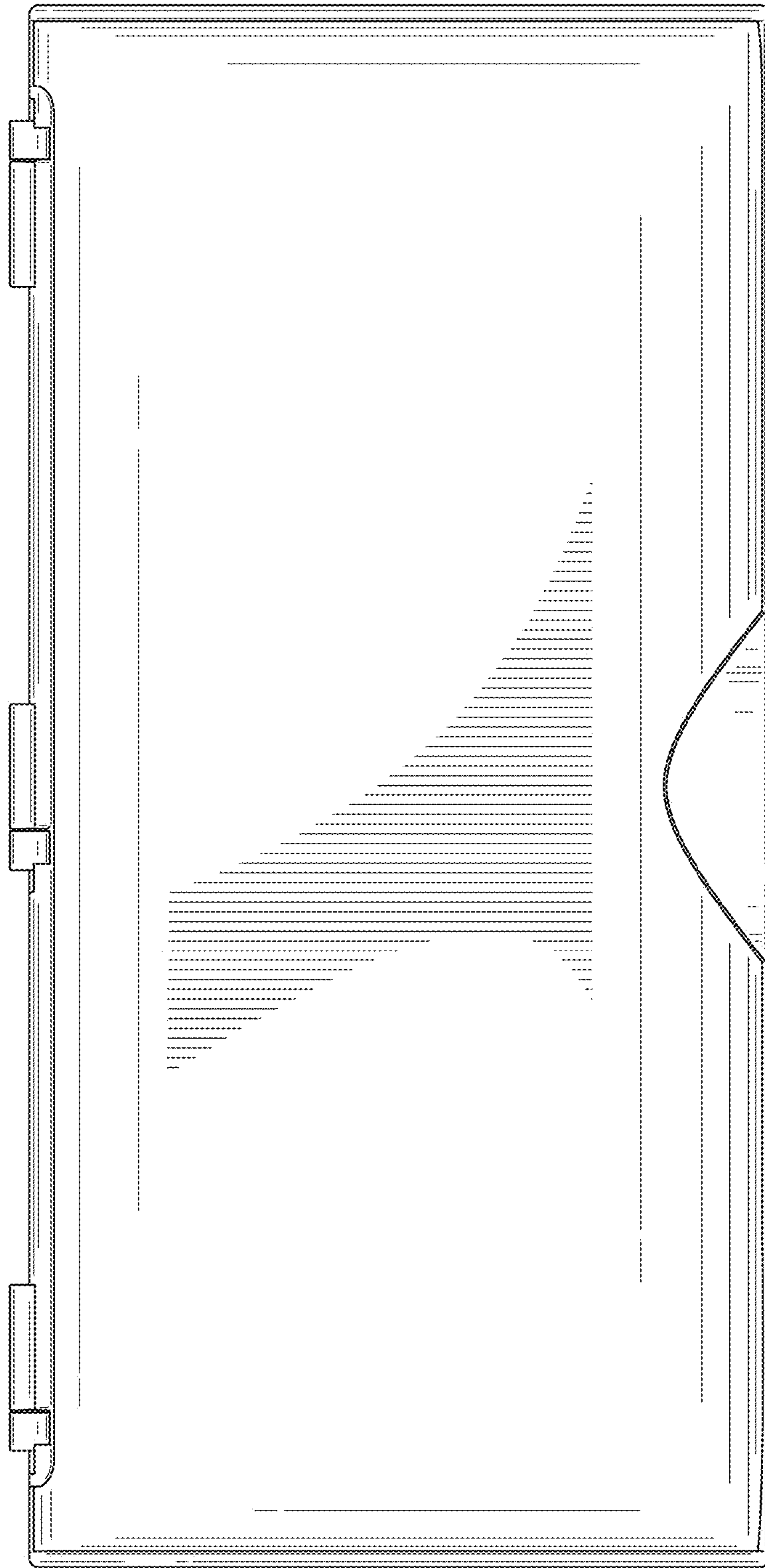

FIG. 3

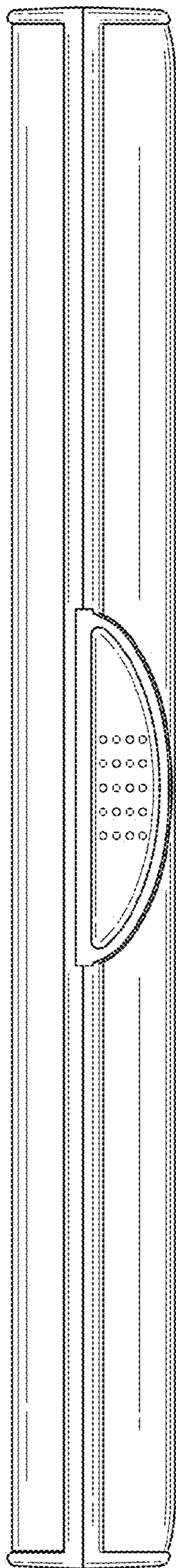

FIG. 4

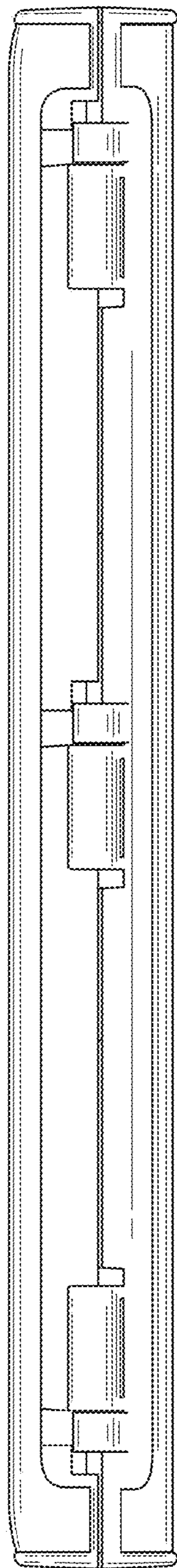

FIG. 5

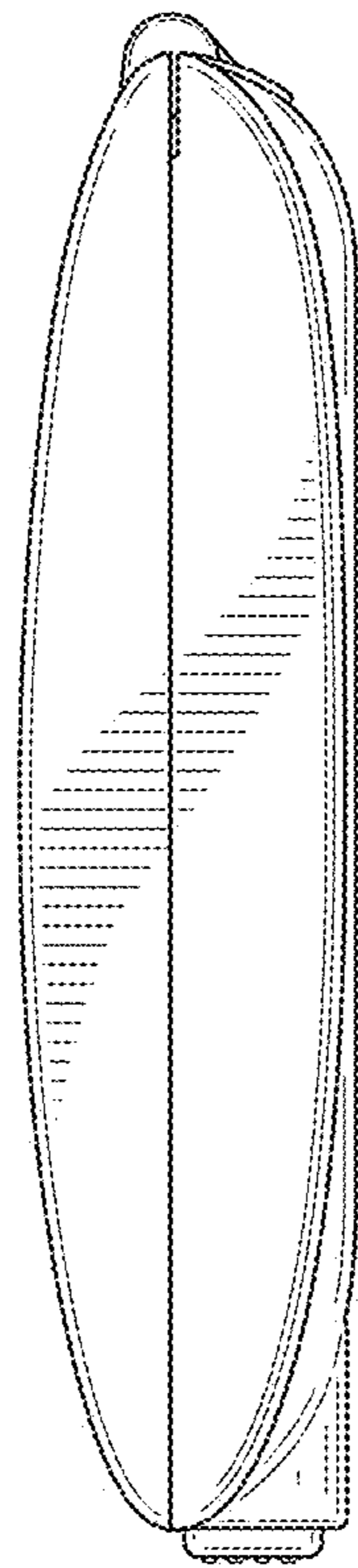

FIG. 6

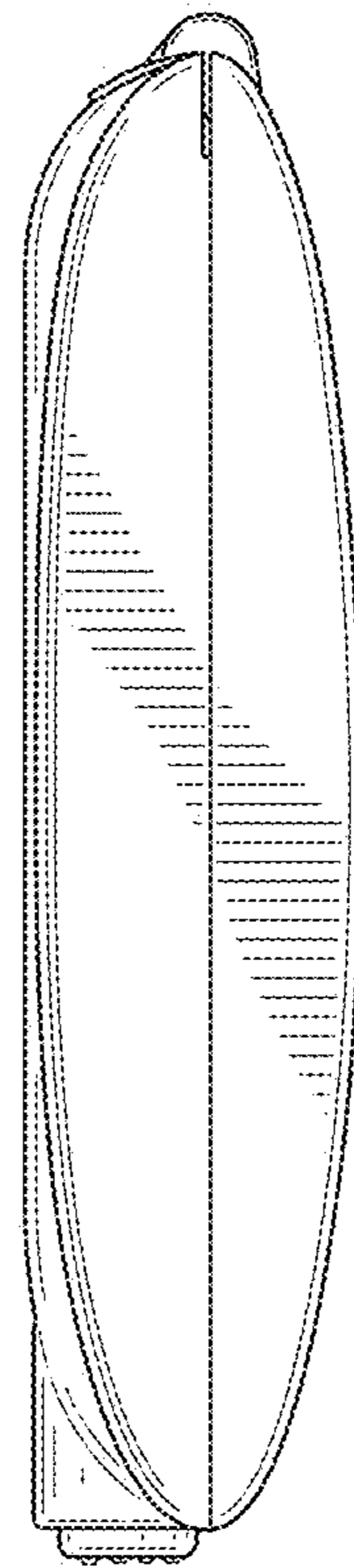

FIG. 7