



US00D695472S

(12) **United States Design Patent**
Börjesson

(10) **Patent No.:** **US D695,472 S**

(45) **Date of Patent:** **** Dec. 10, 2013**

(54) **LAUNDRY APPLIANCE**

(71) Applicant: **Electrolux Home Products Corporation N.V., Brussels (BE)**

(72) Inventor: **Per Börjesson, Porcia (IT)**

(73) Assignee: **Electrolux Home Products Corporation N.V. (BE)**

(**) Term: **14 Years**

(21) Appl. No.: **29/434,333**

(22) Filed: **Oct. 11, 2012**

(30) **Foreign Application Priority Data**

Apr. 11, 2012 (EM) 002023317

(51) **LOC (9) Cl.** **15-05**

(52) **U.S. Cl.**
USPC **D32/6**

(58) **Field of Classification Search**
USPC D32/1, 3, 5-10, 25, 28; 34/3 R, 4, 5 R,
34/12.01, 12.07, 212; 68/87-88, 523-524
See application file for complete search history.

(56) **References Cited**

U.S. PATENT DOCUMENTS

D191,918 S * 12/1961 Stern D32/8
D477,898 S * 7/2003 Geyer D32/6
D495,453 S * 8/2004 Baldwin et al. D32/8

D502,577 S * 3/2005 Baldwin et al. D32/6
D563,062 S * 2/2008 Eicher et al. D32/6
D565,809 S * 4/2008 Eicher et al. D32/6
D575,463 S * 8/2008 Mao et al. D32/6
D613,009 S * 3/2010 DeSalvo et al. D32/6
D617,512 S * 6/2010 DeSalvo et al. D32/25
D618,866 S * 6/2010 Lee D32/6
7,934,399 B2 * 5/2011 No et al. 68/3 R
D640,020 S * 6/2011 Helot et al. D32/5
D653,822 S * 2/2012 Geyer et al. D32/6
D659,307 S * 5/2012 Geyer et al. D32/6

* cited by examiner

Primary Examiner — T. Chase Nelson
Assistant Examiner — Kathleen M Sims

(74) *Attorney, Agent, or Firm* — Banner & Witcoff, Ltd.

(57) **CLAIM**

The ornamental design for a laundry appliance, as shown and described.

DESCRIPTION

FIG. 1 is a front perspective view of a laundry appliance showing my new design;
FIG. 2 is a front view thereof;
FIG. 3 is a rear view thereof;
FIG. 4 is a top view thereof;
FIG. 5 is a bottom view thereof;
FIG. 6 is a right side view thereof; and,
FIG. 7 is a left side view thereof.

The broken line showing of the remainder of the laundry appliance is for environmental purposes only and forms no part of the claimed design.

1 Claim, 7 Drawing Sheets

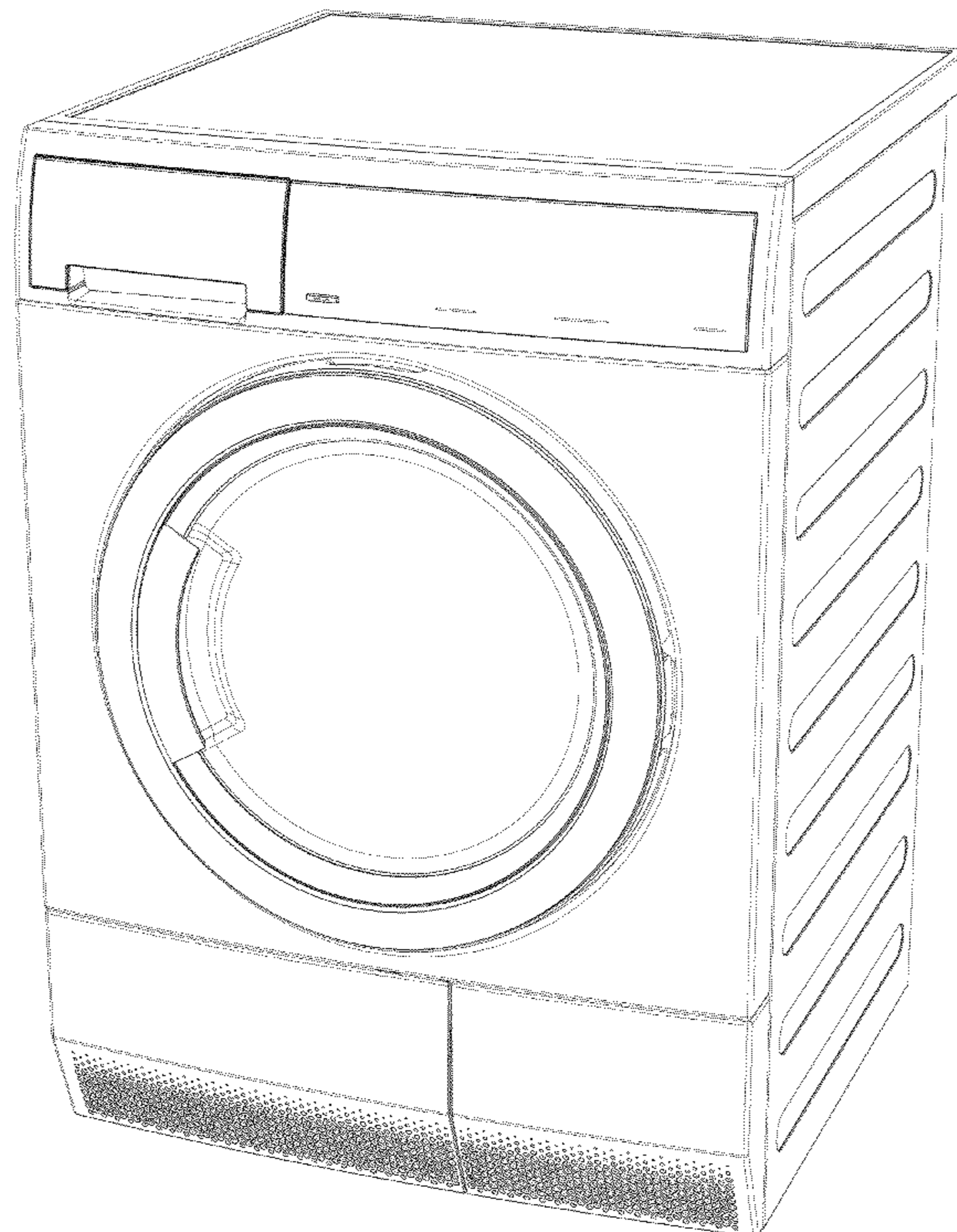

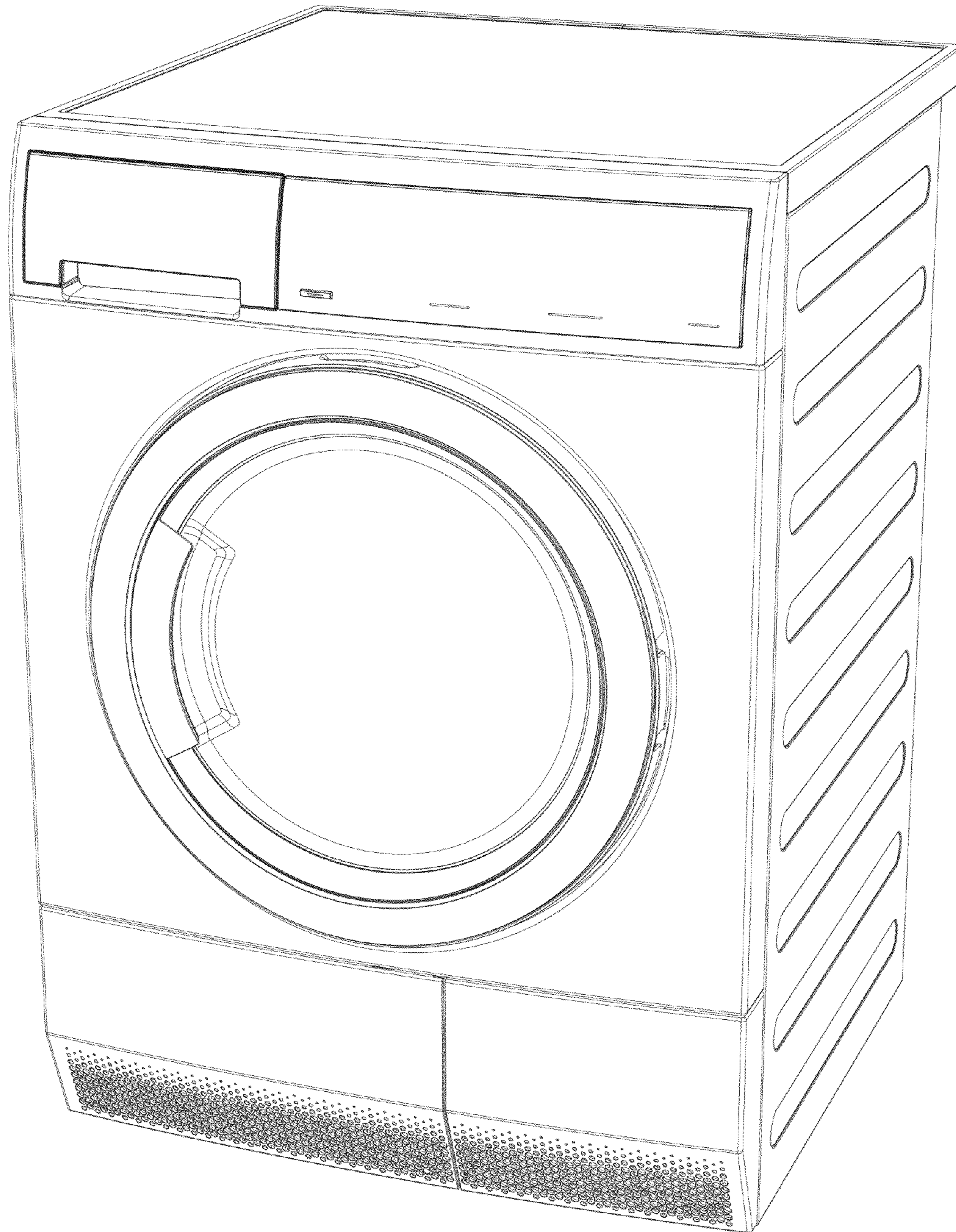

FIG. 1

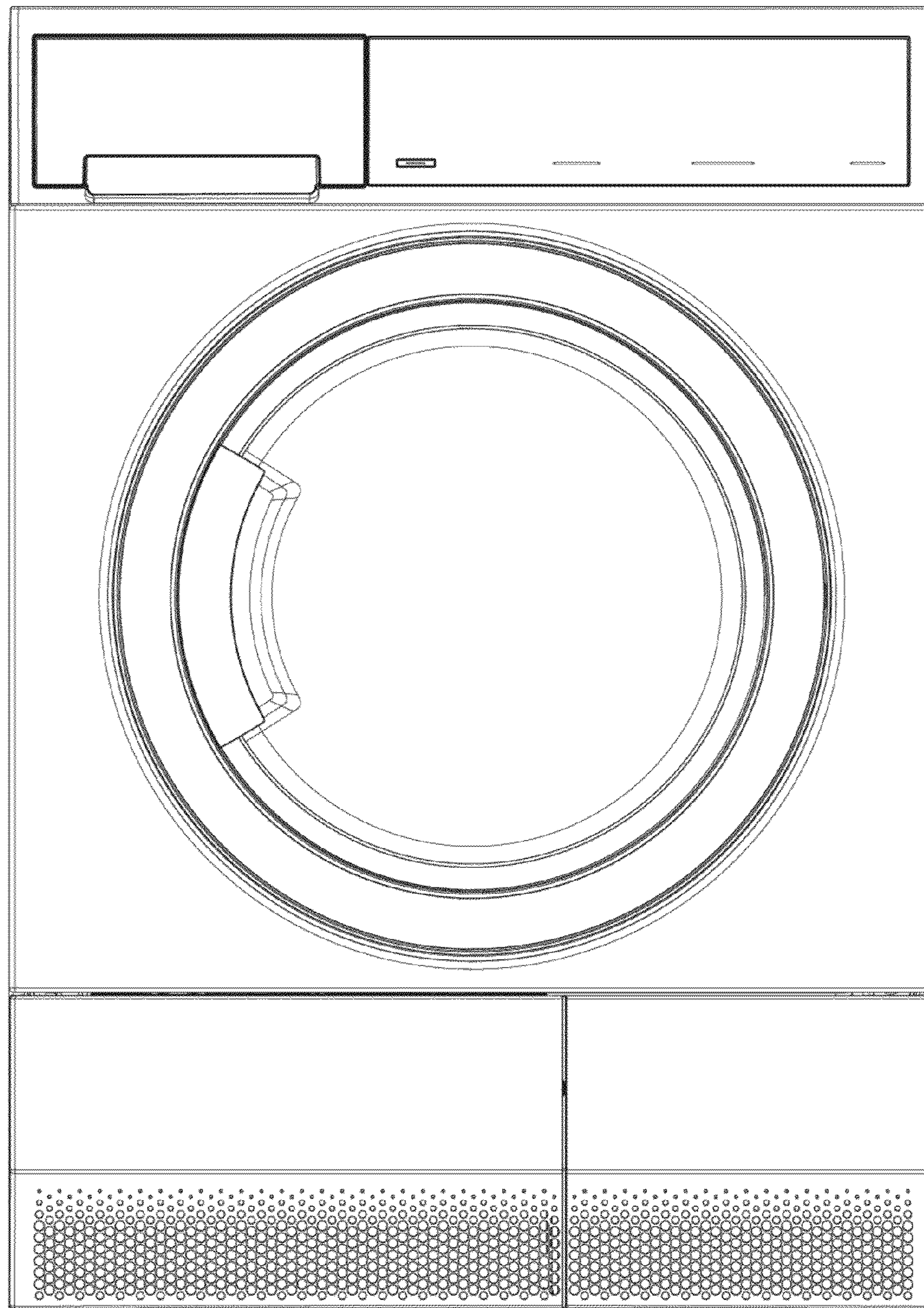

FIG. 2

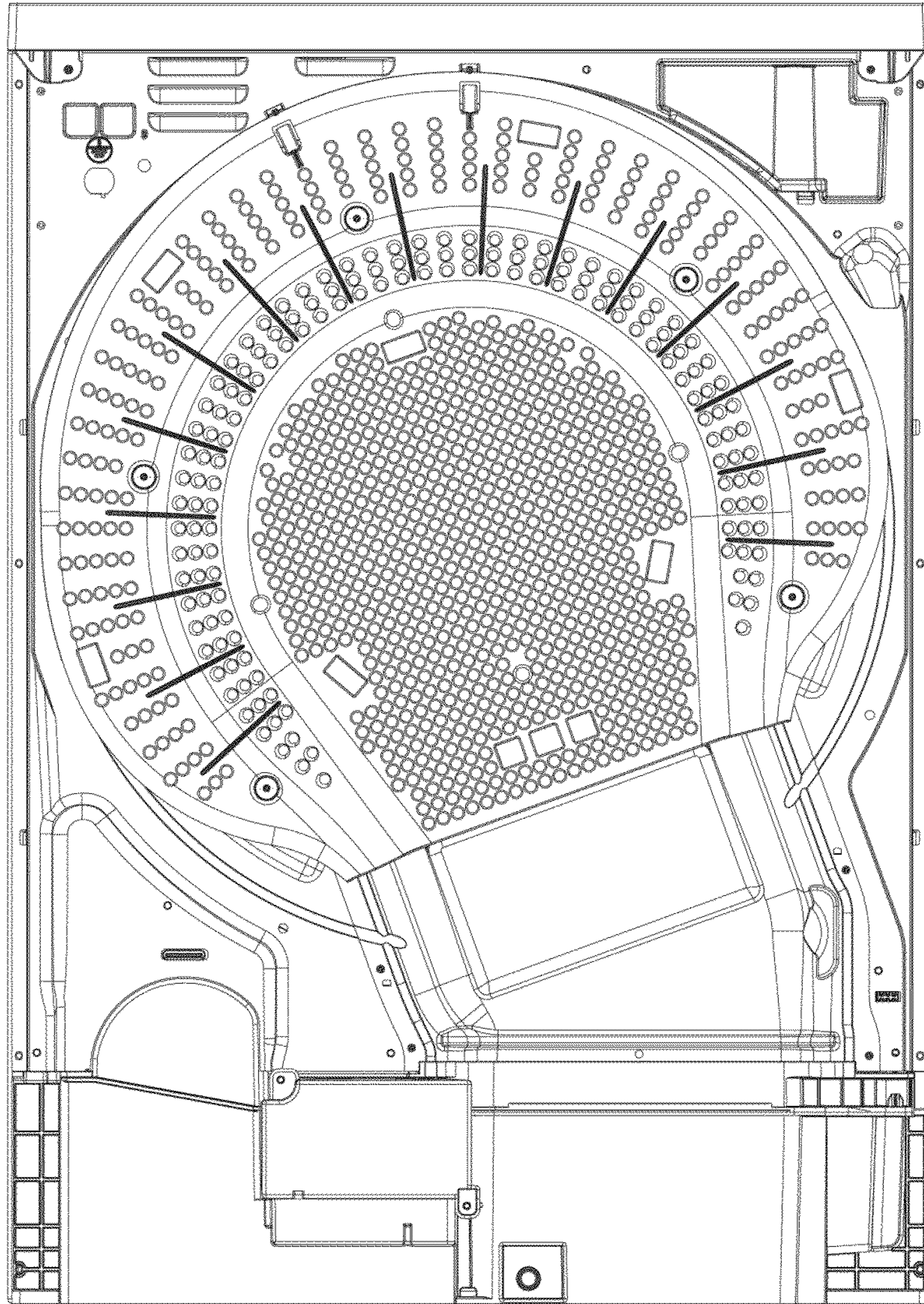

FIG. 3

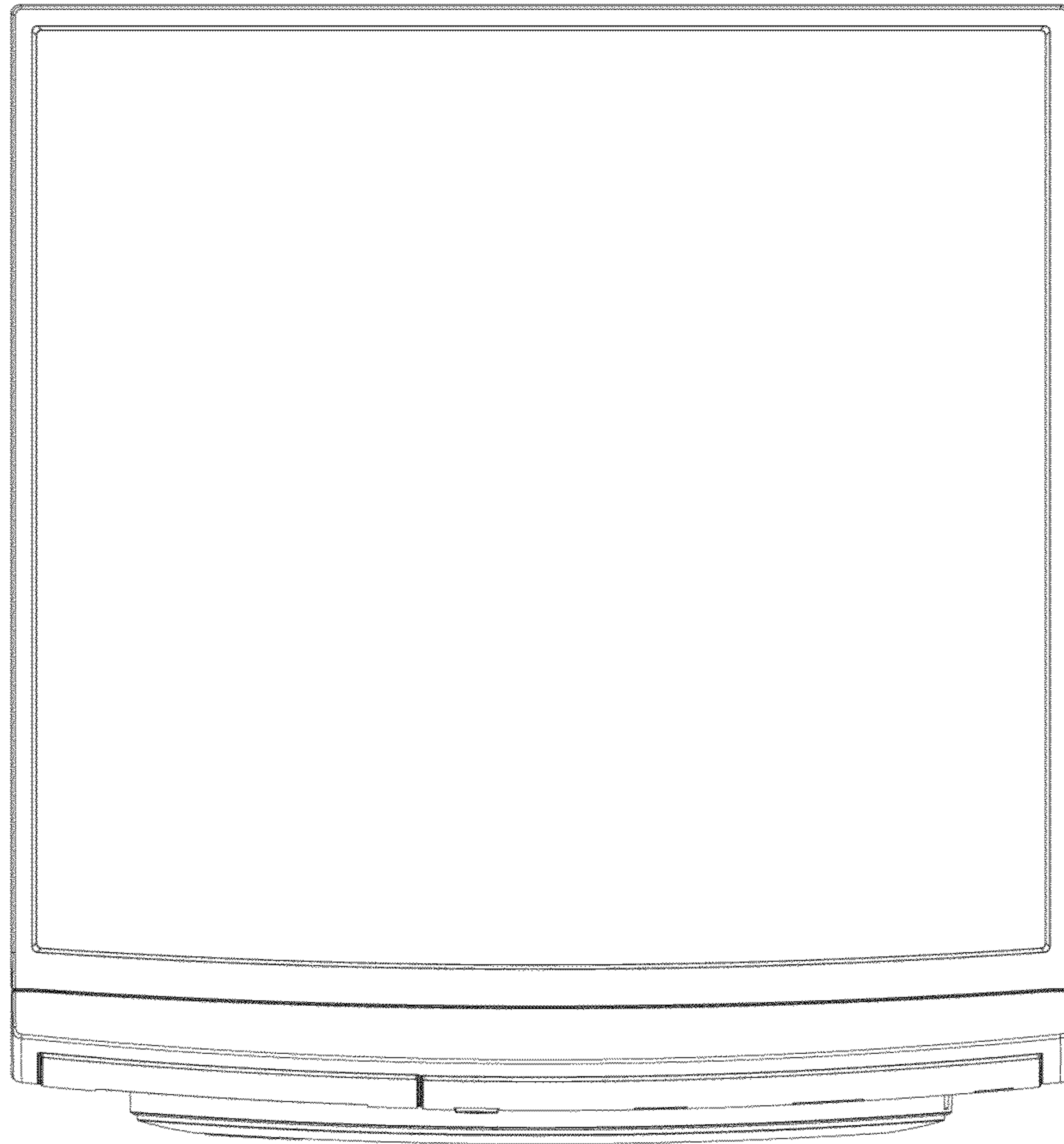

FIG. 4

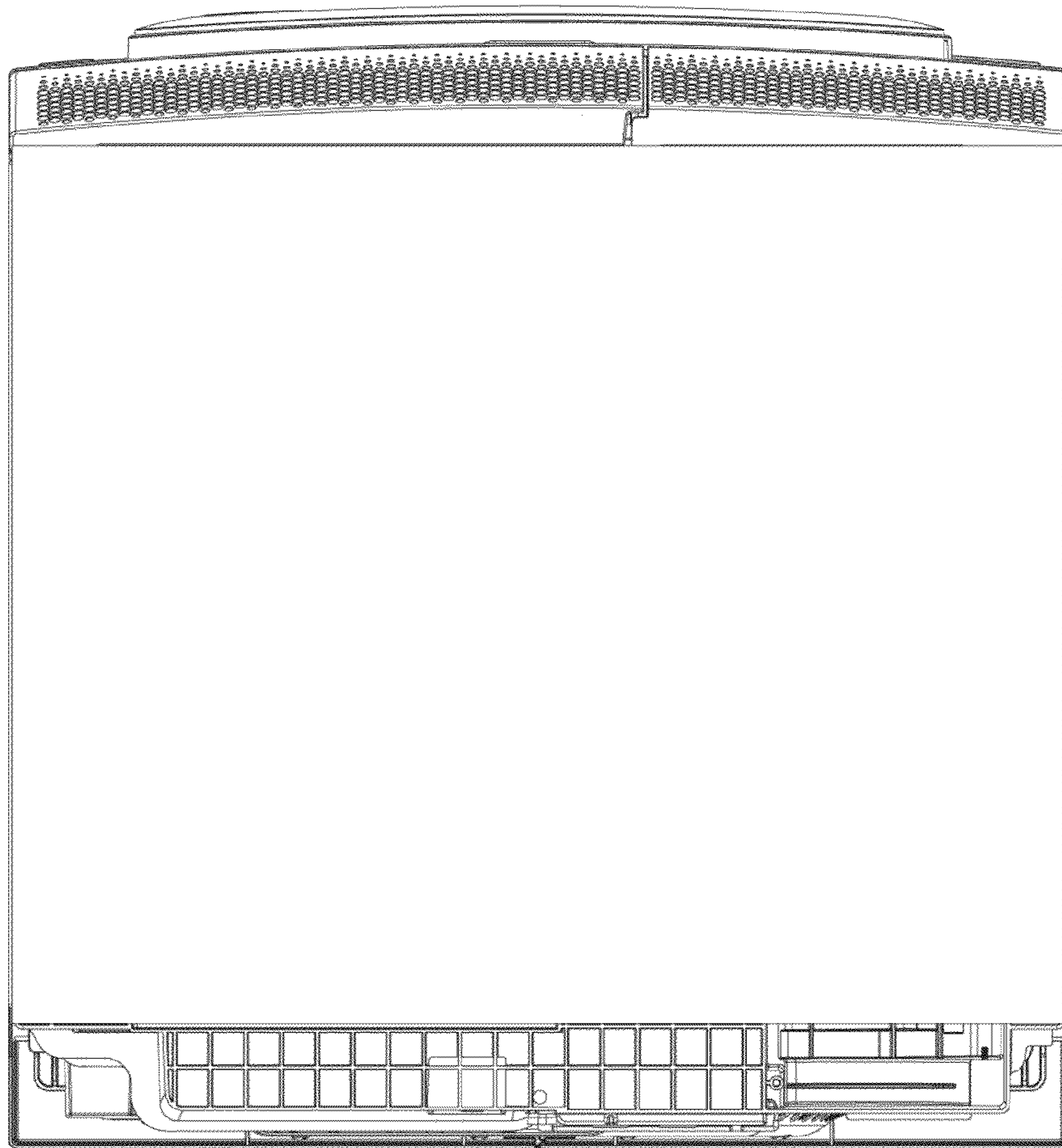

FIG. 5

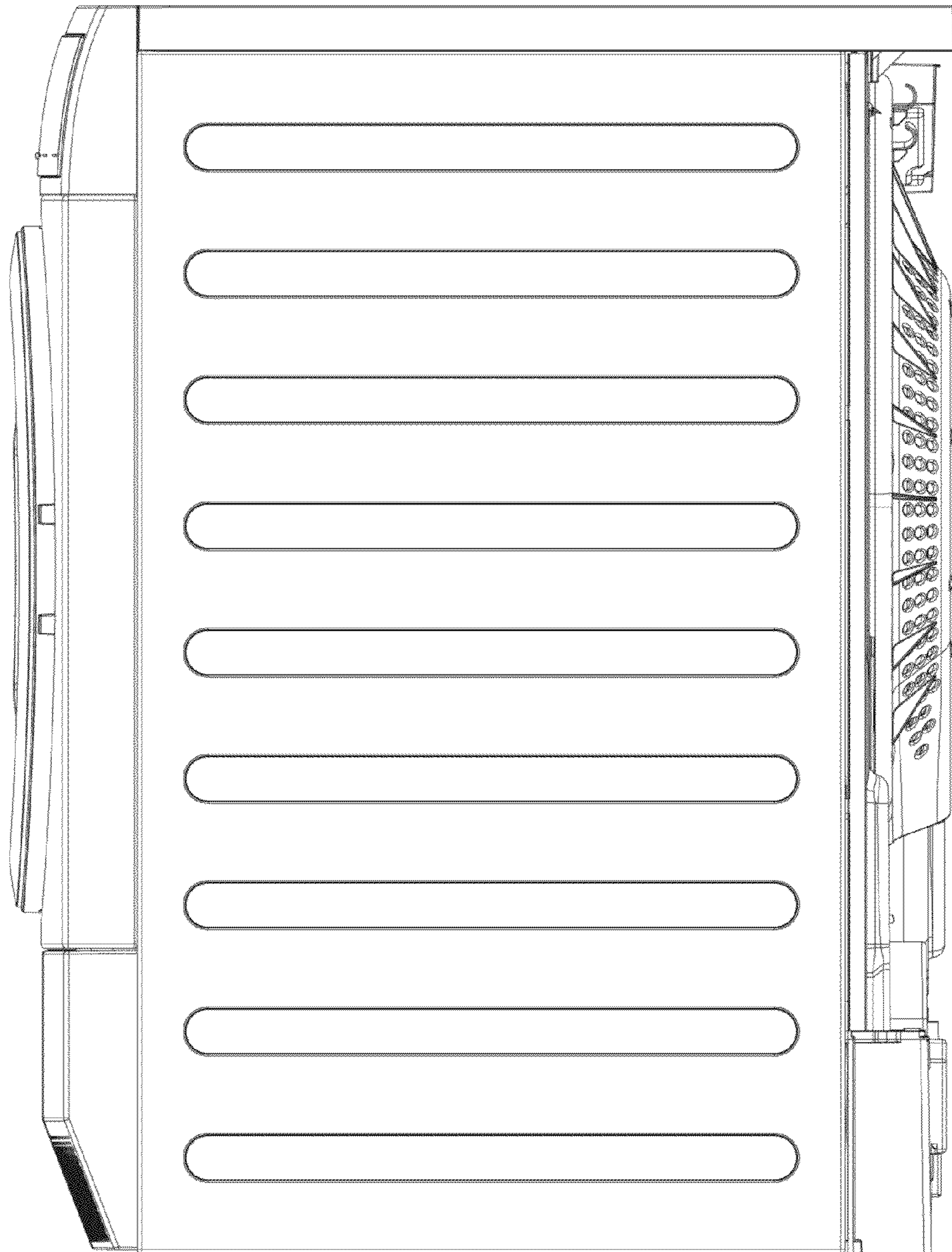

FIG. 6

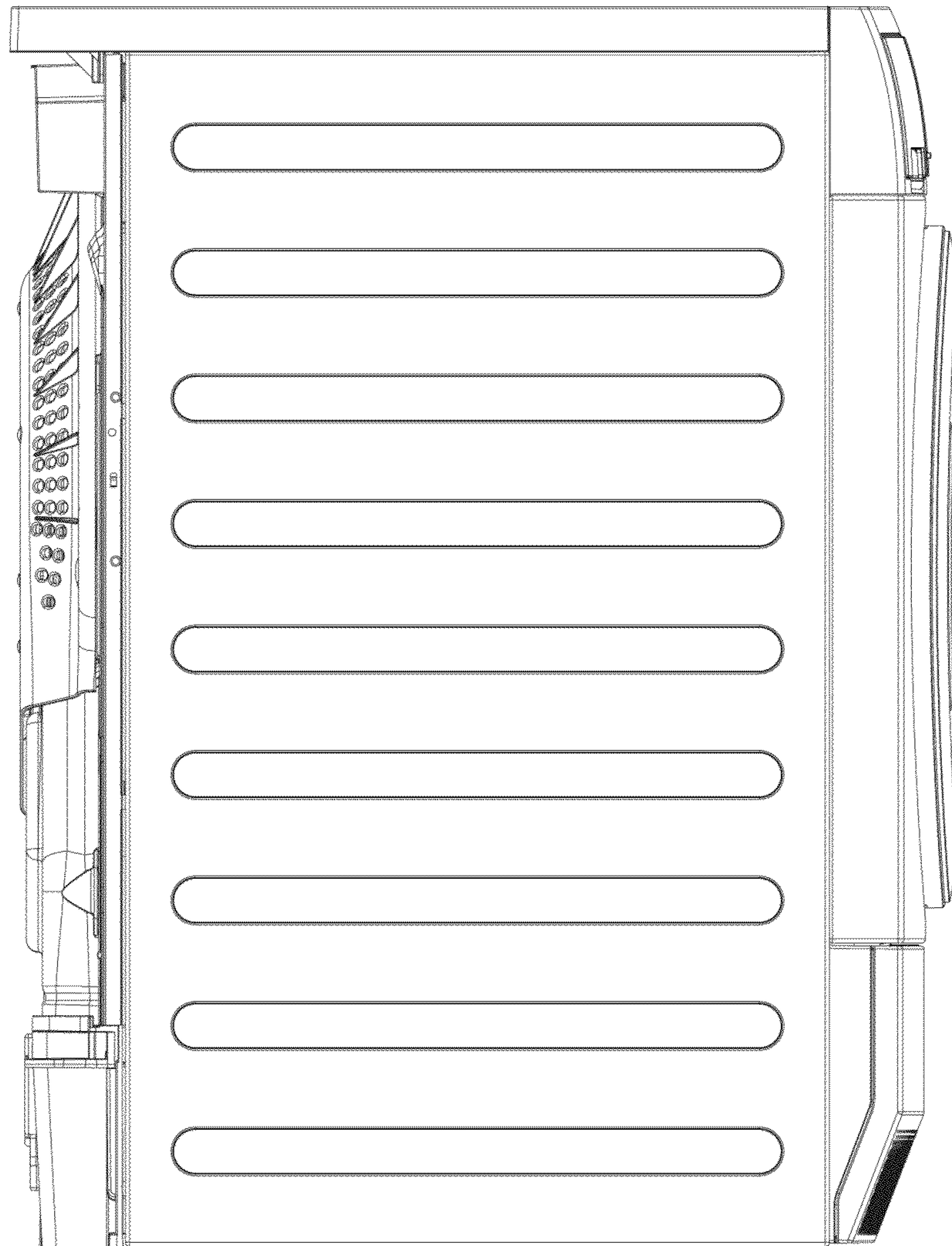

FIG. 7