

US00D695372S

(12) **United States Design Patent**
Button et al.

(10) **Patent No.:** **US D695,372 S**
(45) **Date of Patent:** **** Dec. 10, 2013**

(54) **CORK GRIP FOR GOLF PUTTERS**

(71) Applicant: **MW Outfitters, LLC**, Richmond, VA (US)

(72) Inventors: **Mark Button**, Richmond, VA (US);
Whitfield Flowers, Tampa, FL (US)

(73) Assignee: **MW Outfitters, LLC**, Richmond, VA (US)

(**) Term: **14 Years**

(21) Appl. No.: **29/439,257**

(22) Filed: **Dec. 7, 2012**

(51) **LOC (9) Cl.** **21-02**

(52) **U.S. Cl.**
USPC **D21/756**

(58) **Field of Classification Search**
USPC D21/756-758; 473/300-303, 200-204
See application file for complete search history.

(56) **References Cited**

U.S. PATENT DOCUMENTS

1,587,082 A	6/1926	Mattern	
3,173,689 A	3/1965	Serblin	
3,606,326 A *	9/1971	Sparks et al.	473/300
3,782,725 A	1/1974	Giambazi	
3,837,647 A	9/1974	Jacques	
D265,576 S	7/1982	Lamkin et al.	
4,746,120 A *	5/1988	Mockovak	473/201
D314,600 S	2/1991	Tosti	
D319,278 S	8/1991	Tosti	
D355,011 S	1/1995	Subnick	
5,427,376 A	6/1995	Cummings et al.	
D361,110 S	8/1995	Koeneman et al.	
D375,340 S *	11/1996	Stryczek	D21/756

(Continued)

OTHER PUBLICATIONS

http://corkygolf.com/Corky_Grips.html.

Primary Examiner — Mitchell Siegel

(74) *Attorney, Agent, or Firm* — Goodman, Allen & Filetti, PLLC; Matthew R. Osenga

(57) **CLAIM**

The ornamental design for a cork grip for golf putters, as shown and described.

DESCRIPTION

FIG. 1 is an isometric view of a first embodiment of the invention.

FIG. 2 is a front view of a first embodiment of the invention.

FIG. 3 is a rear view of a first embodiment of the invention.

FIG. 4 is a left view of a first embodiment of the invention.

FIG. 5 is a right view of a first embodiment of the invention.

FIG. 6 is a bottom view of a first embodiment of the invention.

FIG. 7 is a top view of a first embodiment of the invention.

FIG. 8 is an isometric view of a second embodiment of the invention.

FIG. 9 is a front view of a second embodiment of the invention.

FIG. 10 is a rear view of a second embodiment of the invention.

FIG. 11 is a left view of a second embodiment of the invention.

FIG. 12 is a right view of a second embodiment of the invention.

FIG. 13 is a bottom view of a second embodiment of the invention; and,

FIG. 14 is a top view of a second embodiment of the invention.

The broken lines showing the shaft, as seen in FIGS. 1 and 8, form no part of the claimed design.

1 Claim, 6 Drawing Sheets

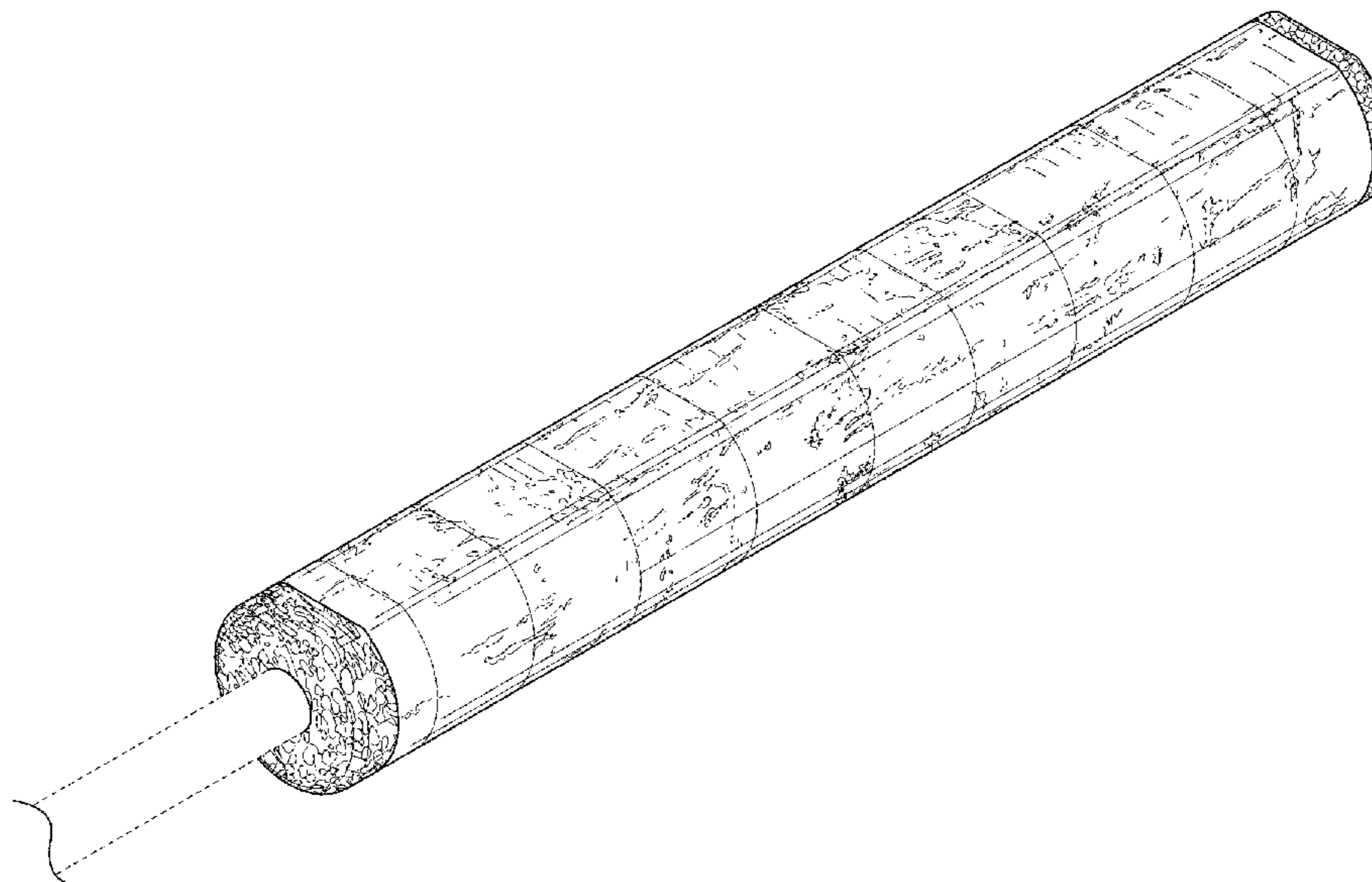

(56)

References Cited

U.S. PATENT DOCUMENTS

D383,821 S * 9/1997 Wood D21/756
D416,597 S 11/1999 Grove et al.
6,226,836 B1 5/2001 Yasui
6,666,777 B1 12/2003 Lamkin et al.

6,988,958 B2 * 1/2006 Roelke 473/295
D629,480 S 12/2010 Garsen
D641,443 S 7/2011 Watson
D654,973 S 2/2012 Marshall
D658,247 S 4/2012 Button
8,272,973 B2 * 9/2012 Lu 473/300
D676,910 S * 2/2013 Button et al. D21/756

* cited by examiner

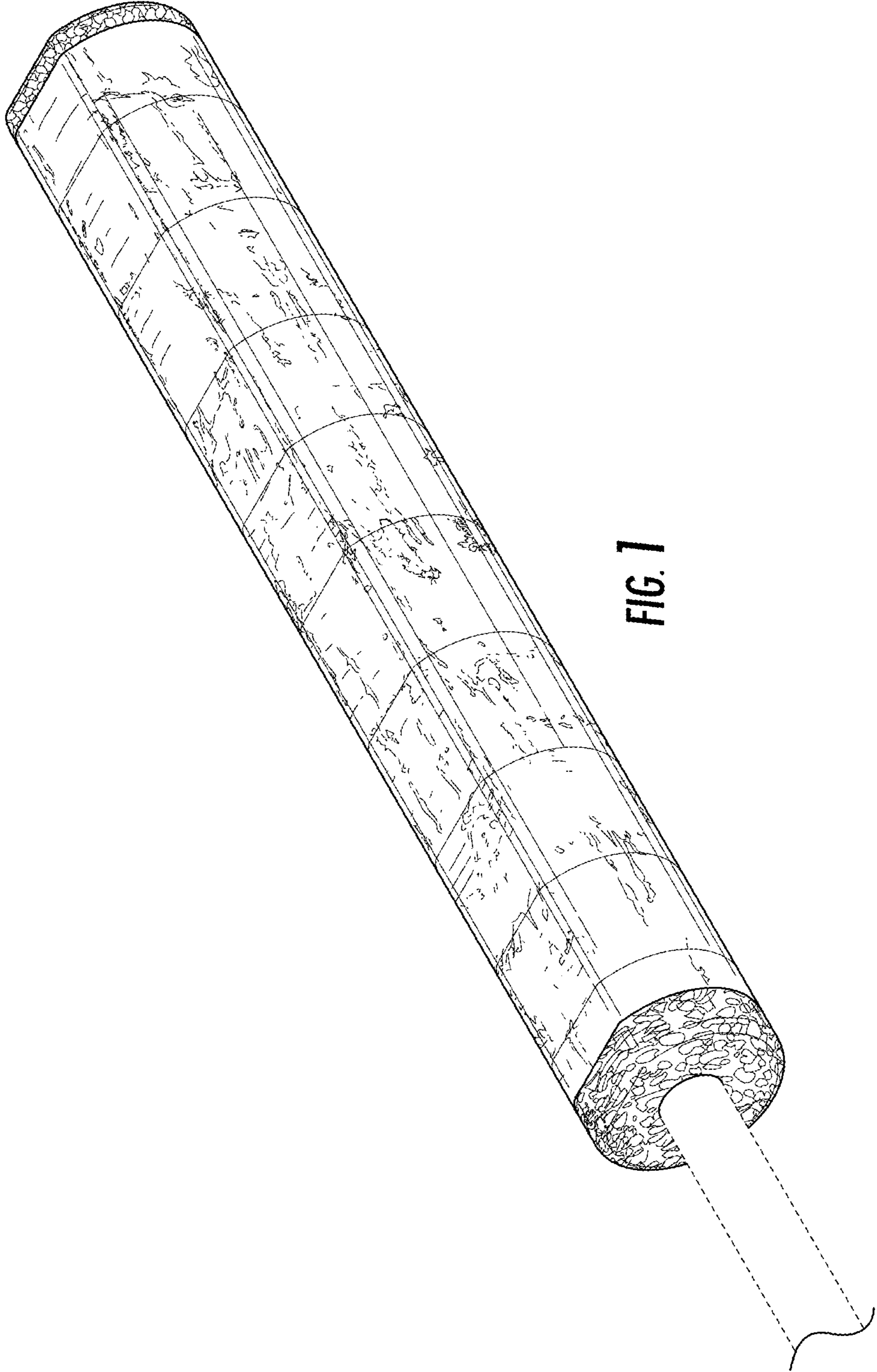

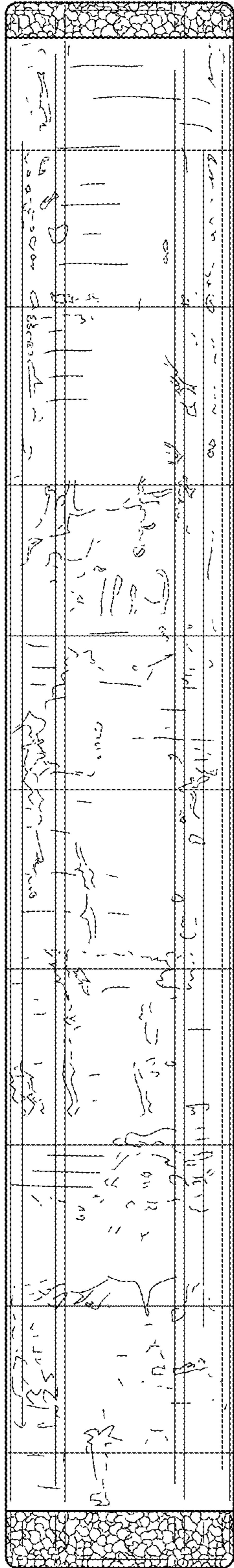

FIG. 2

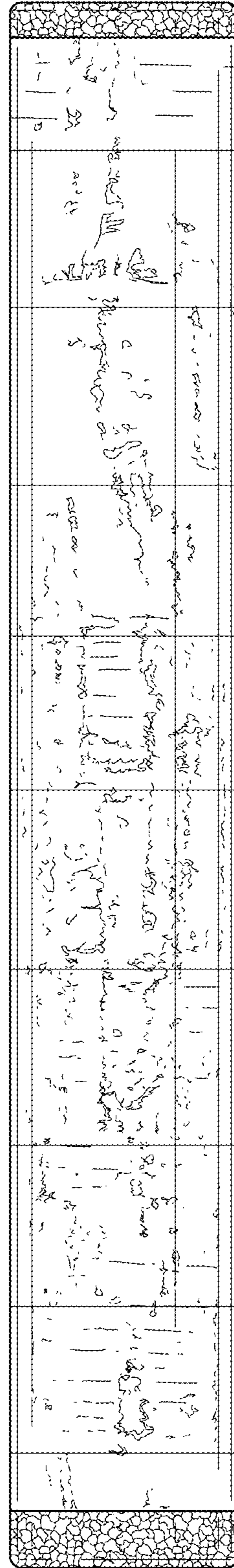

FIG. 3

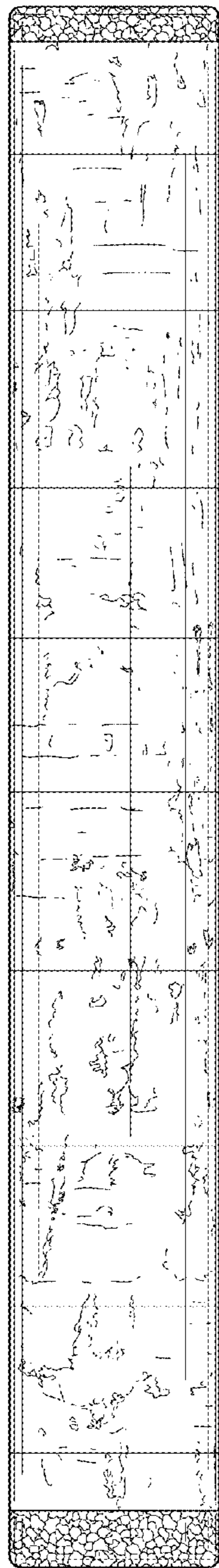

FIG. 4

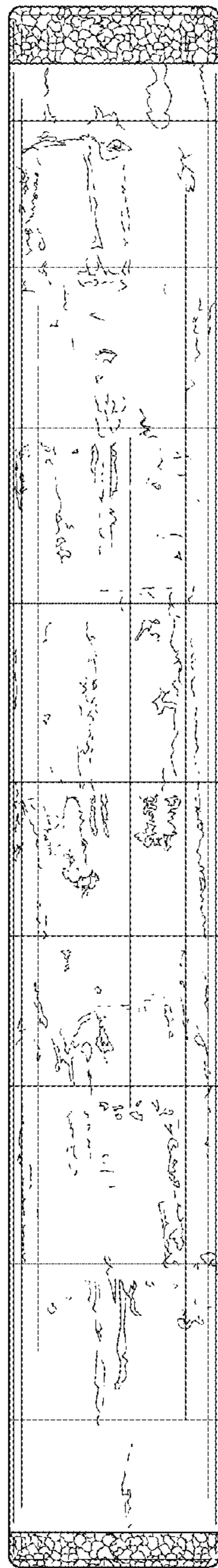

FIG. 5

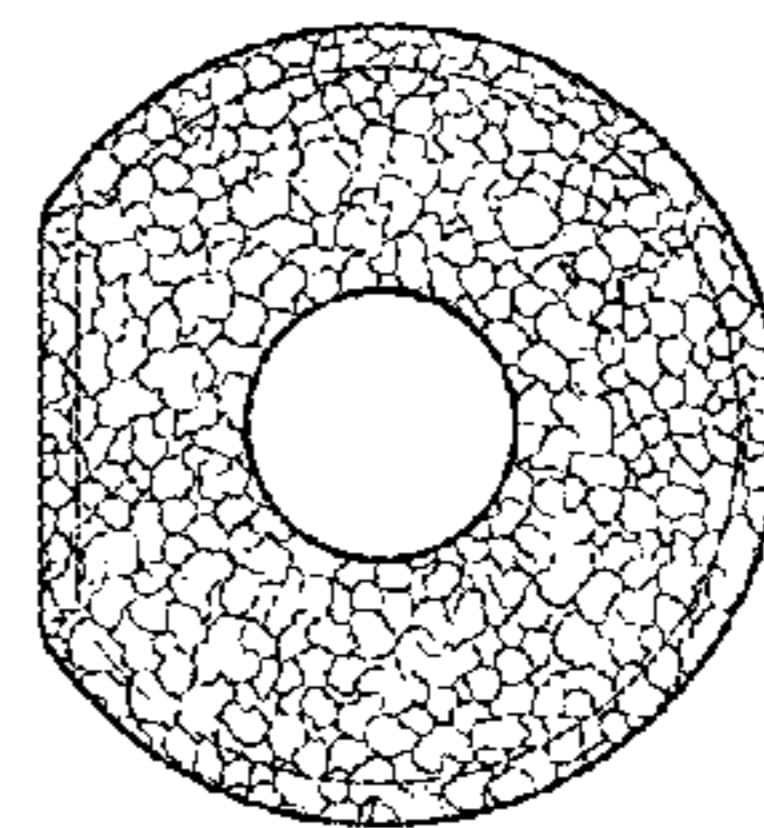

FIG. 6

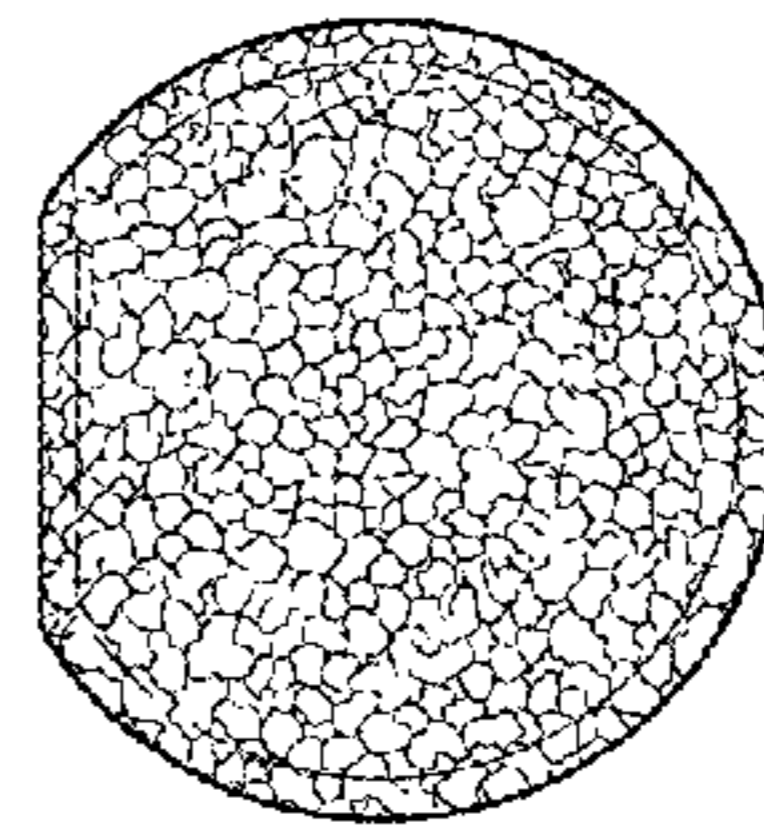

FIG. 7

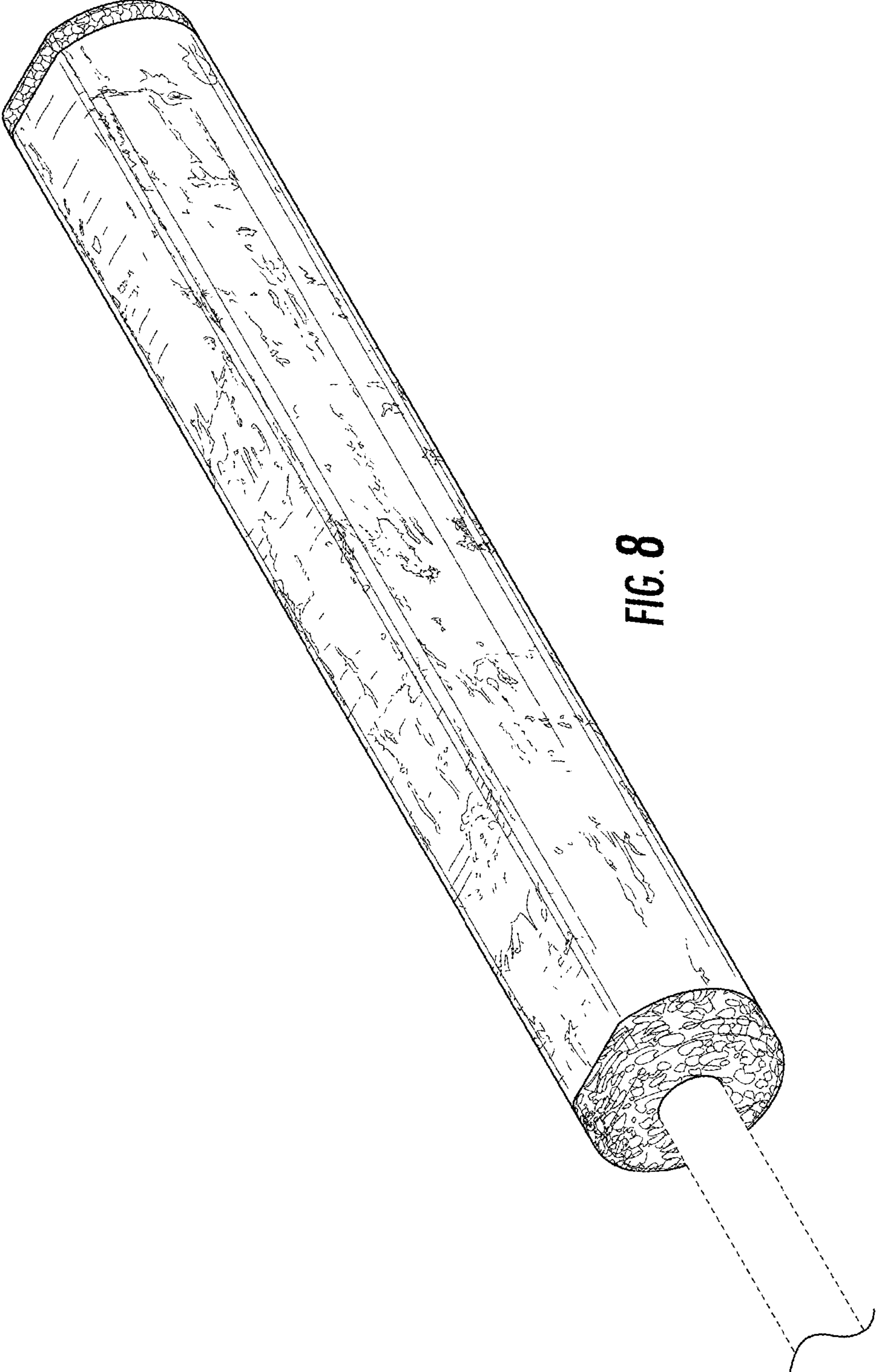

FIG. 8

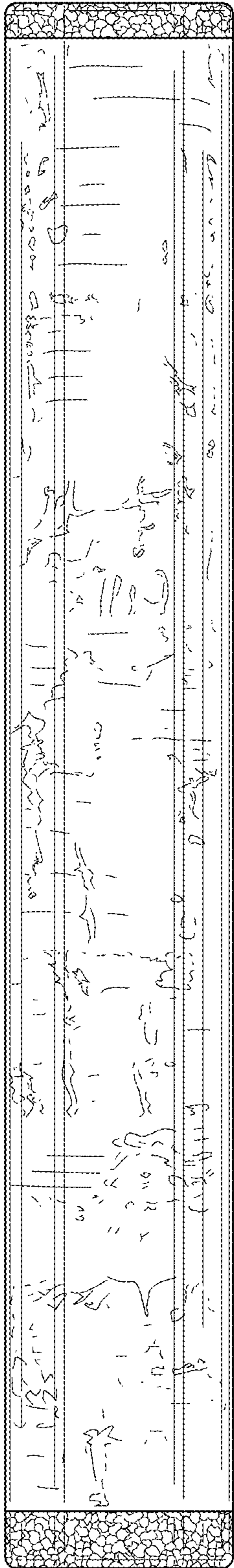

FIG. 9

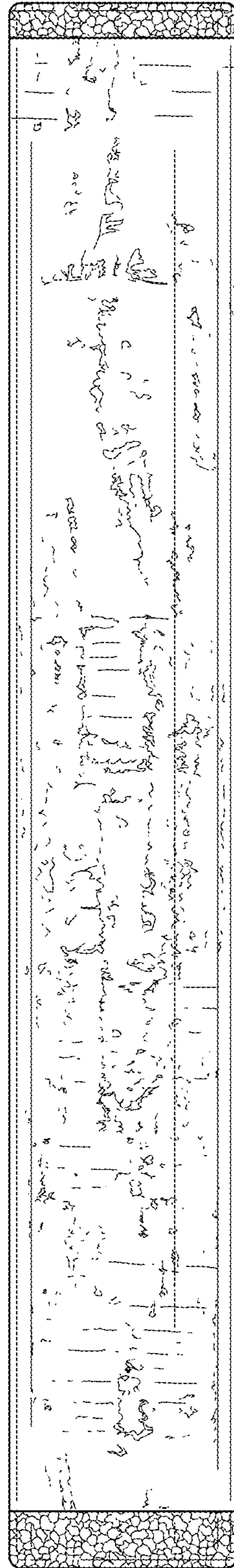

FIG. 10

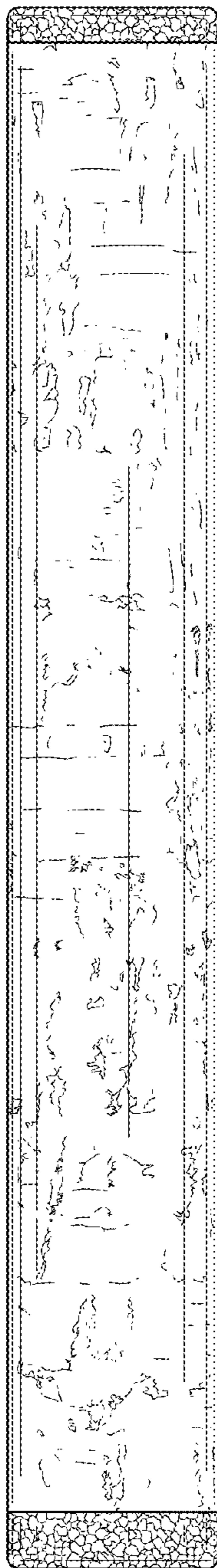

FIG. 11

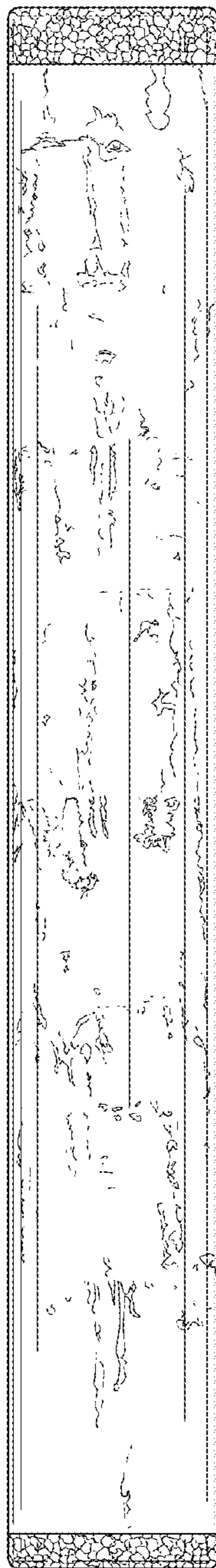

FIG. 12

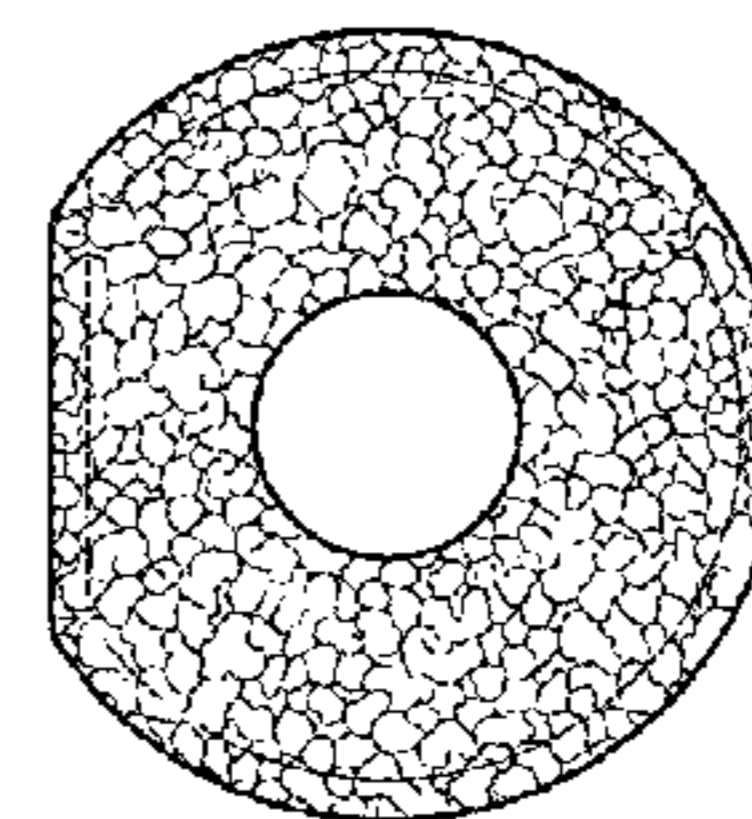

FIG. 13

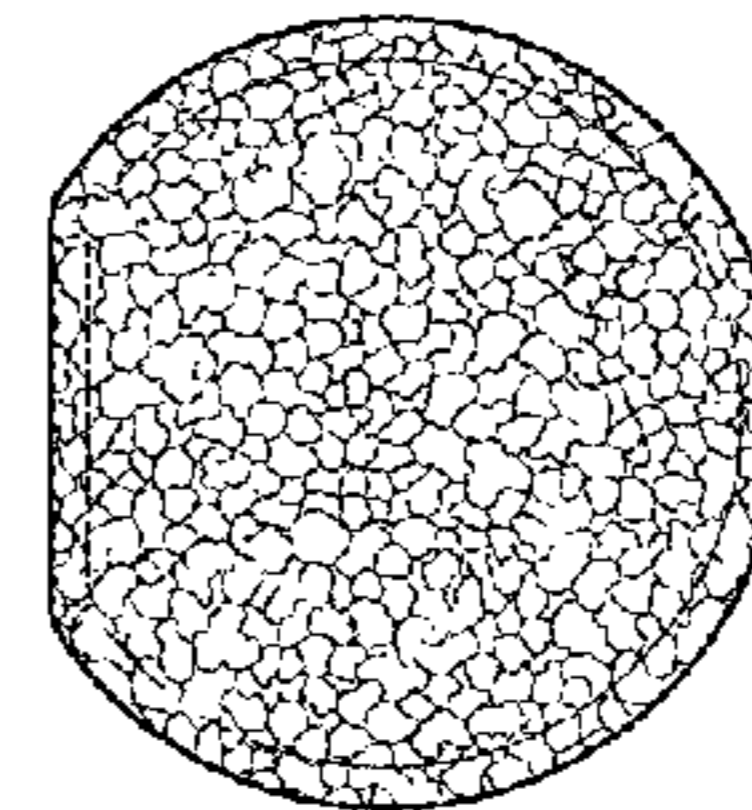

FIG. 14