



US00D695271S

(12) **United States Design Patent**
Hung et al.

(10) **Patent No.:** **US D695,271 S**

(45) **Date of Patent:** **** Dec. 10, 2013**

(54) **SPEAKER**

(71) Applicants: **Wei Wen Hung**, Shenzhen (CN); **David H. Pitcher**, Worcester, MA (US)

(72) Inventors: **Wei Wen Hung**, Shenzhen (CN); **David H. Pitcher**, Worcester, MA (US)

(73) Assignee: **Bose Corporation**, Framingham, MA (US)

(**) Term: **14 Years**

(21) Appl. No.: **29/440,122**

(22) Filed: **Dec. 19, 2012**

(51) **LOC (9) Cl.** **14-03**

(52) **U.S. Cl.**
USPC **D14/214**

(58) **Field of Classification Search**
USPC D14/172, 194, 196, 204, 207, 209.1,
D14/210–217, 219–222, 224; 181/143, 144,
181/147, 148, 150, 153, 157, 198, 199;
381/300–303, 306, 332, 333, 336, 345,
381/361–364, 386–388
See application file for complete search history.

(56) **References Cited**

U.S. PATENT DOCUMENTS

D318,054	S	*	7/1991	Kikutani	D14/214
D478,065	S	*	8/2003	Bolton et al.	D14/214
D531,988	S		11/2006	Green		
D558,184	S	*	12/2007	Carbone et al.	D14/214
D567,223	S	*	4/2008	Carbone et al.	D14/214
D575,272	S	*	8/2008	Shih et al.	D14/214
D659,676	S		5/2012	Aquillano et al.		
D687,413	S	*	8/2013	Yoshiizumi	D14/214

OTHER PUBLICATIONS

Bose Desktop Speakers Owner's Guide M3.2, 2007.

* cited by examiner

Primary Examiner — Keli L Hill

(74) *Attorney, Agent, or Firm* — Bose Corporation

(57) **CLAIM**

The ornamental design for a speaker, substantially as shown and described.

DESCRIPTION

FIG. 1 is a perspective view of a first embodiment of a speaker as seen from the front, top and right side;

FIG. 2 is a front view thereof;

FIG. 3 is a back view thereof;

FIG. 4 is a top view thereof;

FIG. 5 is a bottom view thereof;

FIG. 6 is a right side view thereof;

FIG. 7 is a left side view thereof;

FIG. 8 is a perspective view of a second embodiment of a speaker as seen from the front, top and right side;

FIG. 9 is a front view thereof;

FIG. 10 is a back view thereof;

FIG. 11 is a top view thereof;

FIG. 12 is a bottom view thereof;

FIG. 13 is a right side view thereof;

FIG. 14 is a left side view thereof;

FIG. 15 is a perspective view of a third embodiment of a speaker as seen from the front, top and right side;

FIG. 16 is a front view thereof;

FIG. 17 is a back view thereof;

FIG. 18 is a top view thereof;

FIG. 19 is a bottom view thereof;

FIG. 20 is a right side view thereof;

FIG. 21 is a left side view thereof;

FIG. 22 is a perspective view of a fourth embodiment of a speaker as seen from the front, top and right side;

FIG. 23 is a front view thereof;

FIG. 24 is a back view thereof;

FIG. 25 is a top view thereof;

FIG. 26 is a bottom view thereof;

FIG. 27 is a right side view thereof; and,

FIG. 28 is a left side view thereof.

The dotted line portions of the drawings represent environmental structure only and do not form part of the claimed design.

1 Claim, 28 Drawing Sheets

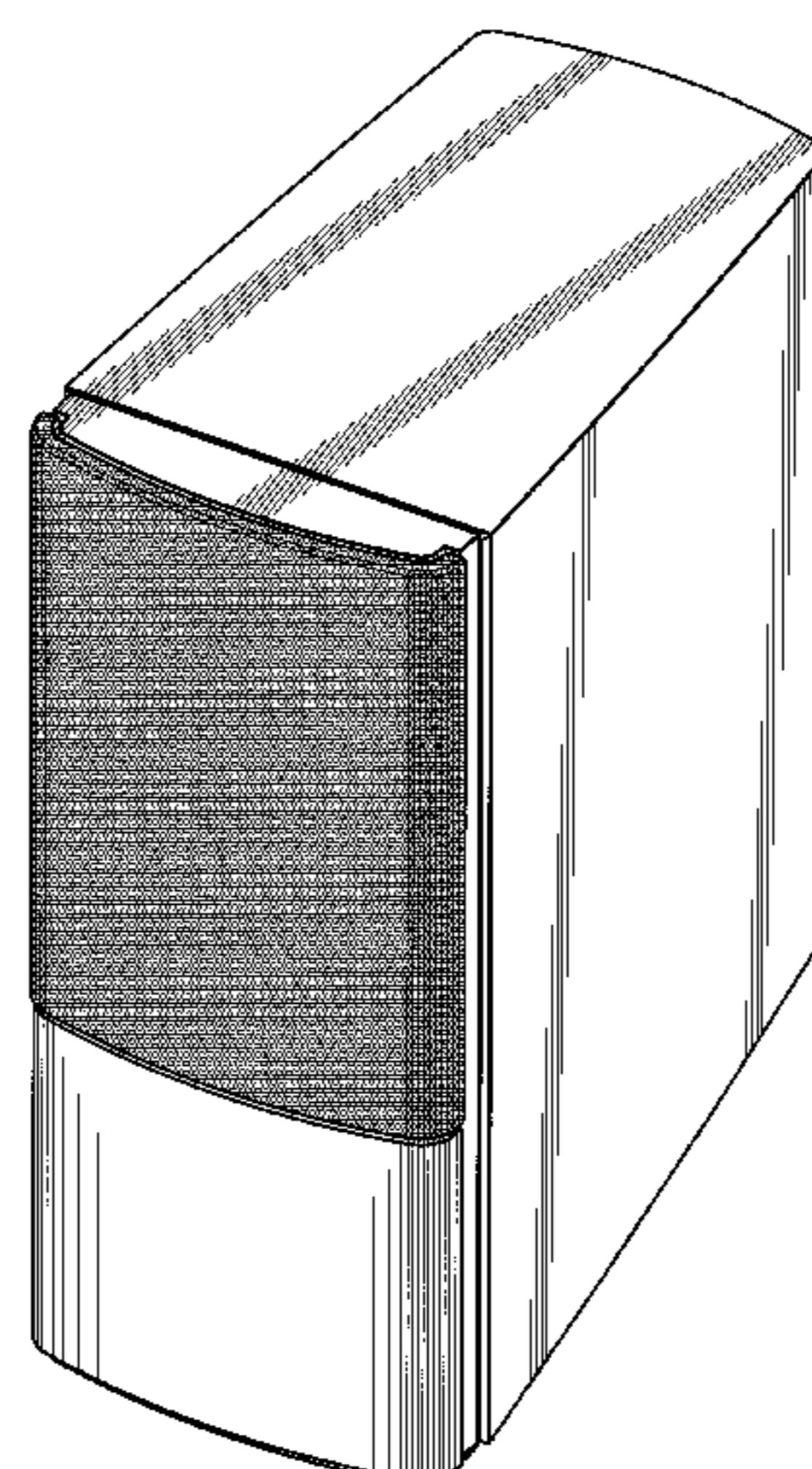
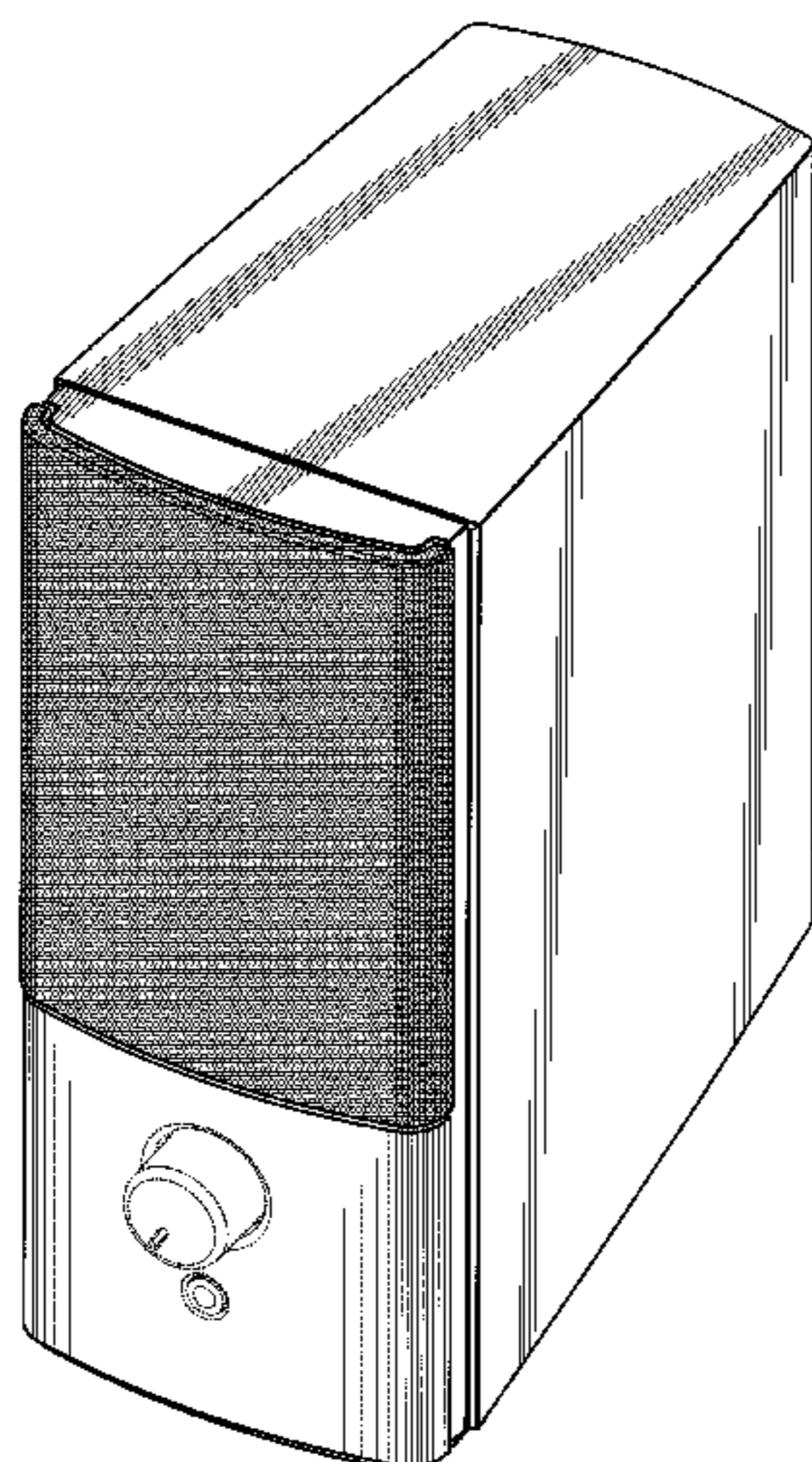

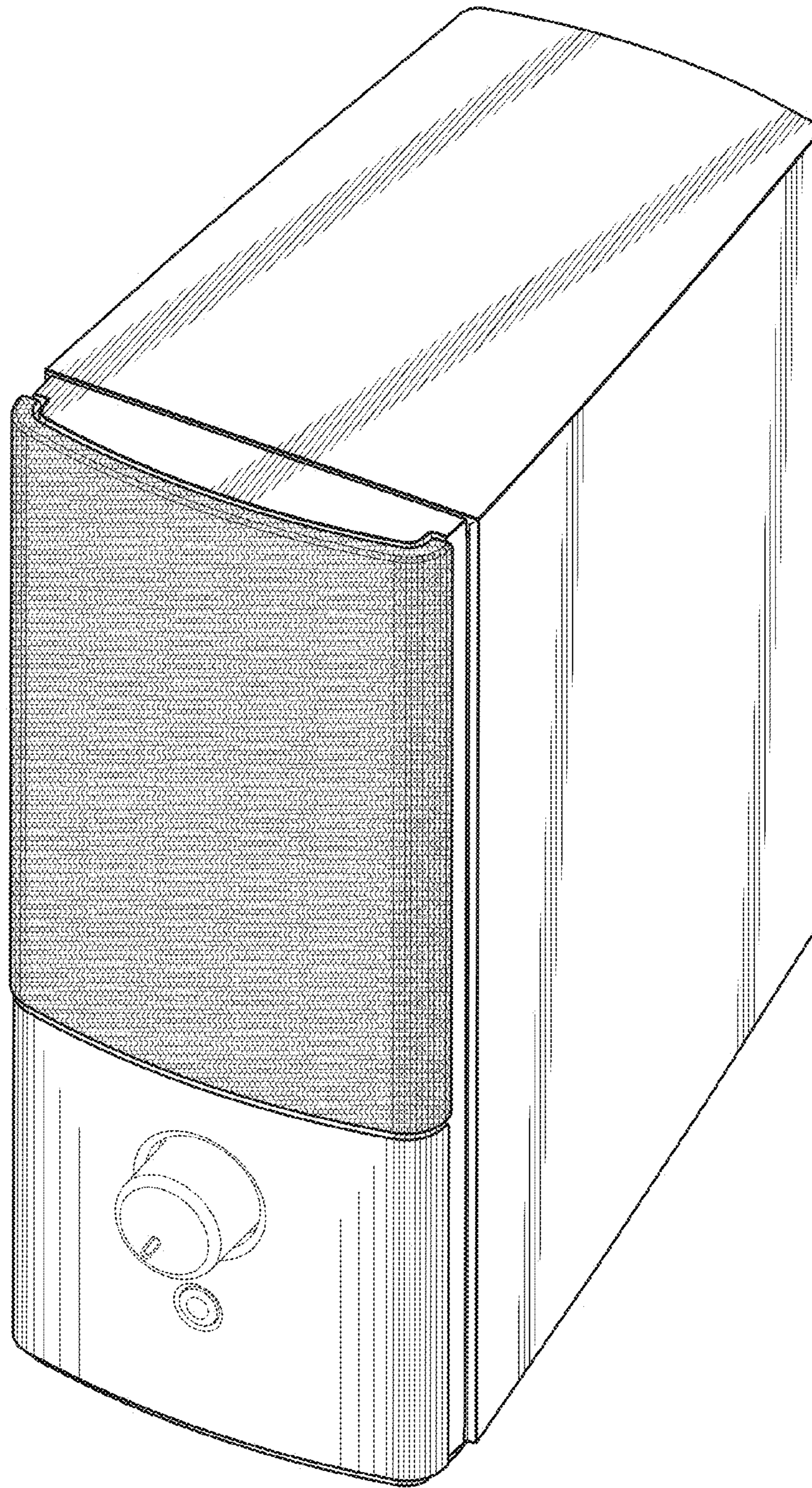

FIG. 1

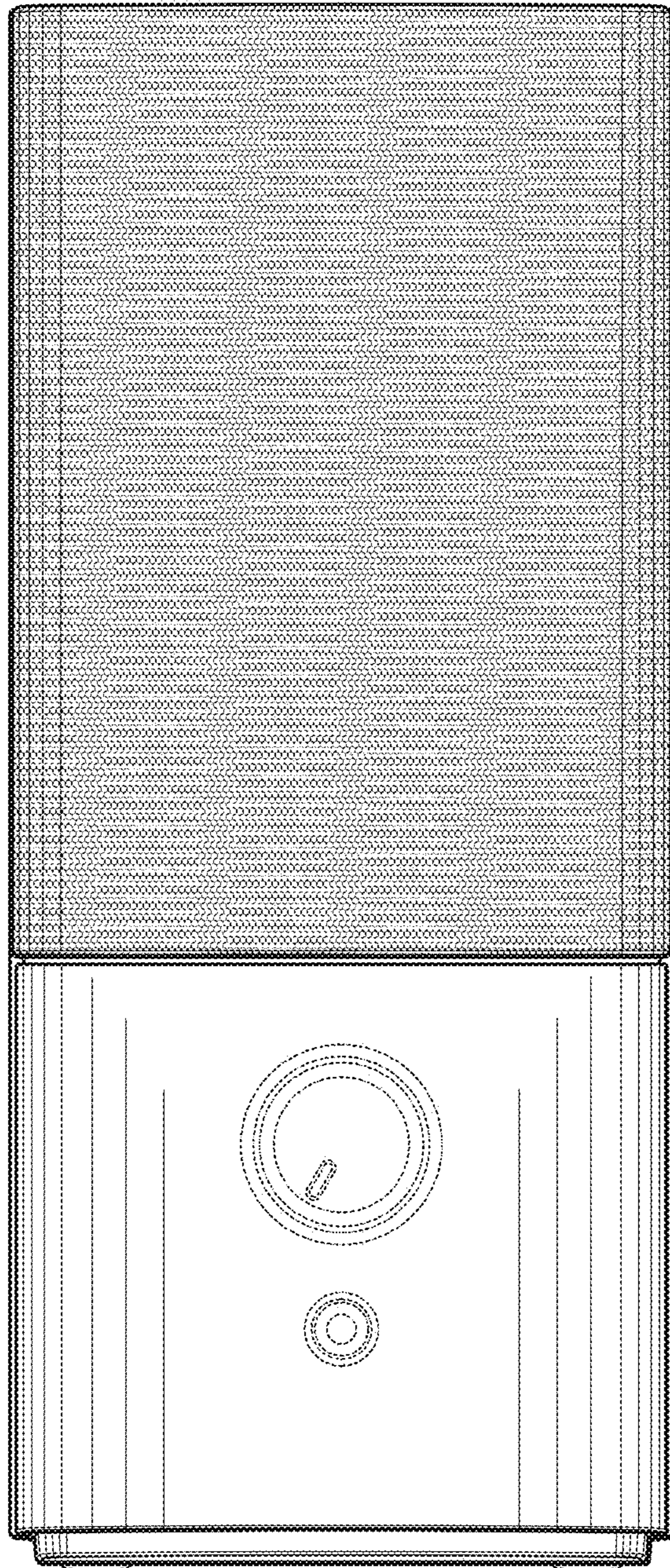

FIG. 2

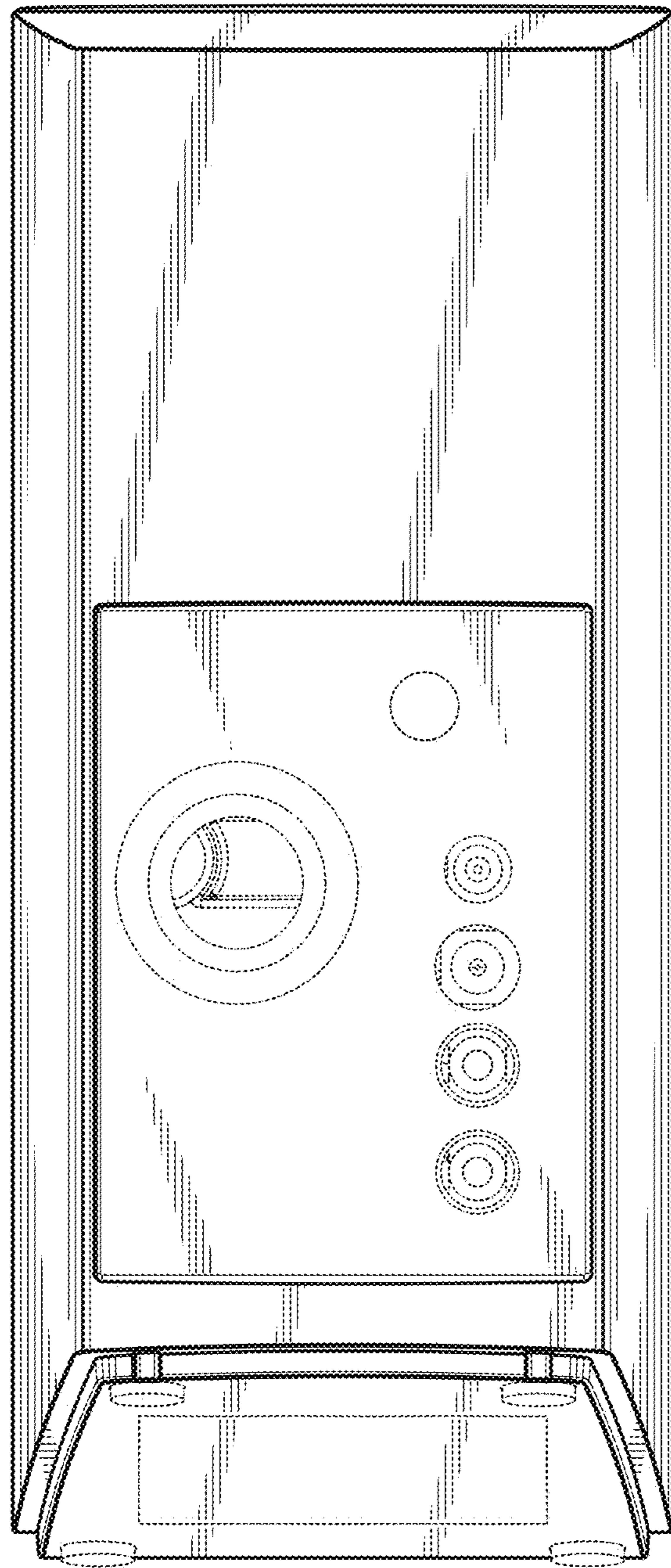

FIG. 3

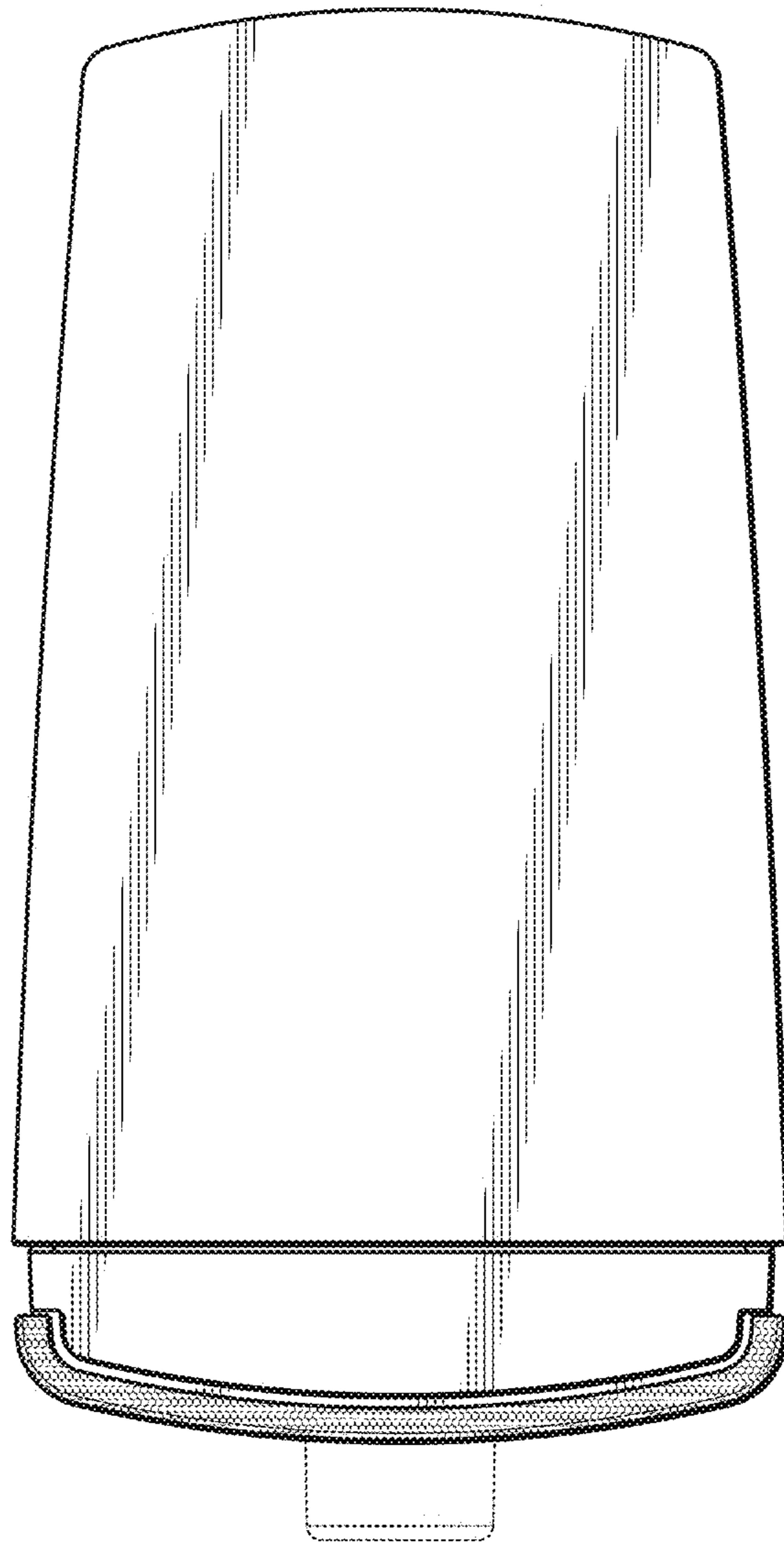

FIG. 4

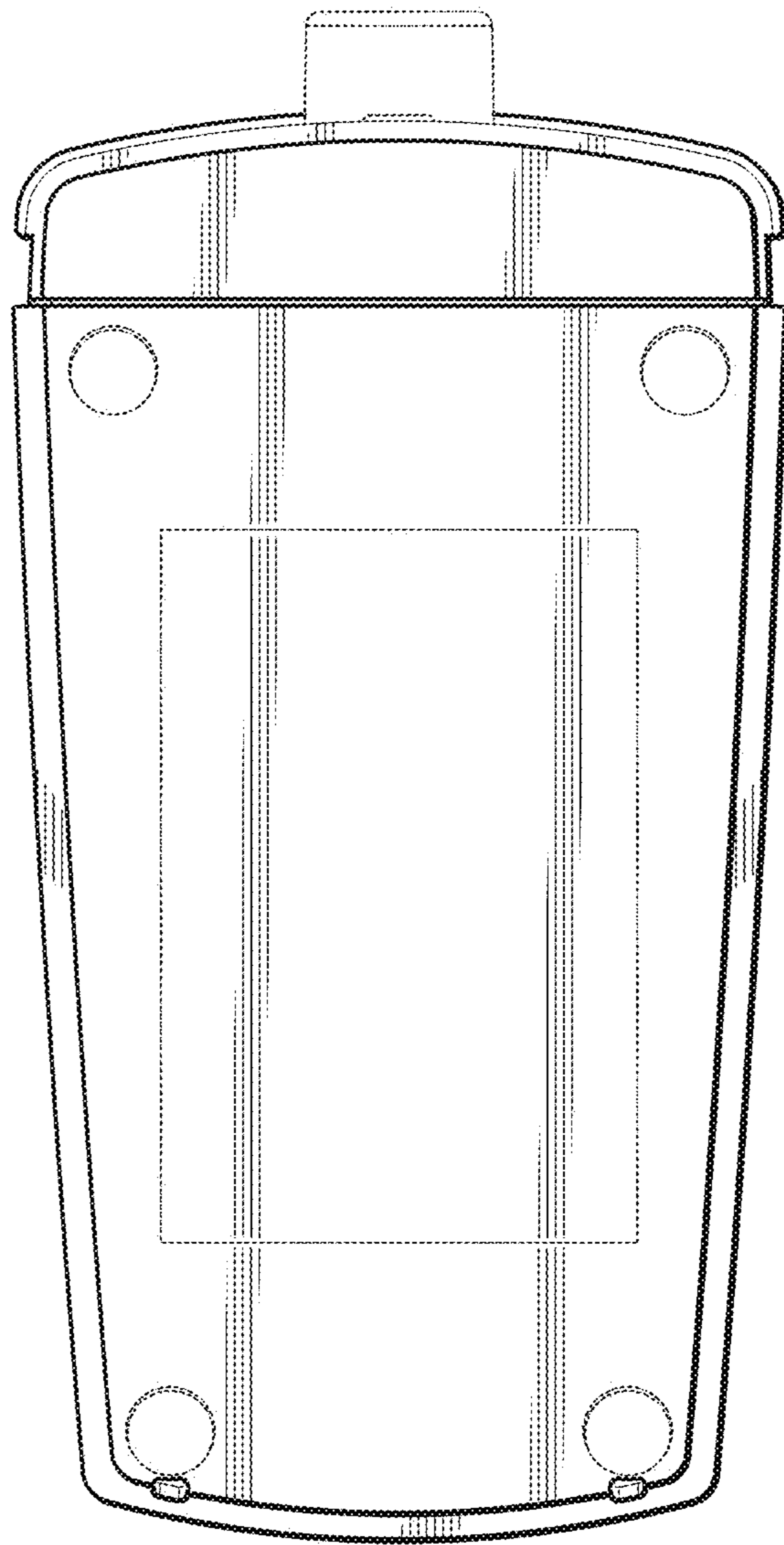

FIG. 5

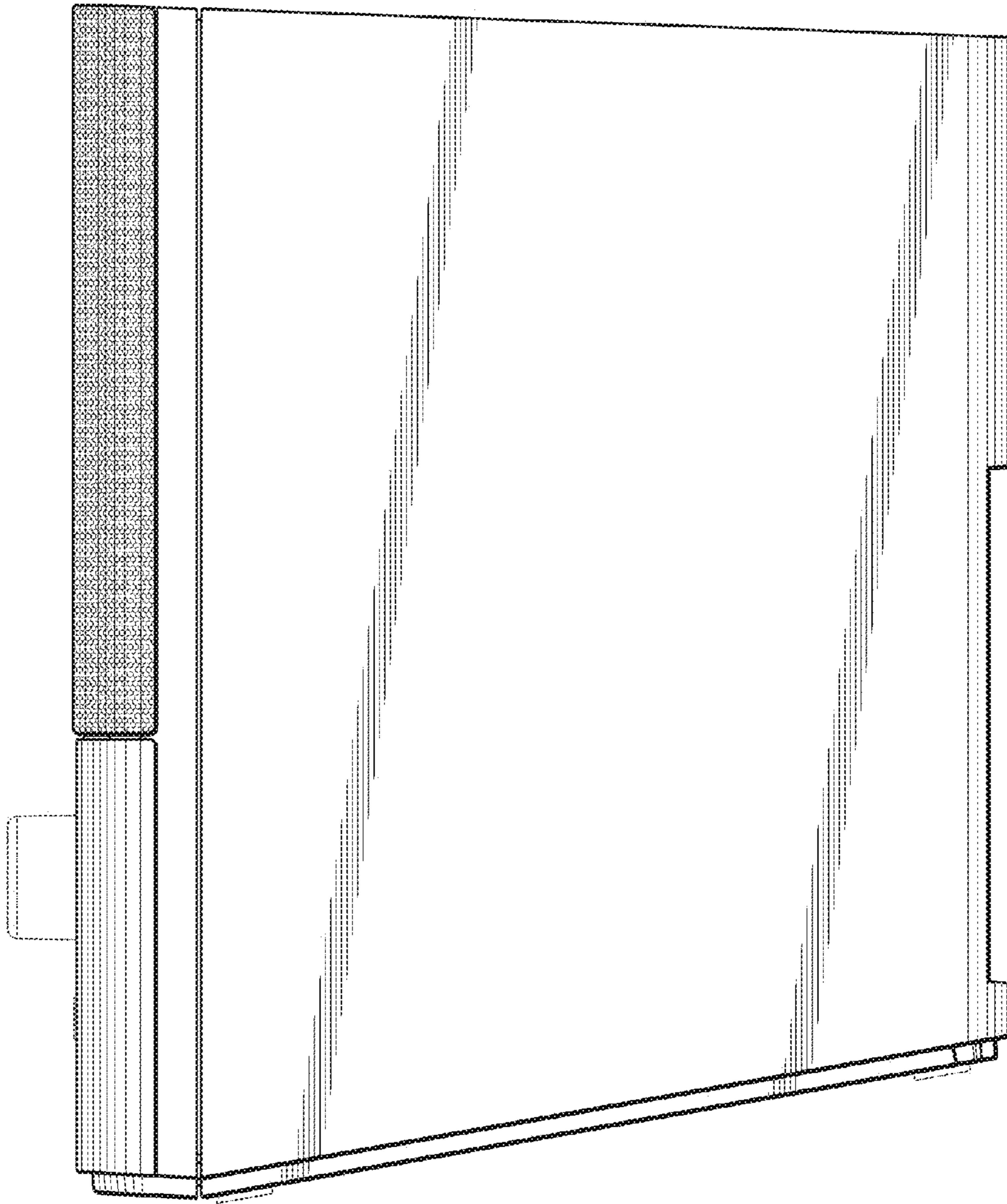

FIG. 6

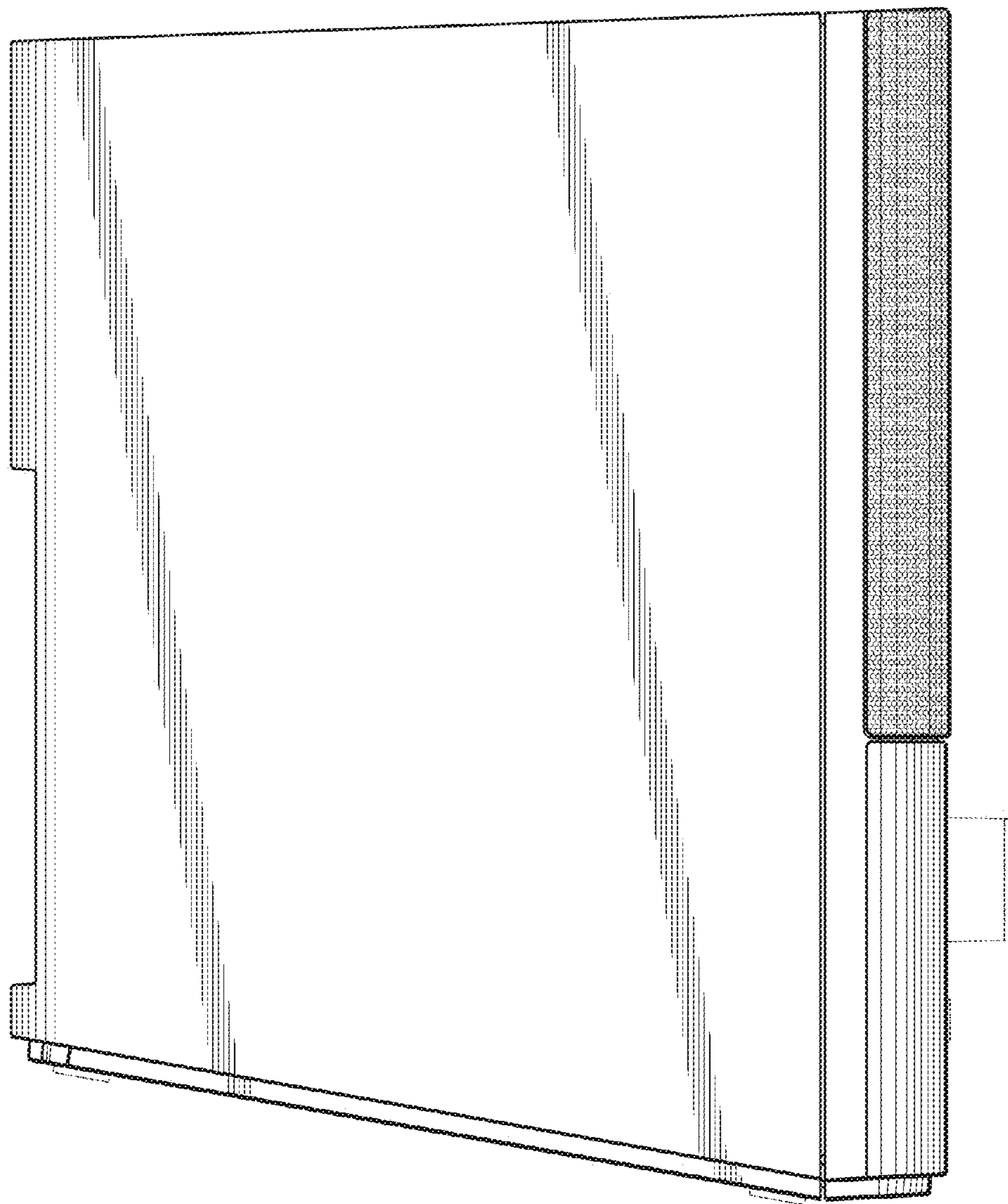

FIG. 7

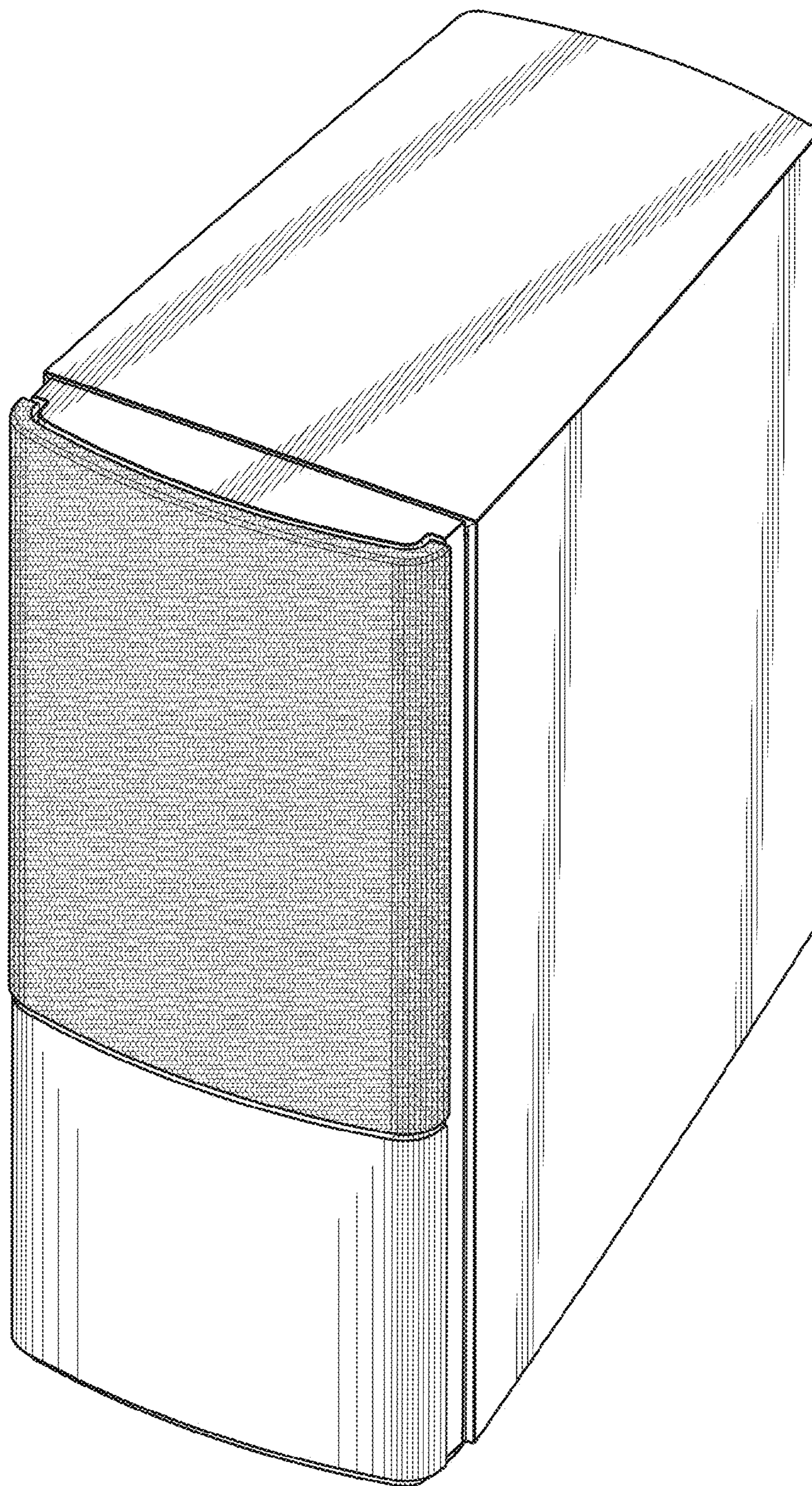

FIG. 8

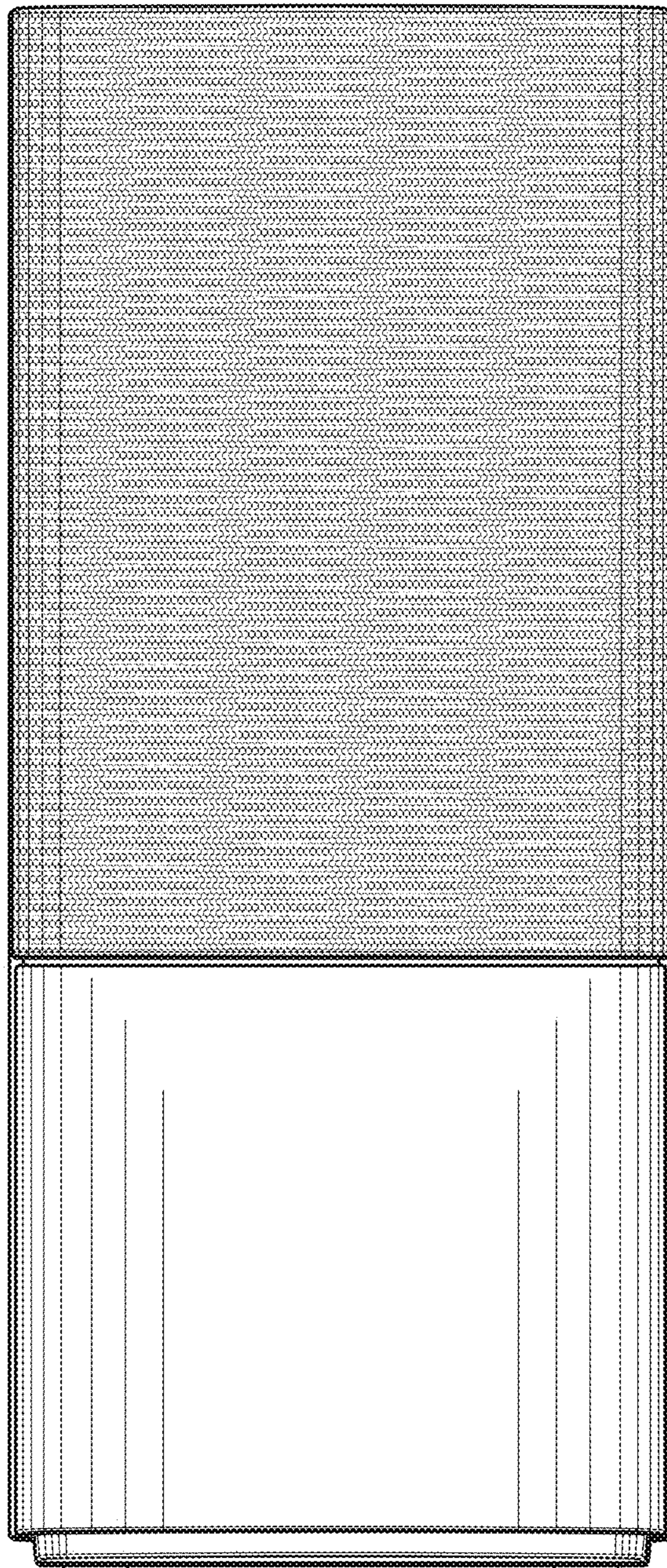

FIG. 9

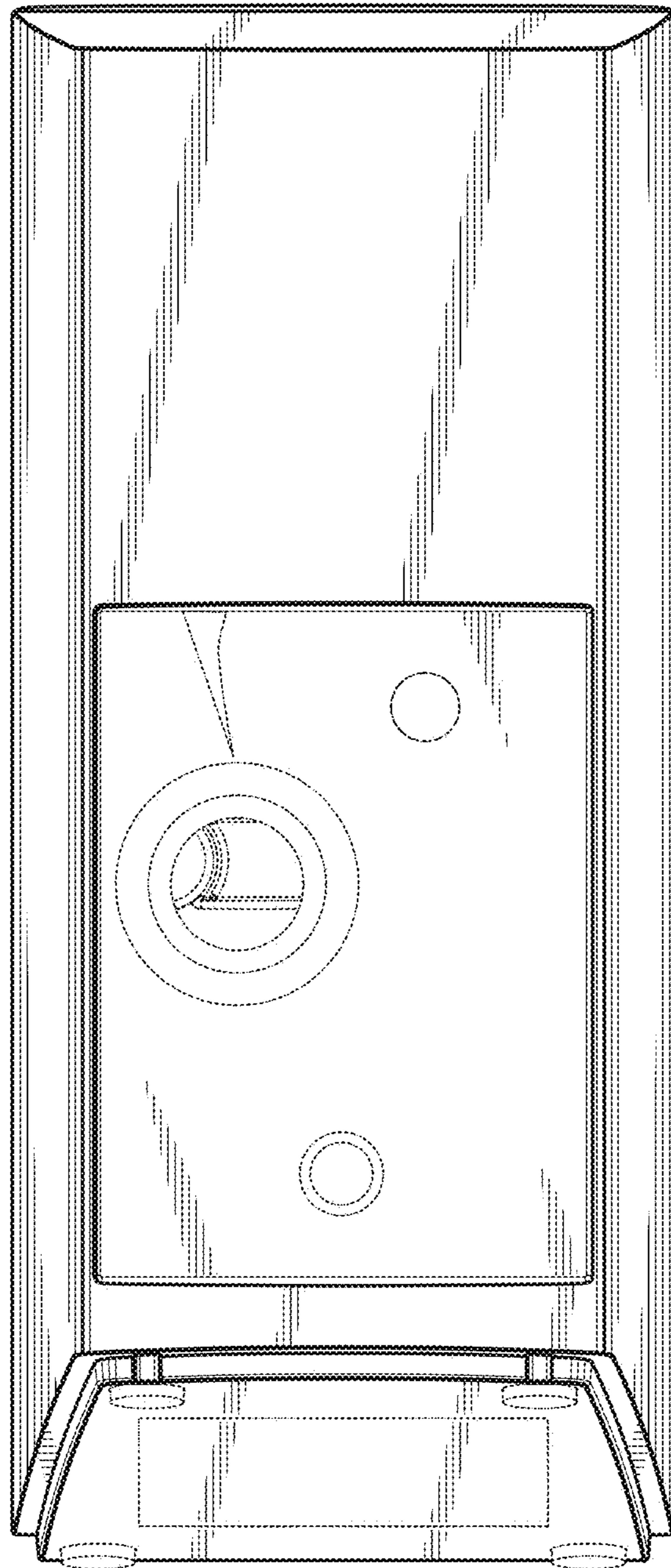

FIG. 10

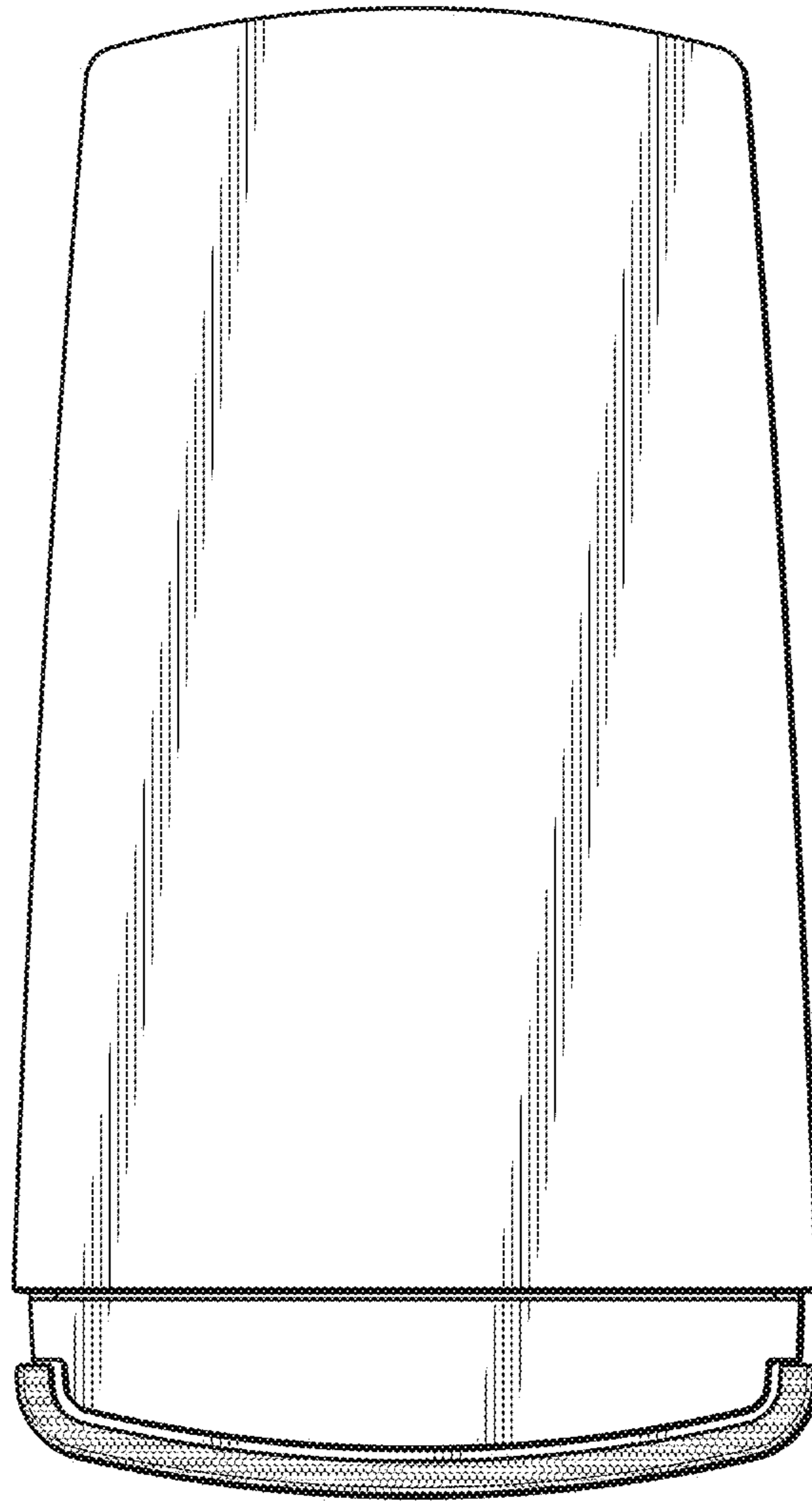

FIG. 11

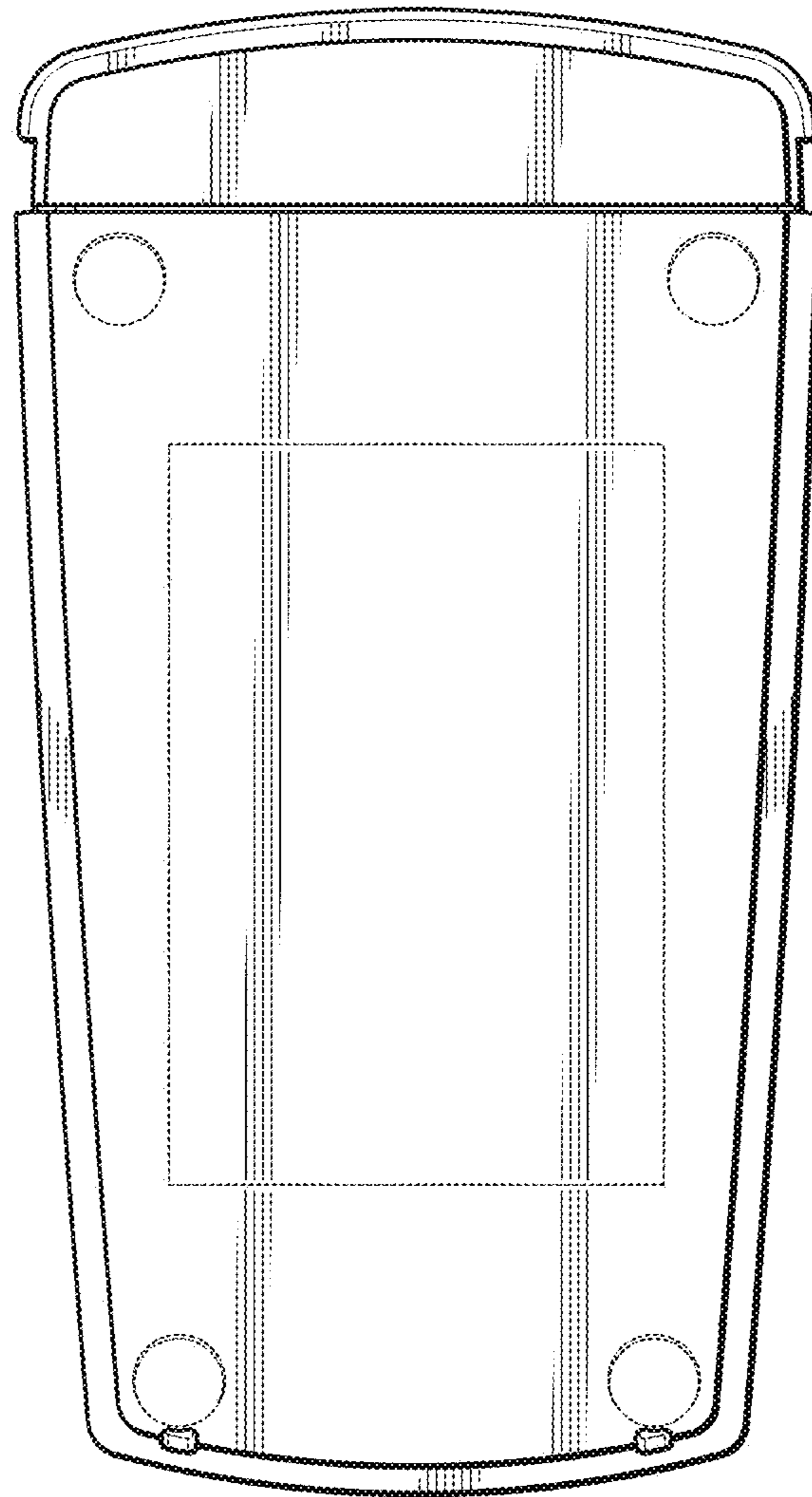

FIG. 12

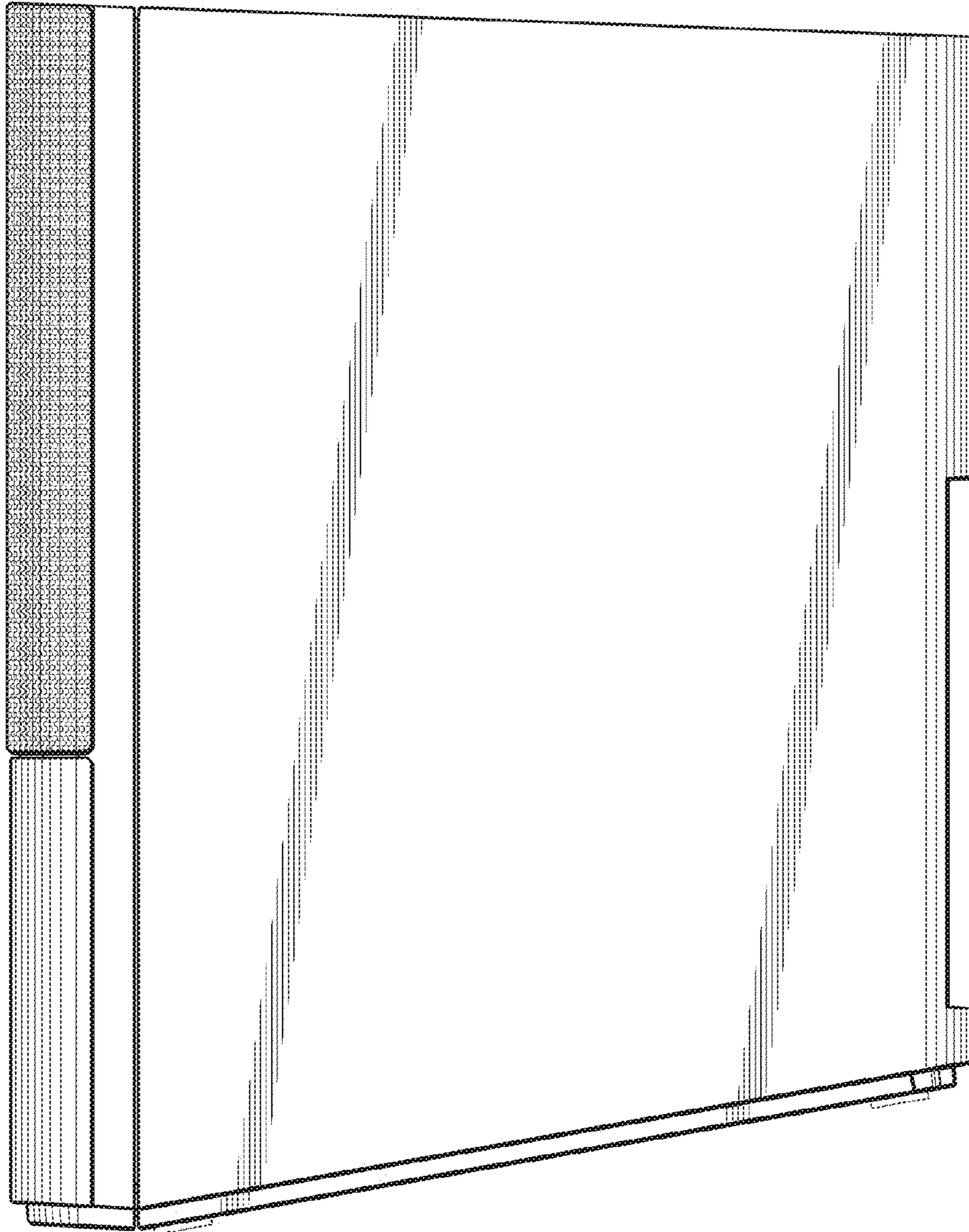

FIG. 13

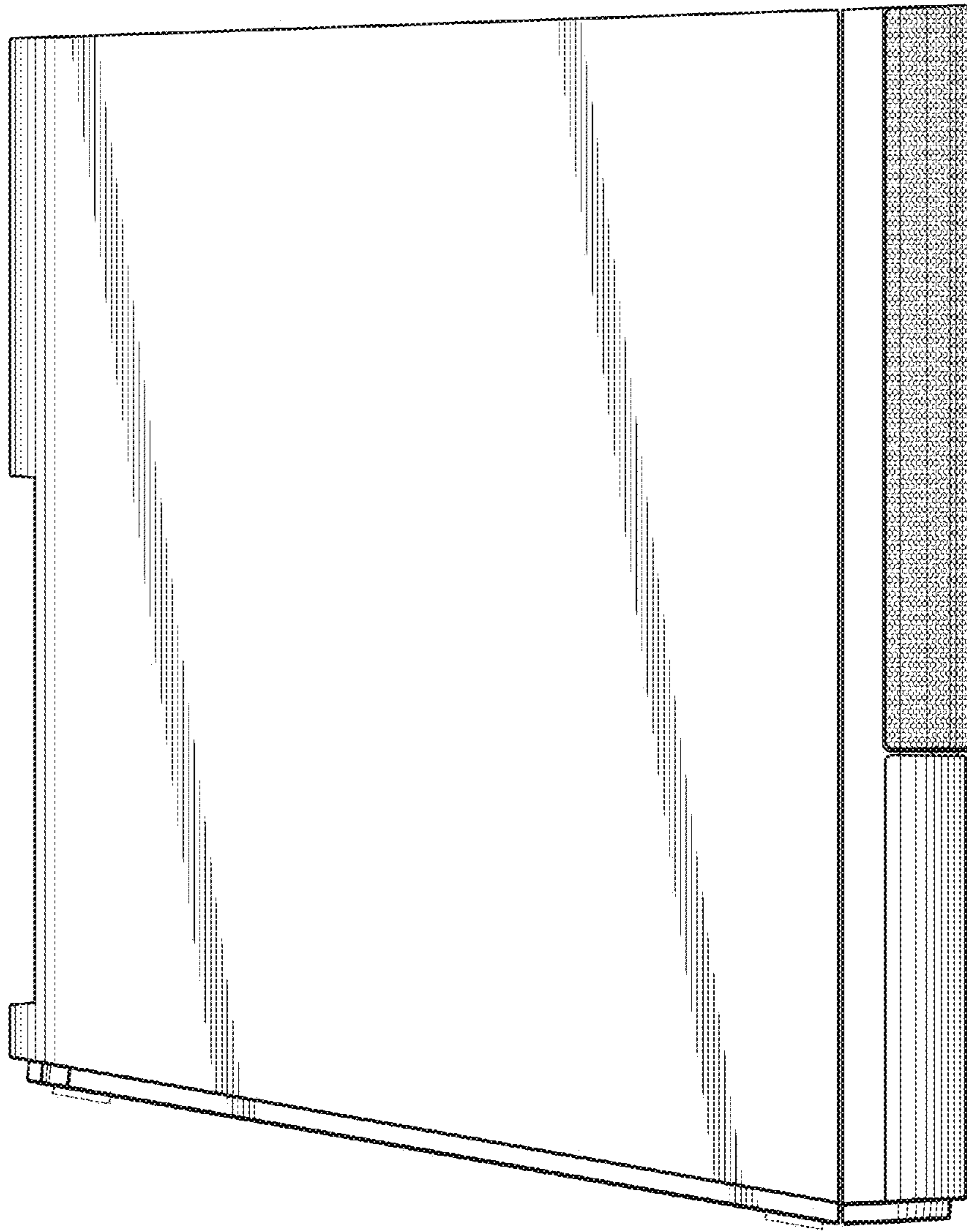

FIG. 14

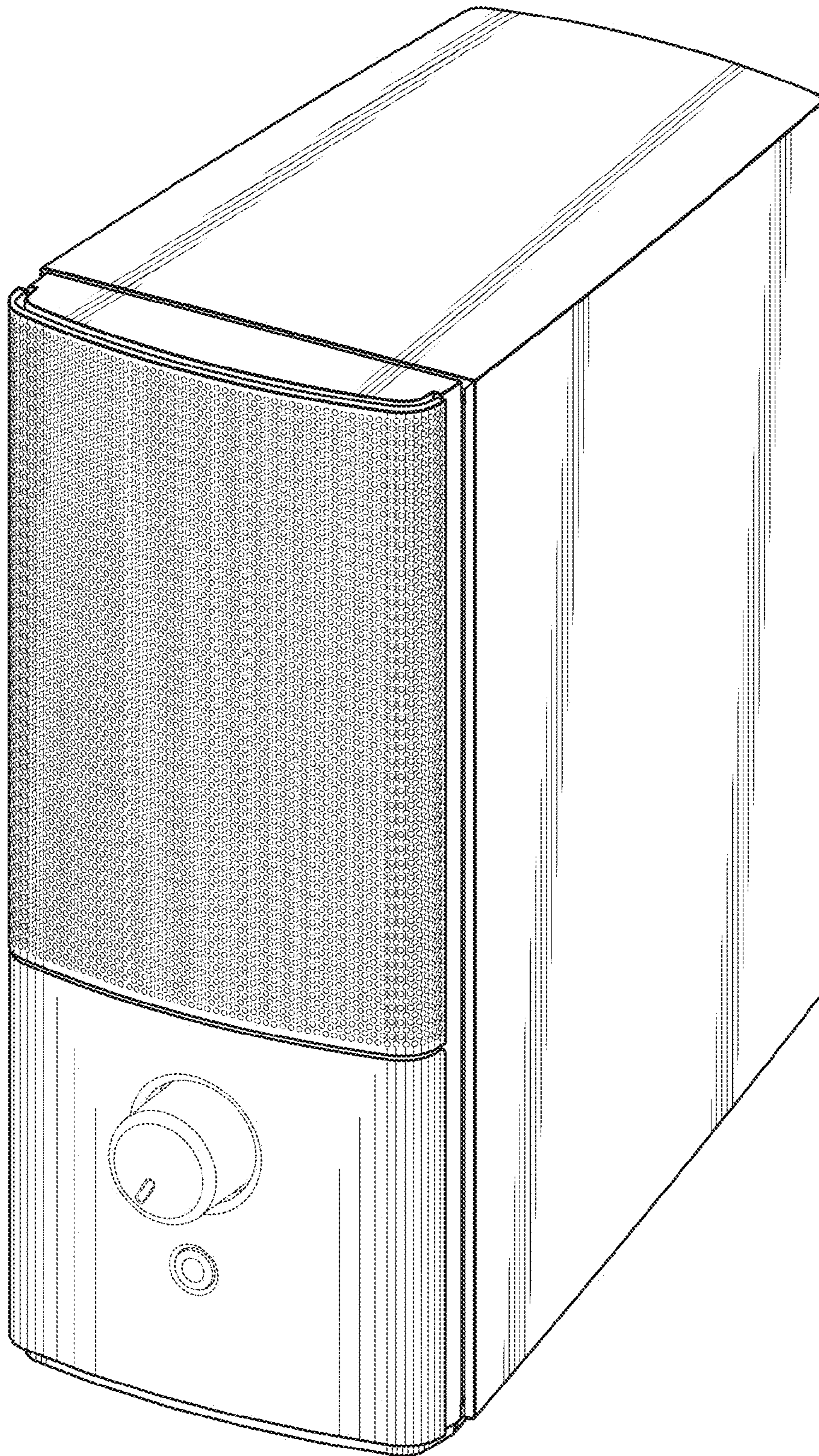

FIG. 15

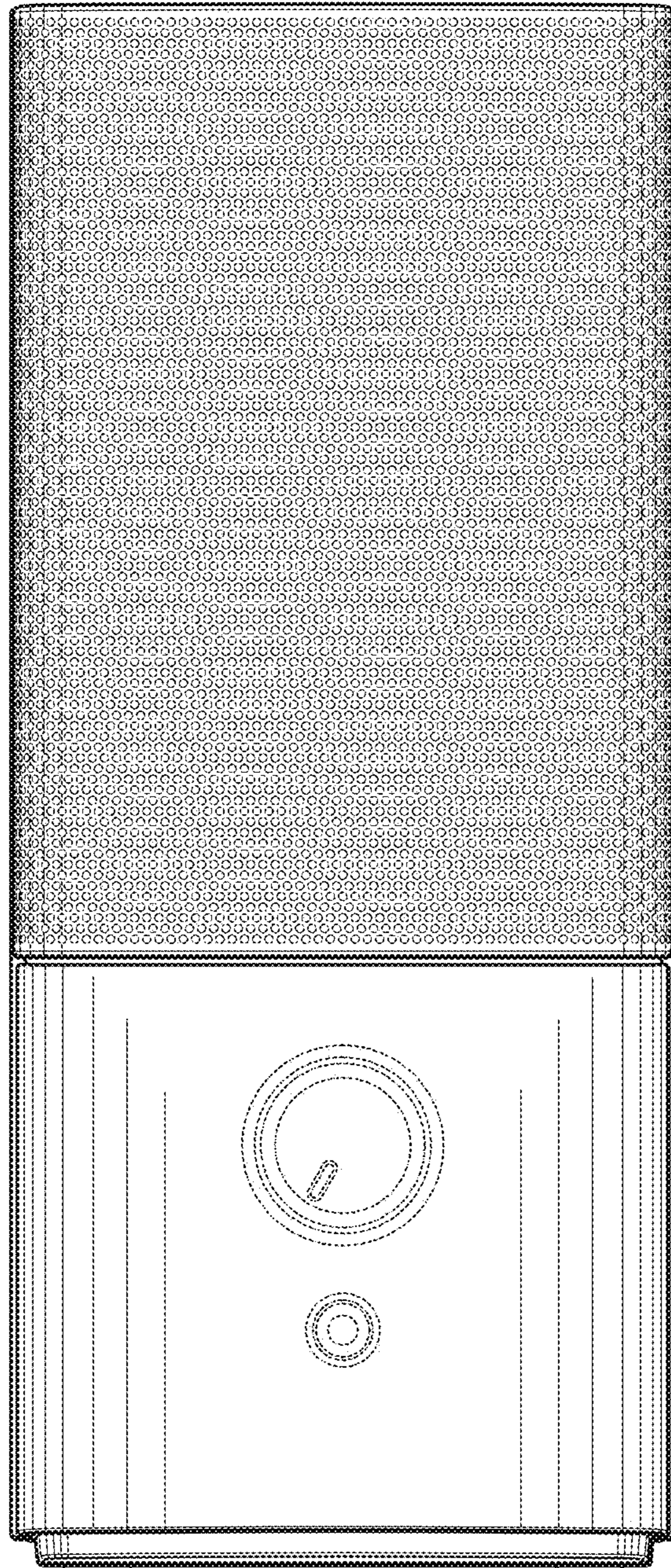

FIG. 16

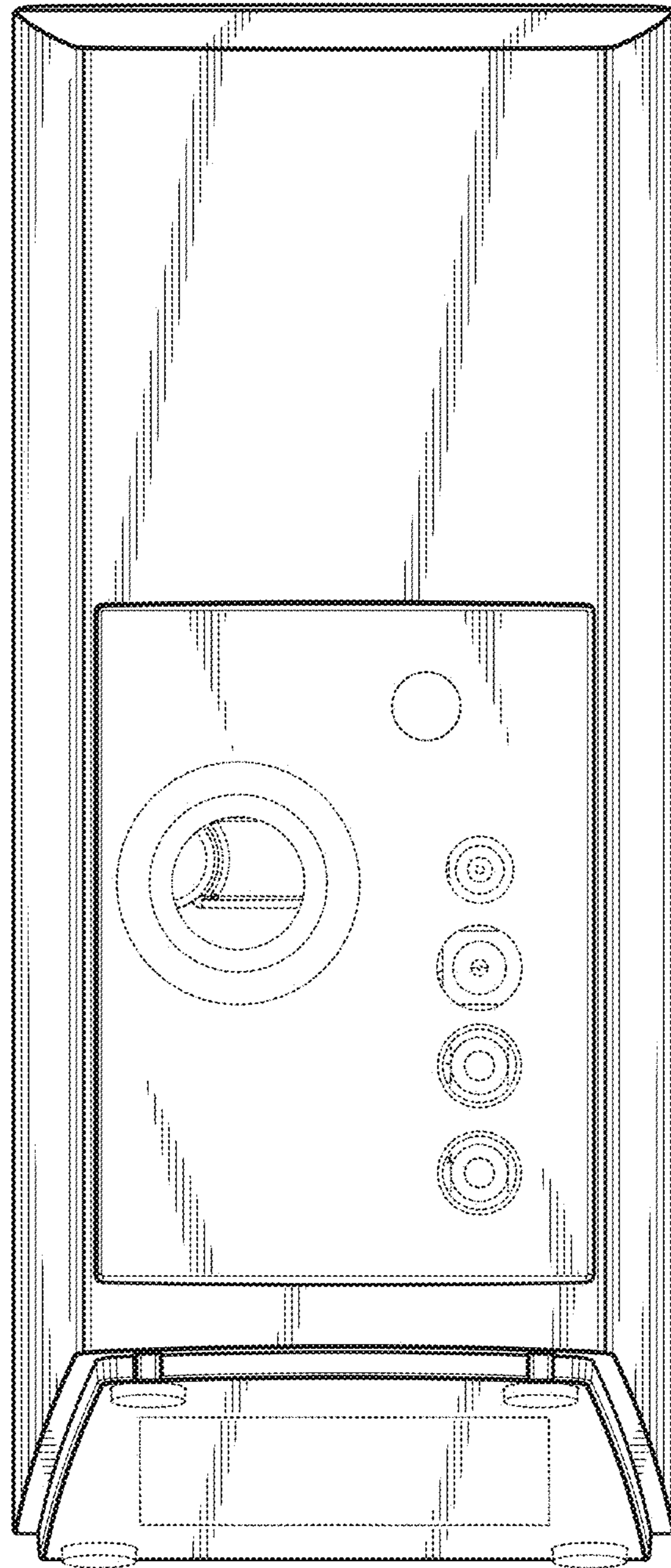

FIG. 17

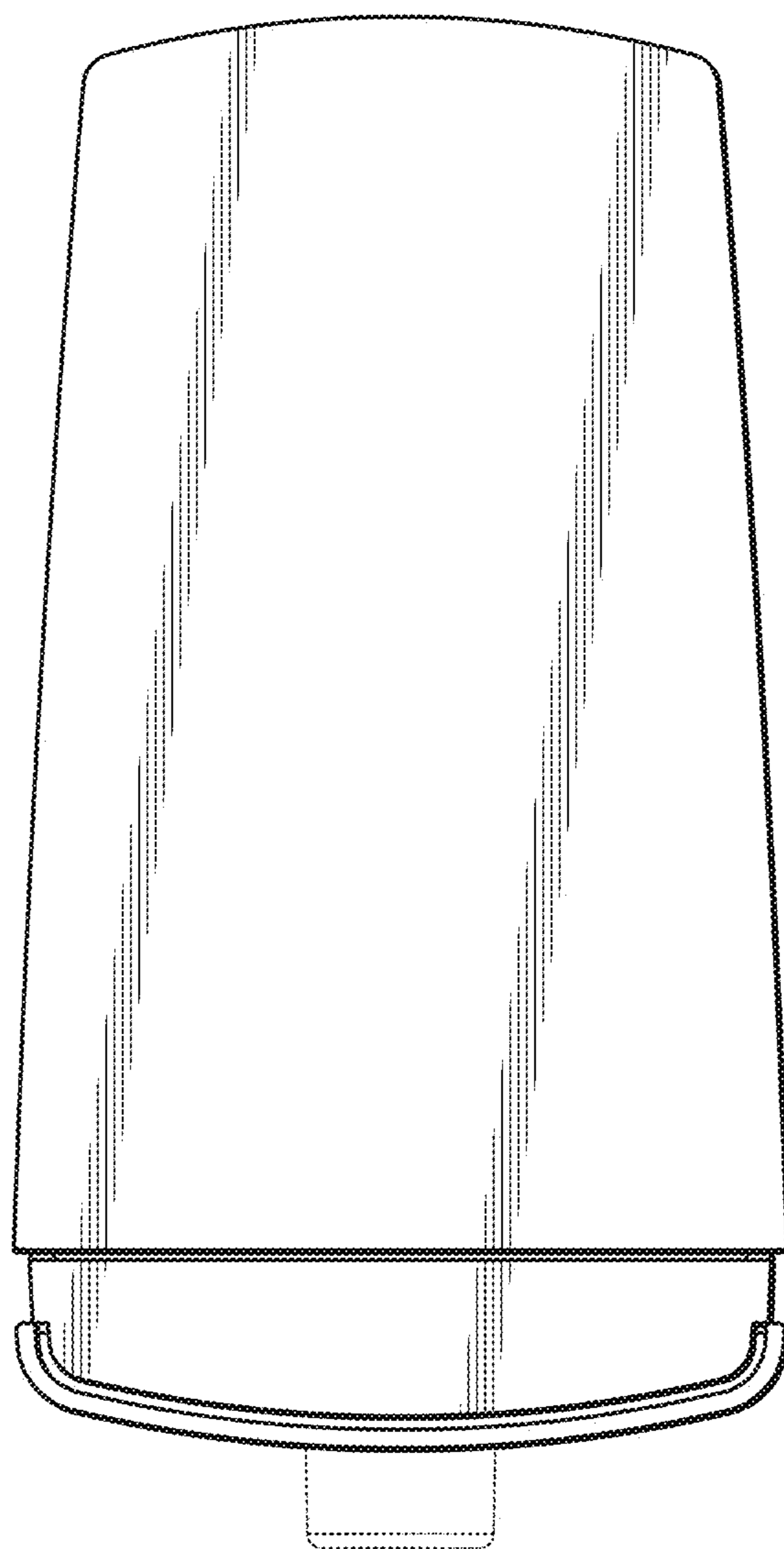

FIG. 18

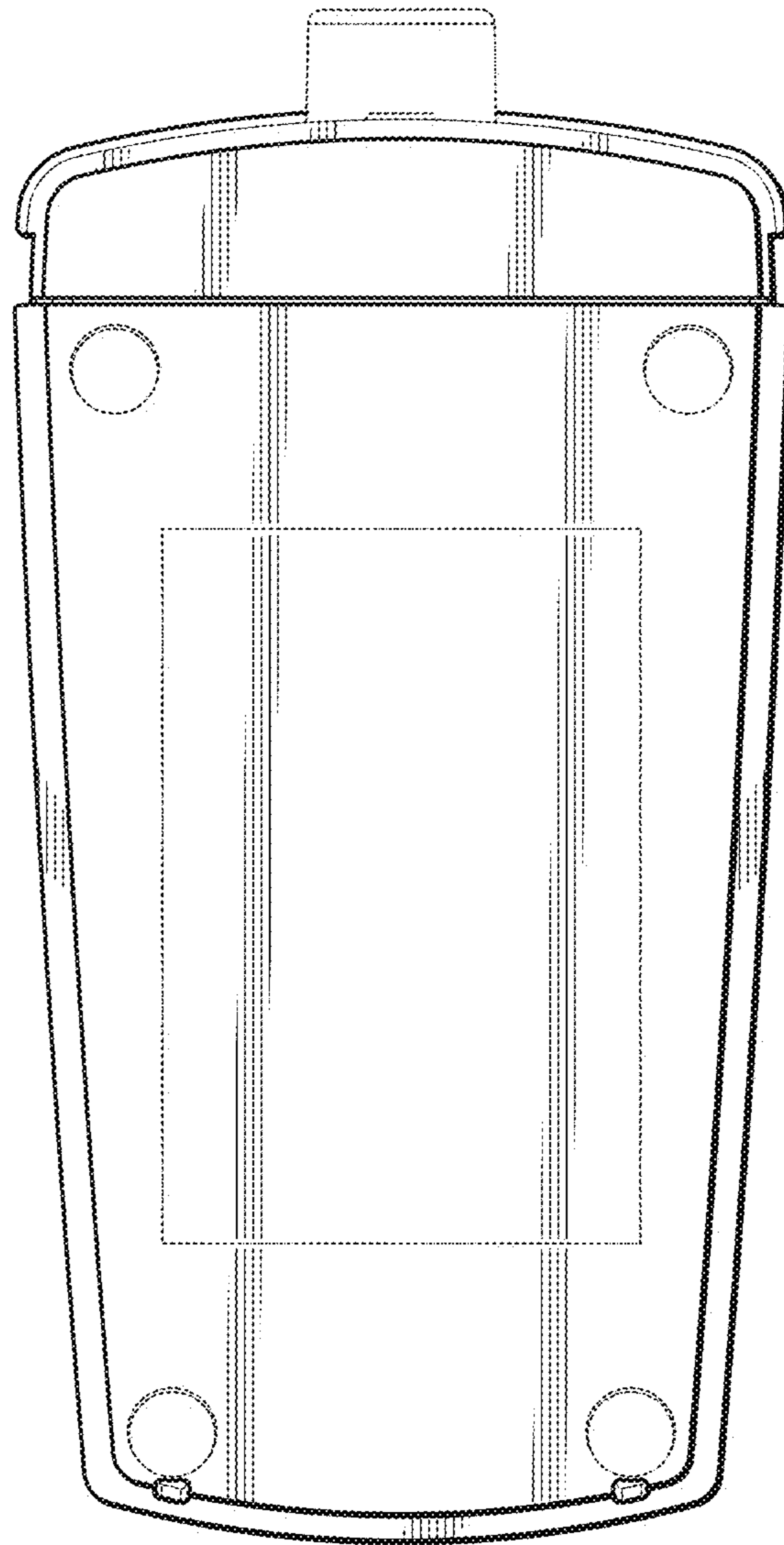

FIG. 19

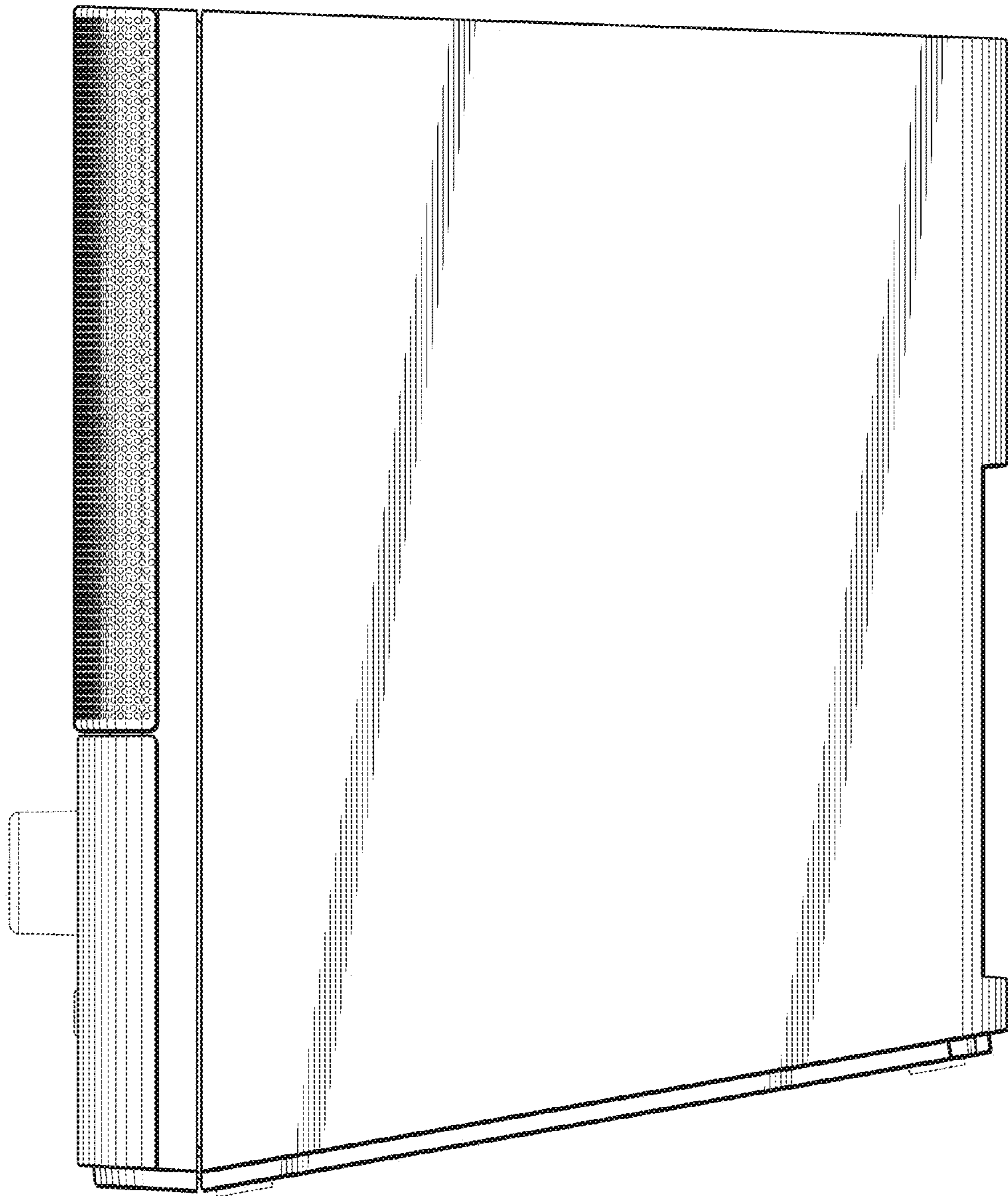

FIG. 20

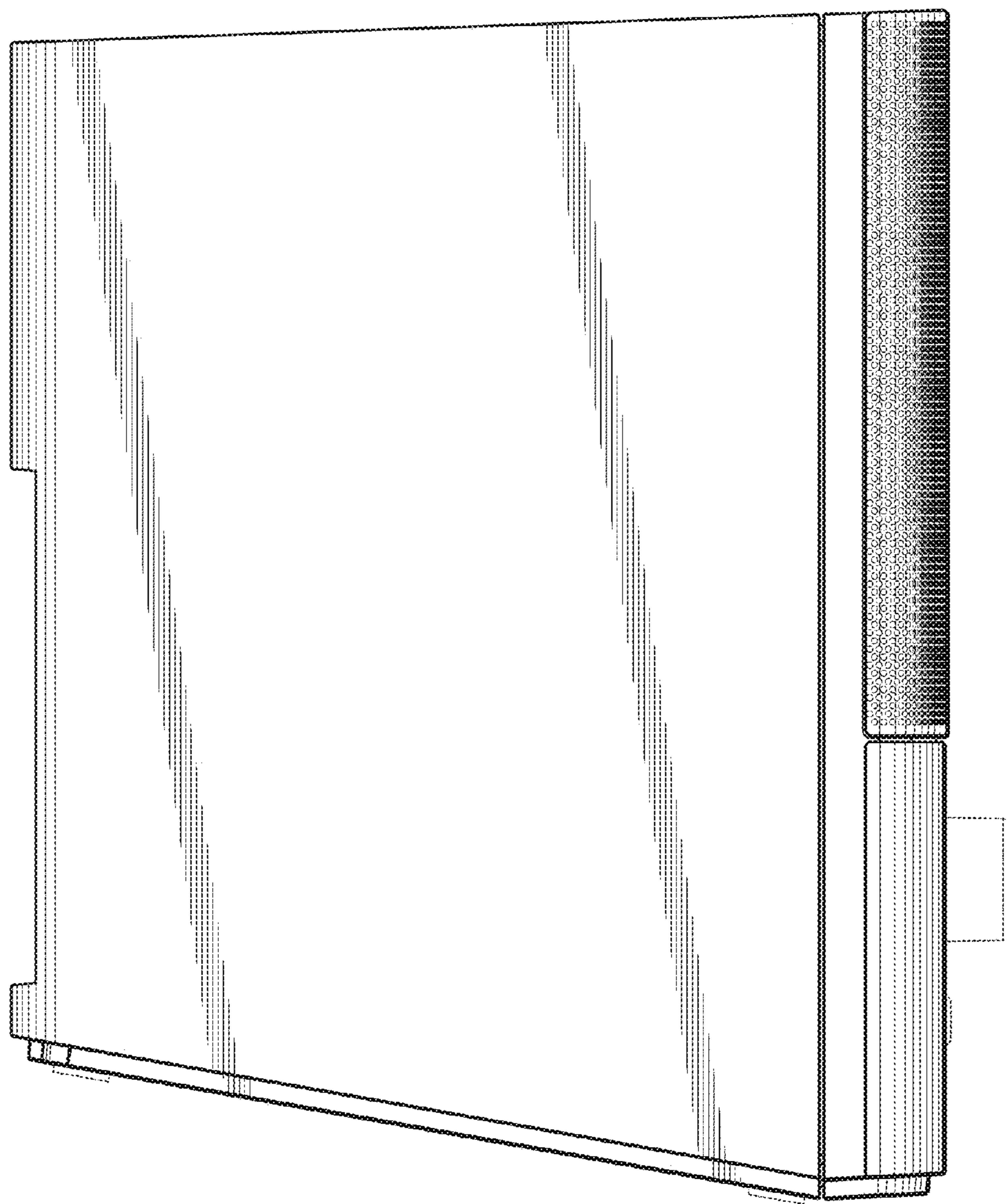

FIG. 21

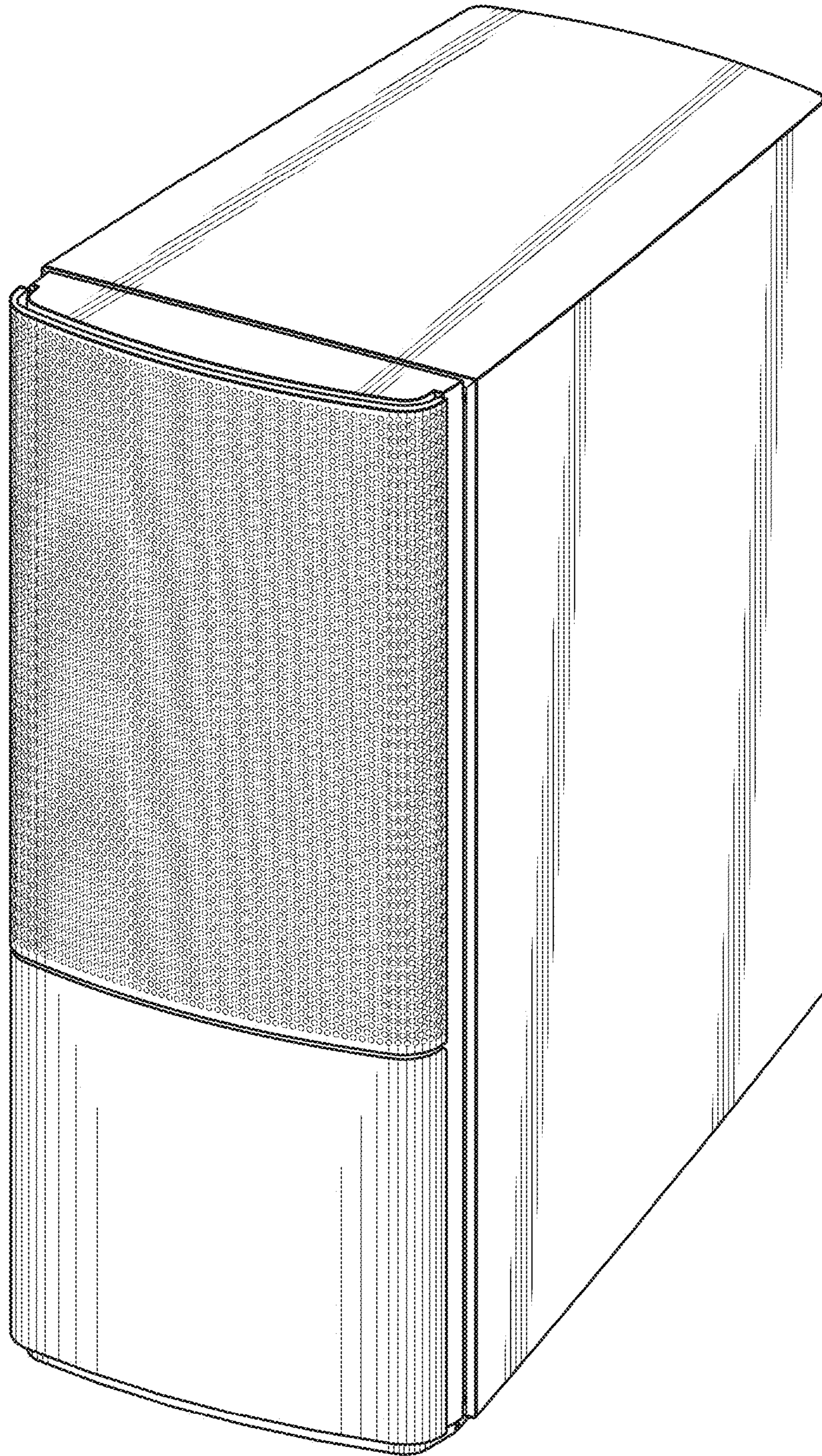

FIG. 22

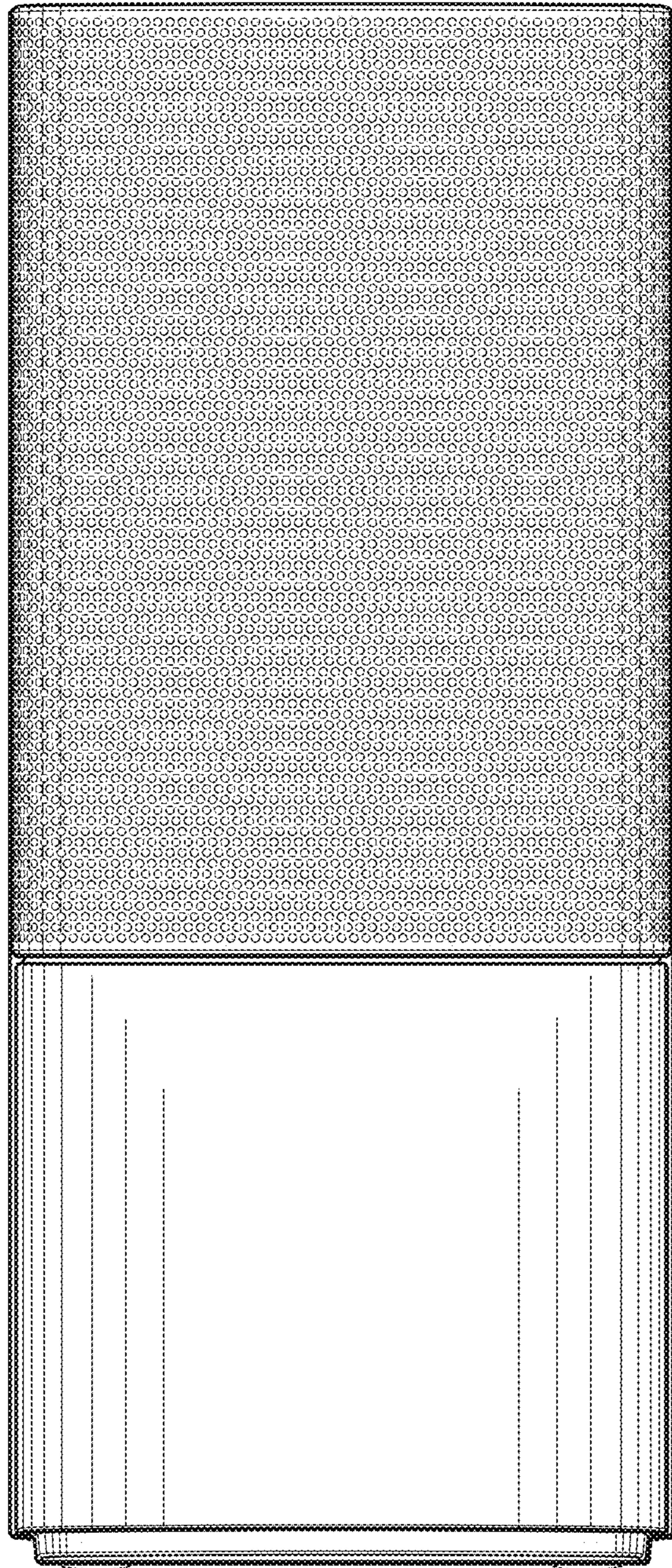

FIG. 23

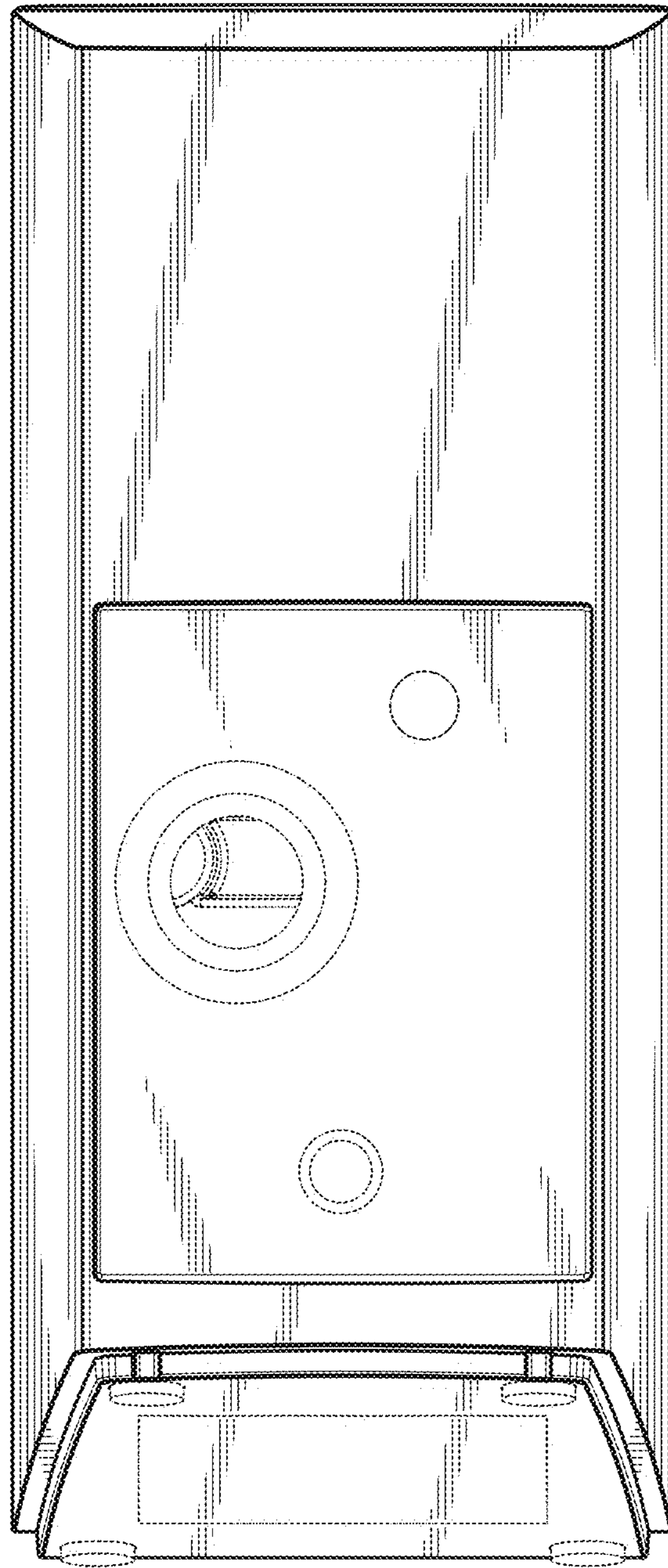

FIG. 24

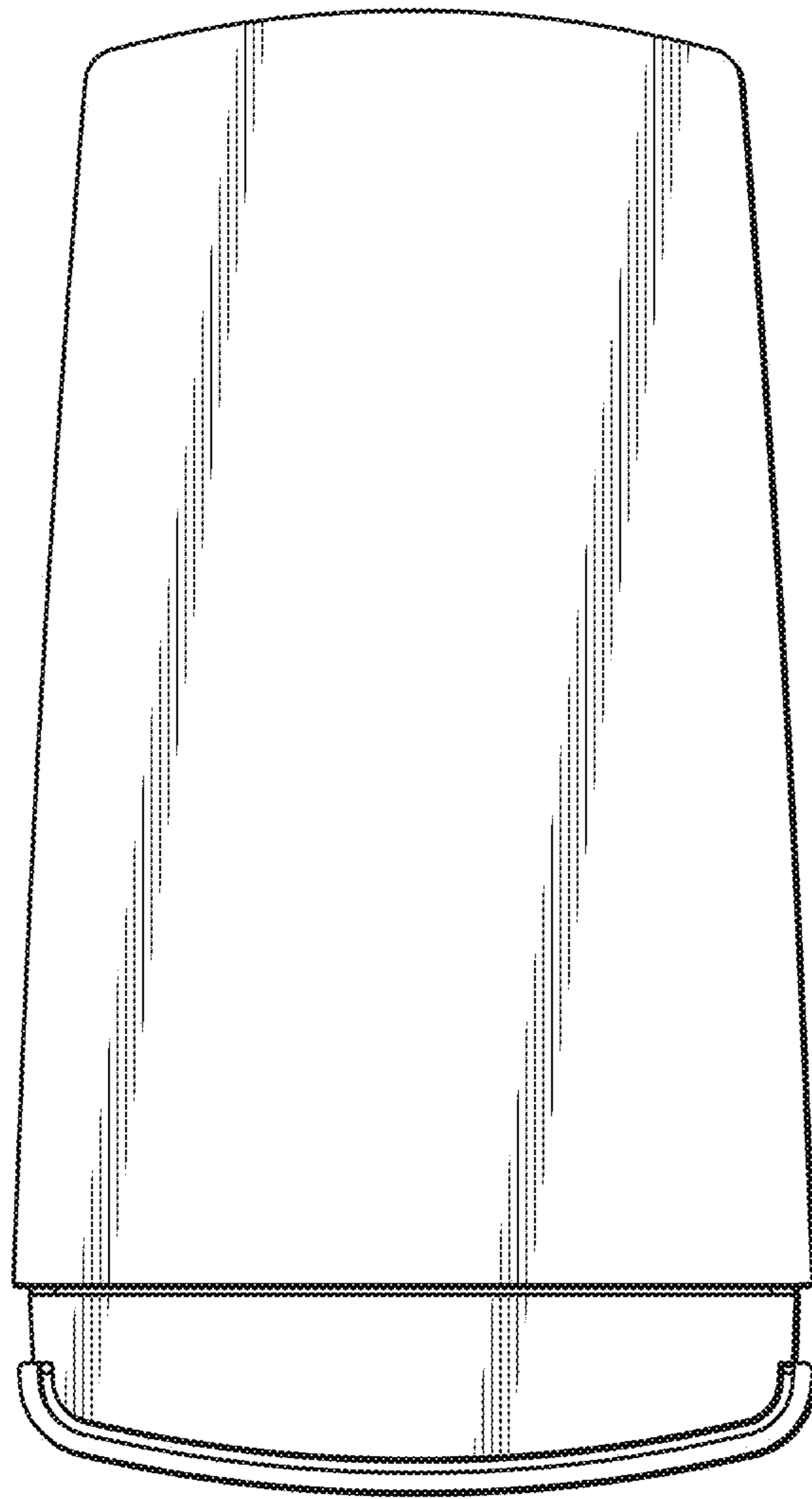

FIG. 25

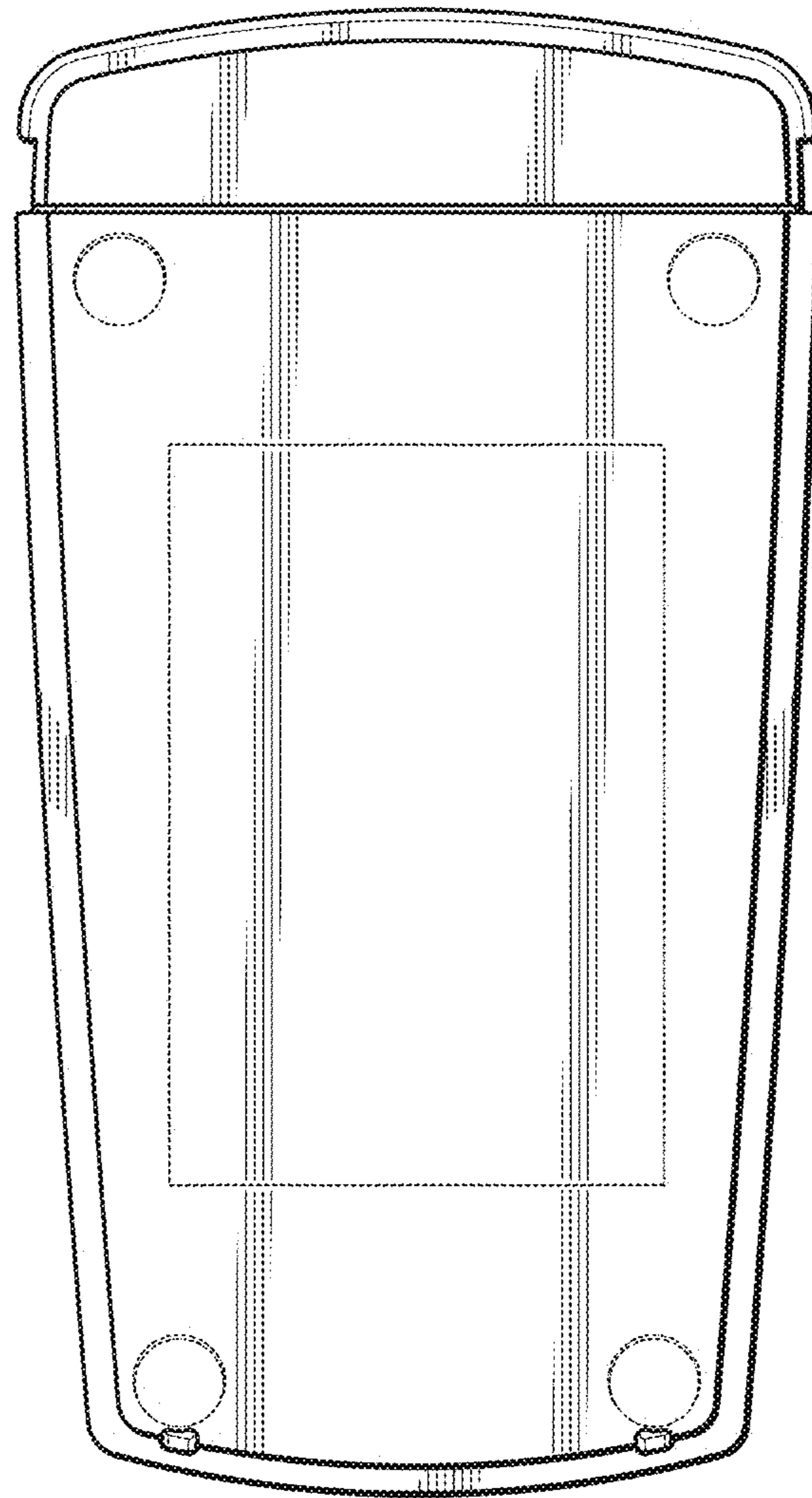

FIG. 26

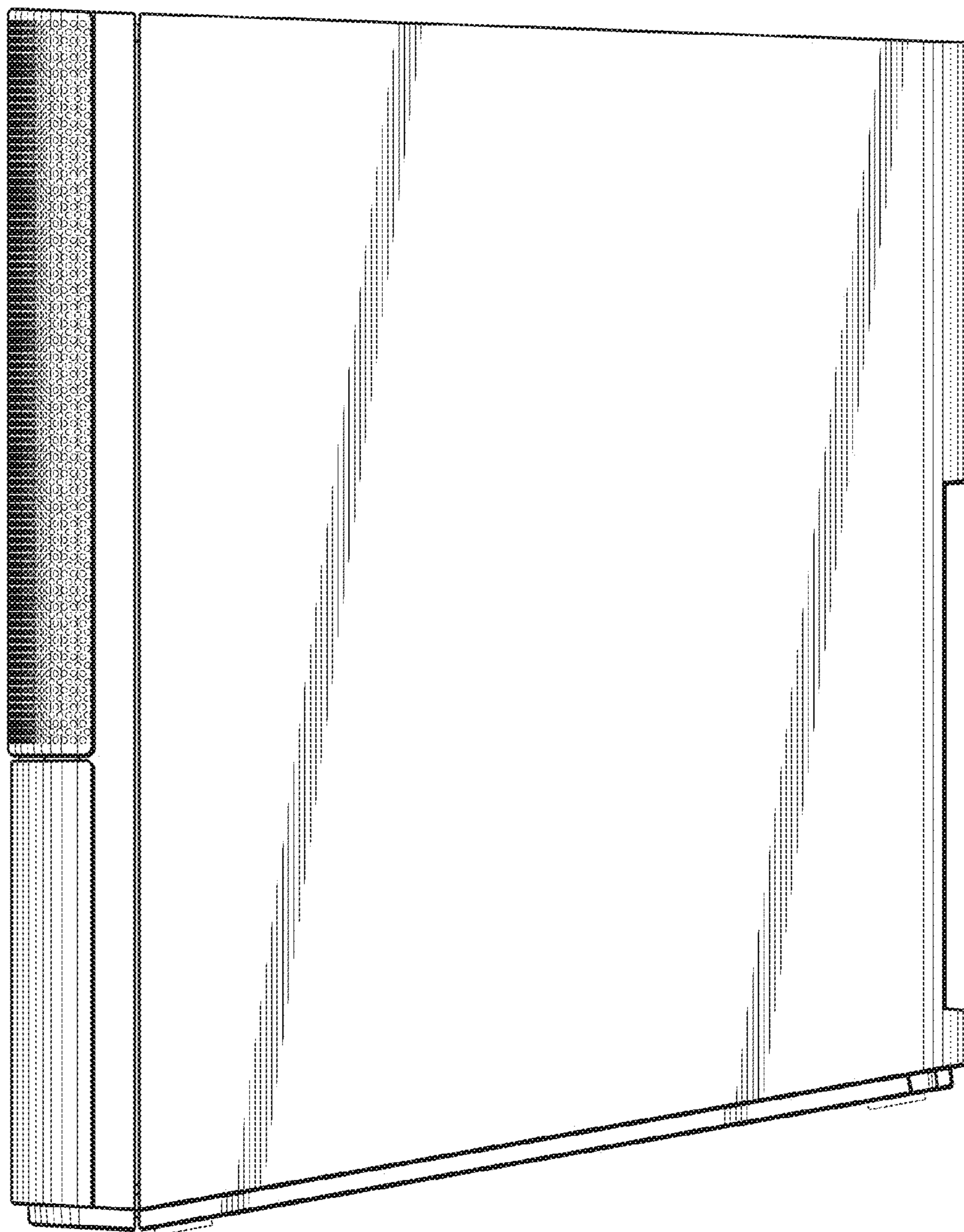

FIG. 27

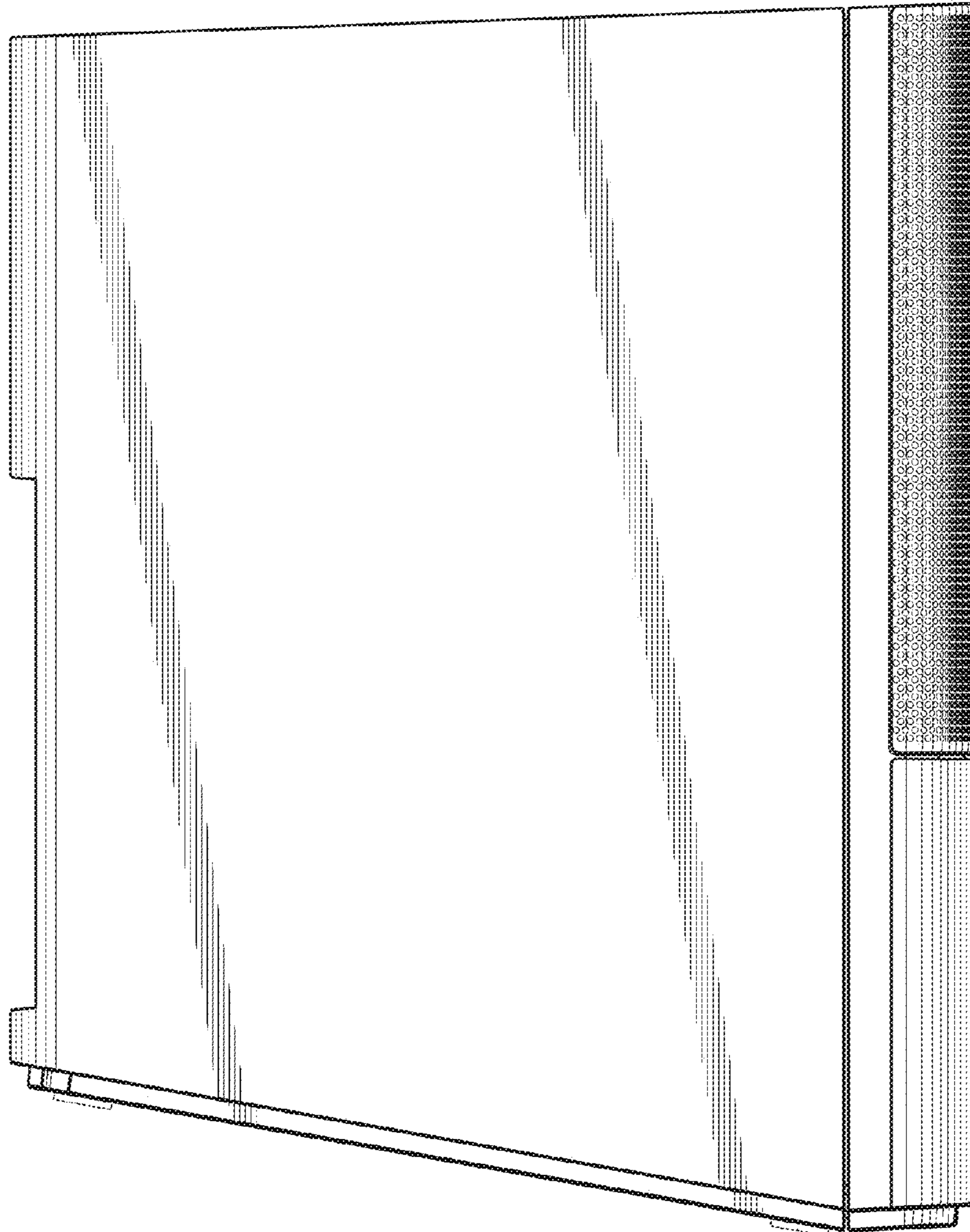

FIG. 28