



US00D695268S

(12) **United States Design Patent**  
**Holzer**

(10) **Patent No.:** **US D695,268 S**

(45) **Date of Patent:** **\*\* Dec. 10, 2013**

(54) **RECHARGEABLE DOCKING SPEAKER SYSTEM**

(75) Inventor: **Eric Holzer**, Piscataway, NJ (US)

(73) Assignee: **SDI Technologies, Inc.**, Rahway, NJ (US)

(\*\*) Term: **14 Years**

(21) Appl. No.: **29/413,438**

(22) Filed: **Feb. 15, 2012**

(51) **LOC (9) Cl.** ..... **14-01**

(52) **U.S. Cl.**  
USPC ..... **D14/209.1; D14/204**

(58) **Field of Classification Search**  
USPC ..... D14/204, 204.1, 210–216, 172;  
181/143, 144, 147, 148, 150–153, 157,  
181/198, 199; 381/300–306, 332, 333, 336,  
381/345, 361–364  
See application file for complete search history.

(56) **References Cited**

**U.S. PATENT DOCUMENTS**

D611,450 S *	3/2010	Miyazaki	.....	D14/209.1
7,689,197 B2 *	3/2010	Laude et al.	.....	455/344
D656,919 S *	4/2012	Skurdal	.....	D14/171
D658,151 S *	4/2012	Joseph	.....	D14/171
8,180,095 B2 *	5/2012	Zhang	.....	381/387
D676,418 S *	2/2013	Suzuki	.....	D14/209.1
D677,244 S *	3/2013	Funayama	.....	D14/209.1

\* cited by examiner

*Primary Examiner* — Prabhakar Deshmukh

(74) *Attorney, Agent, or Firm* — Ostrolenk Faber LLP

(57) **CLAIM**

The ornamental design for a rechargeable docking speaker system, as shown and described.

**DESCRIPTION**

FIG. 1 is a front, top, right side, perspective view of a rechargeable docking speaker system showing my new design in a first condition;

FIG. 2 is a front view thereof;

FIG. 3 is a rear view thereof;

FIG. 4 is a top view thereof;

FIG. 5 is a bottom view thereof;

FIG. 6 is a side view thereof, at an enlarged scale, the opposite side view being a mirror image;

FIG. 7 is a cross-sectional view thereof along line 7-7 in FIG. 2 at an enlarged scale;

FIG. 8 is a cross-sectional view thereof along line 8-8 in FIG. 5;

FIG. 9 is a cross-sectional view thereof along line 9-9 in FIG. 4;

FIG. 10 is a cross-sectional view thereof along line 10-10 in FIG. 2;

FIG. 11 is a front, top, right side, perspective view thereof in a second condition;

FIG. 12 is a front view thereof;

FIG. 13 is a rear view thereof;

FIG. 14 is a top view thereof;

FIG. 15 is a bottom view thereof;

FIG. 16 is a side view thereof at an enlarged scale, the opposite side view being a mirror image;

FIG. 17 is a cross-sectional view thereof at an enlarged scale along line 17-17 in FIG. 12;

FIG. 18 is a cross-sectional view thereof at an enlarged scale along line 18-18 in FIG. 15;

FIG. 19 is a cross sectional view thereof along line 19-19 in FIG. 13; and,

FIG. 20 is a bottom, side, perspective view thereof.

The broken lines in the drawings illustrate environmental material that forms no part of the claimed design.

**1 Claim, 20 Drawing Sheets**

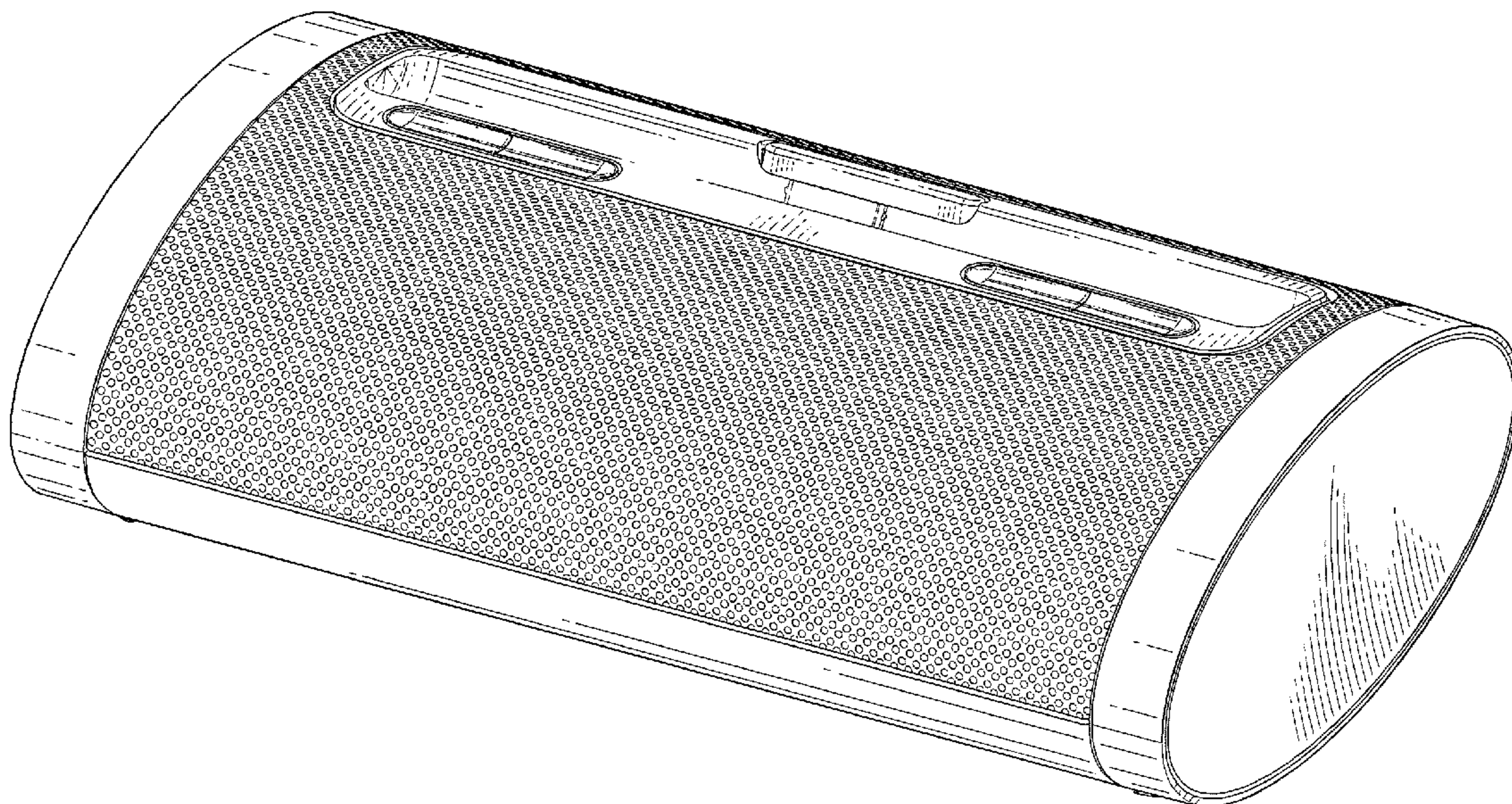



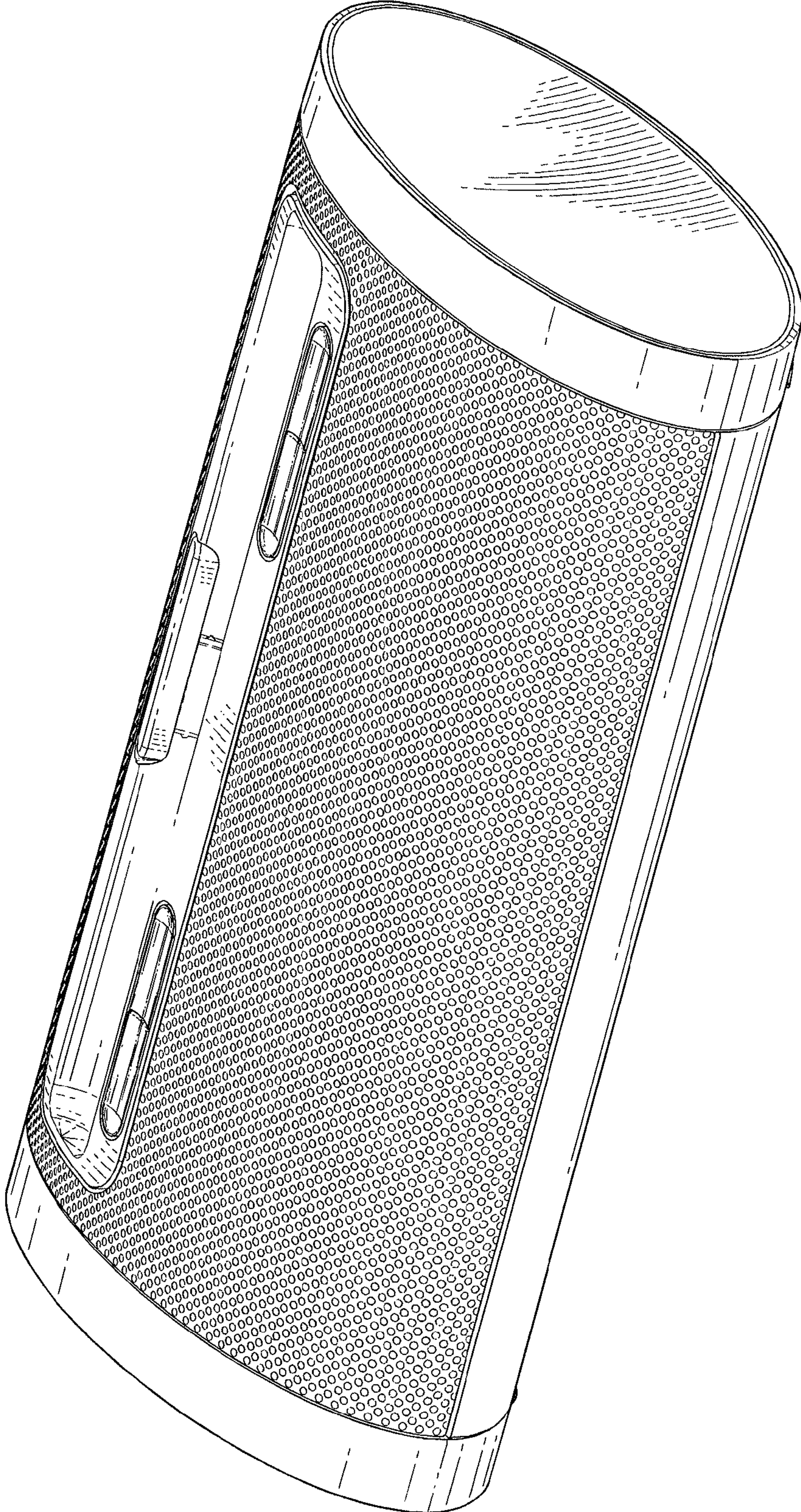

FIG.1



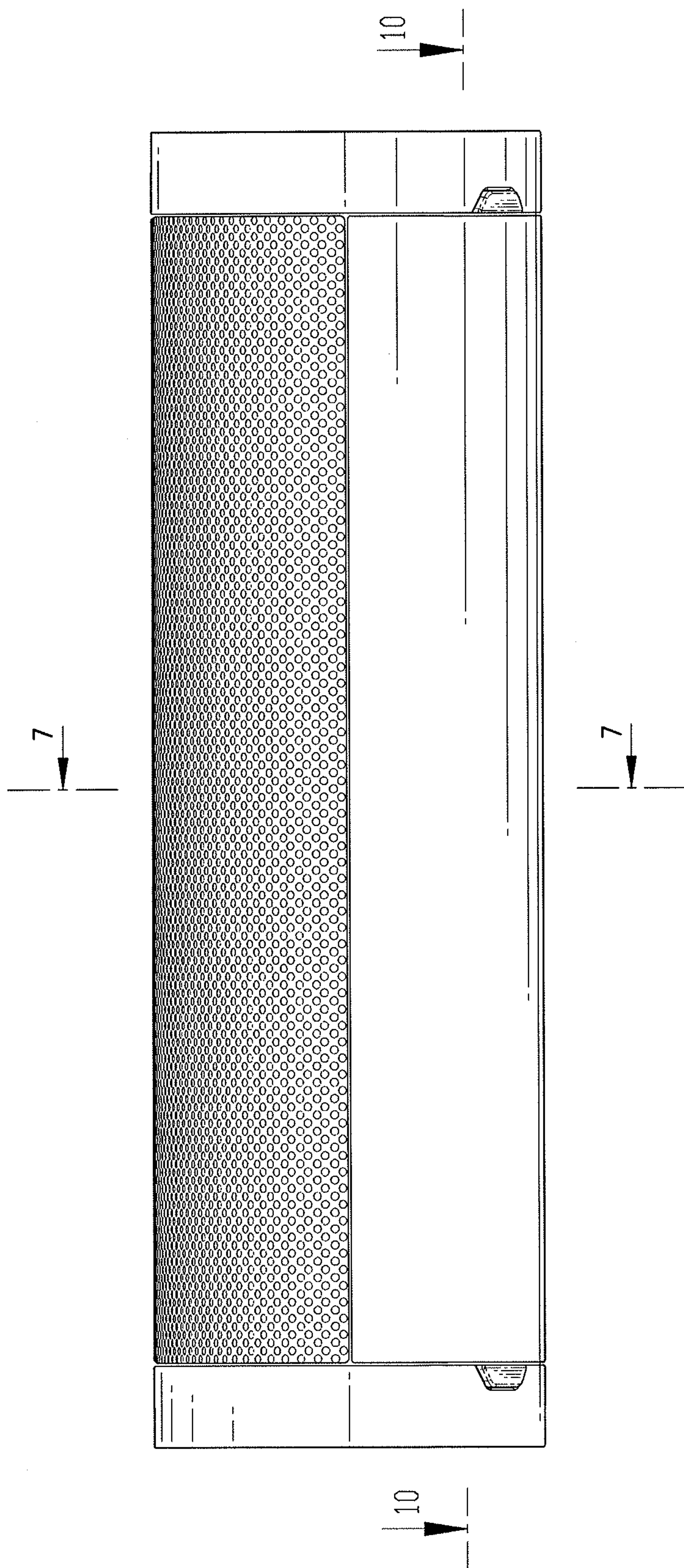

FIG. 2

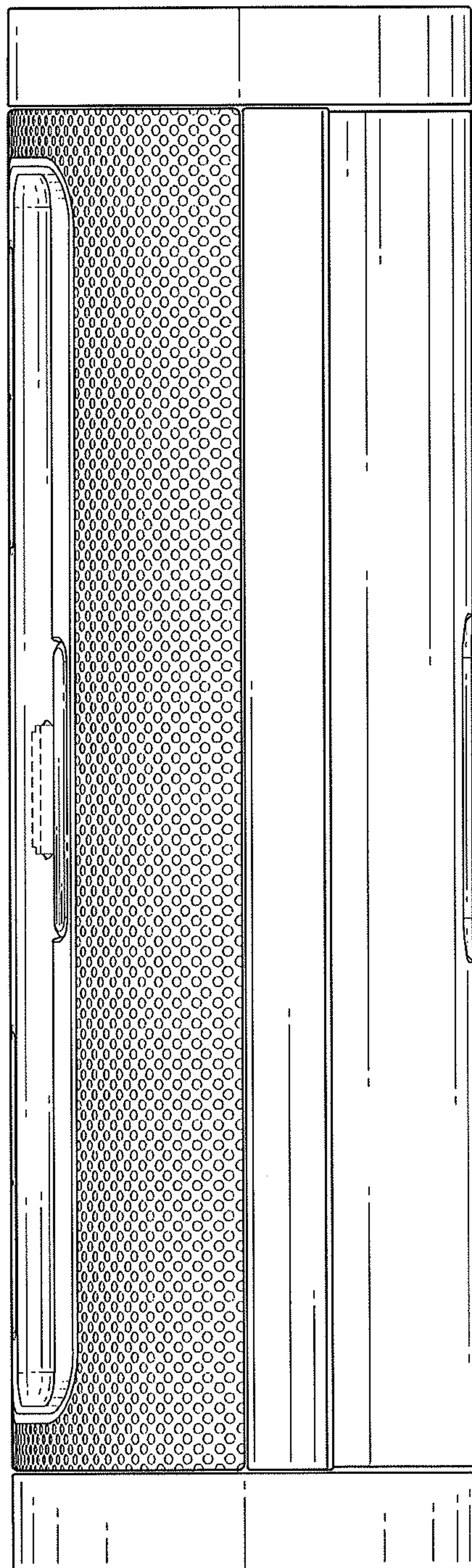

FIG. 3



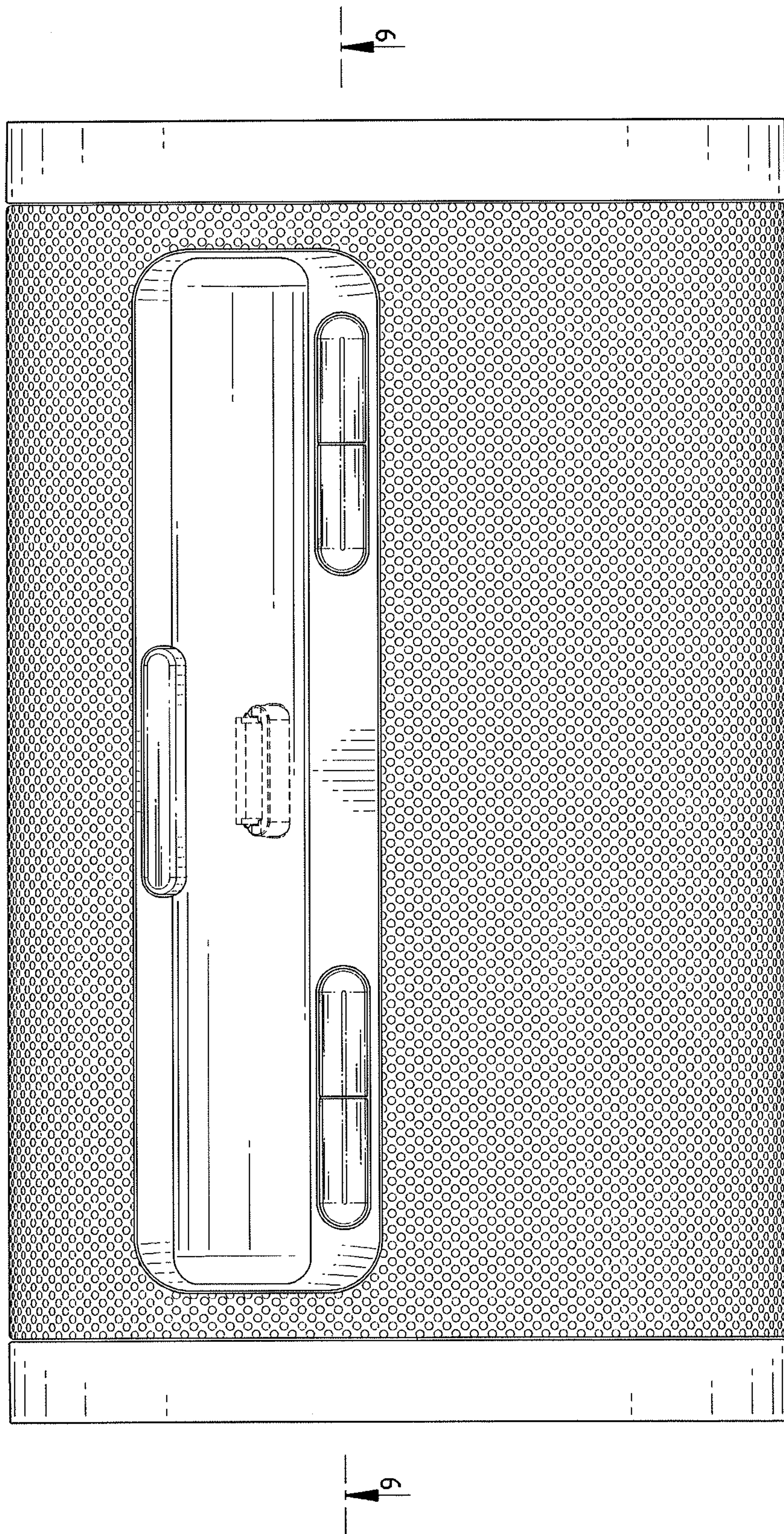

FIG. 4

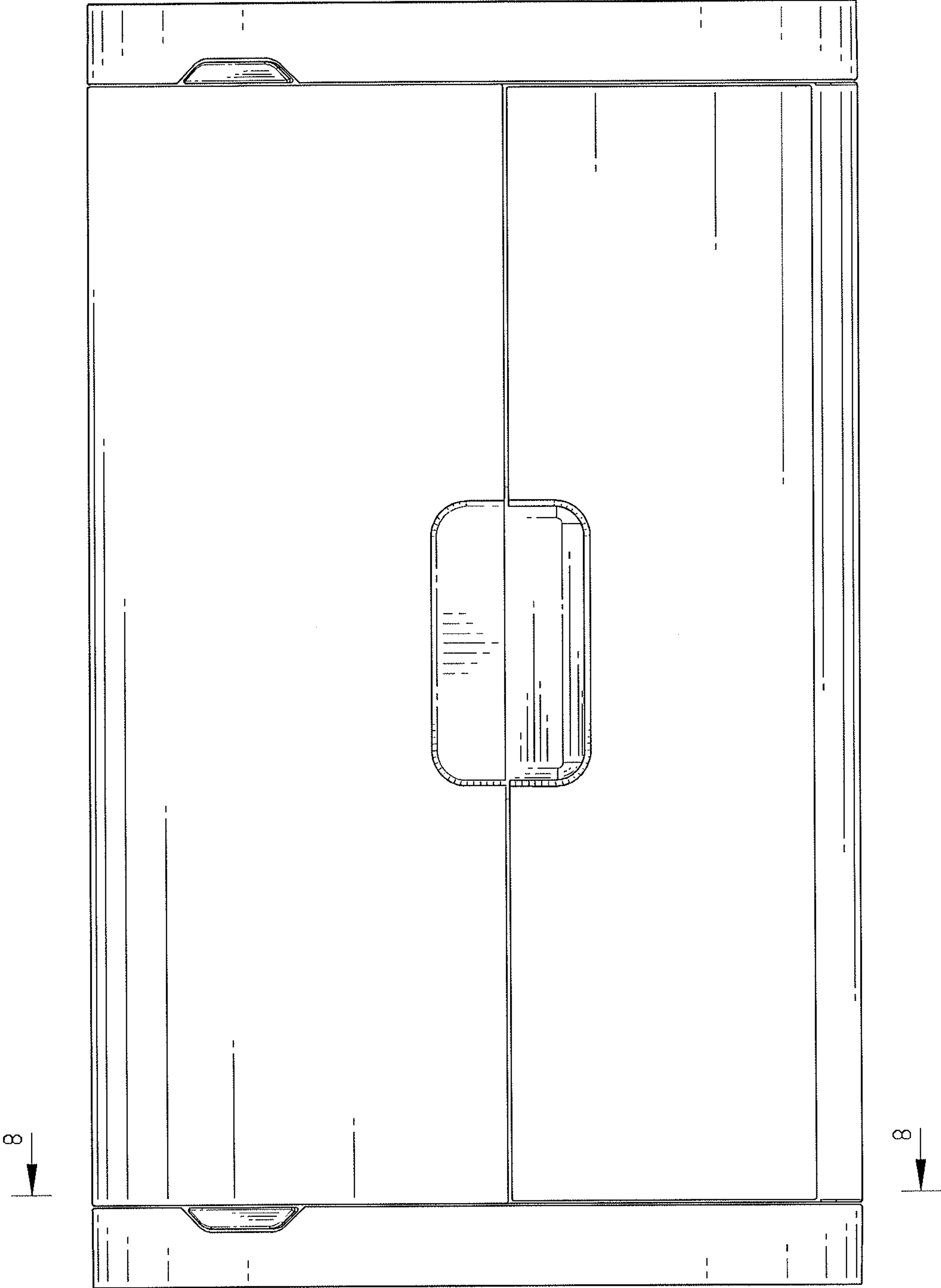

FIG. 5



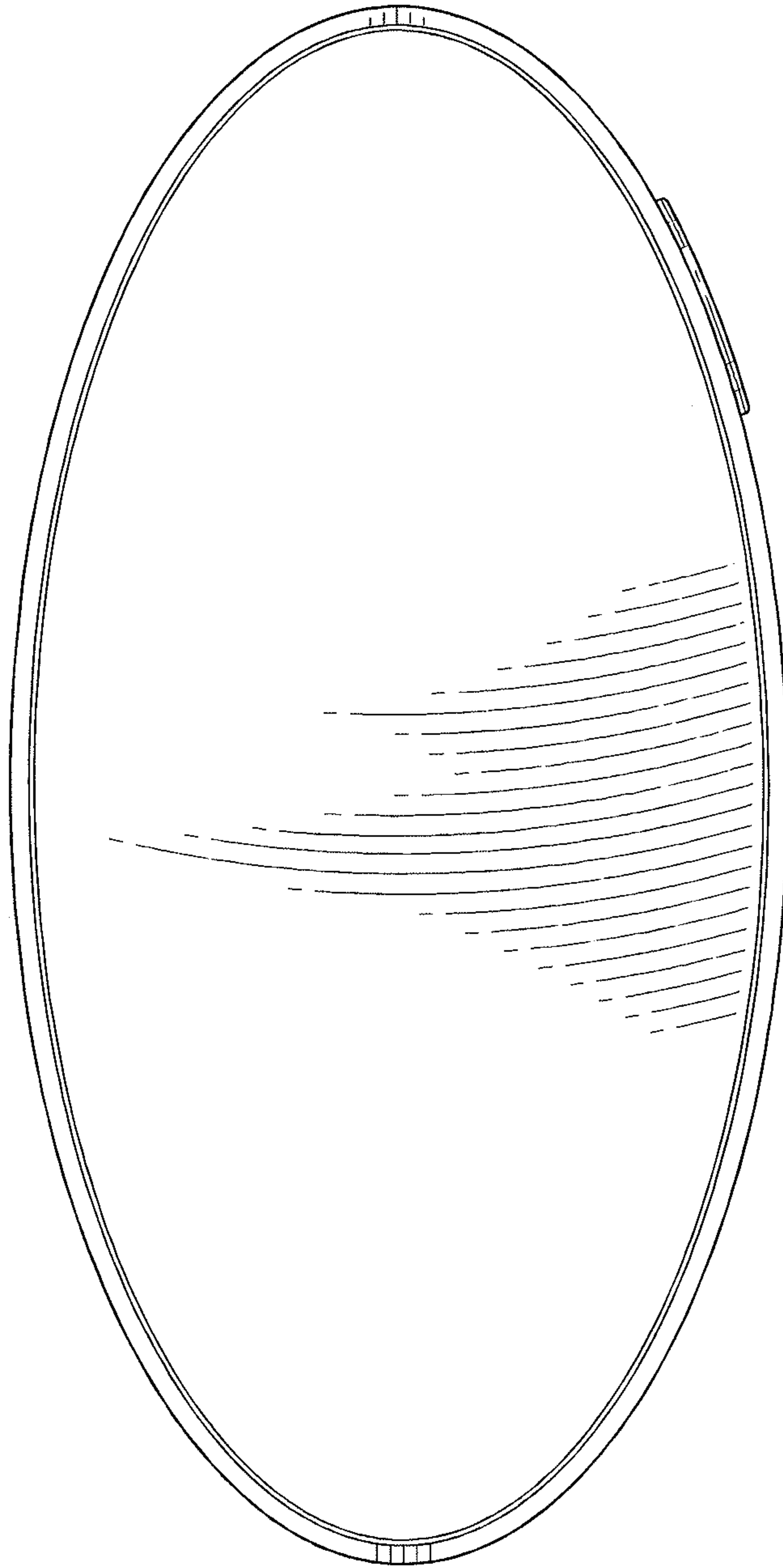

FIG. 6

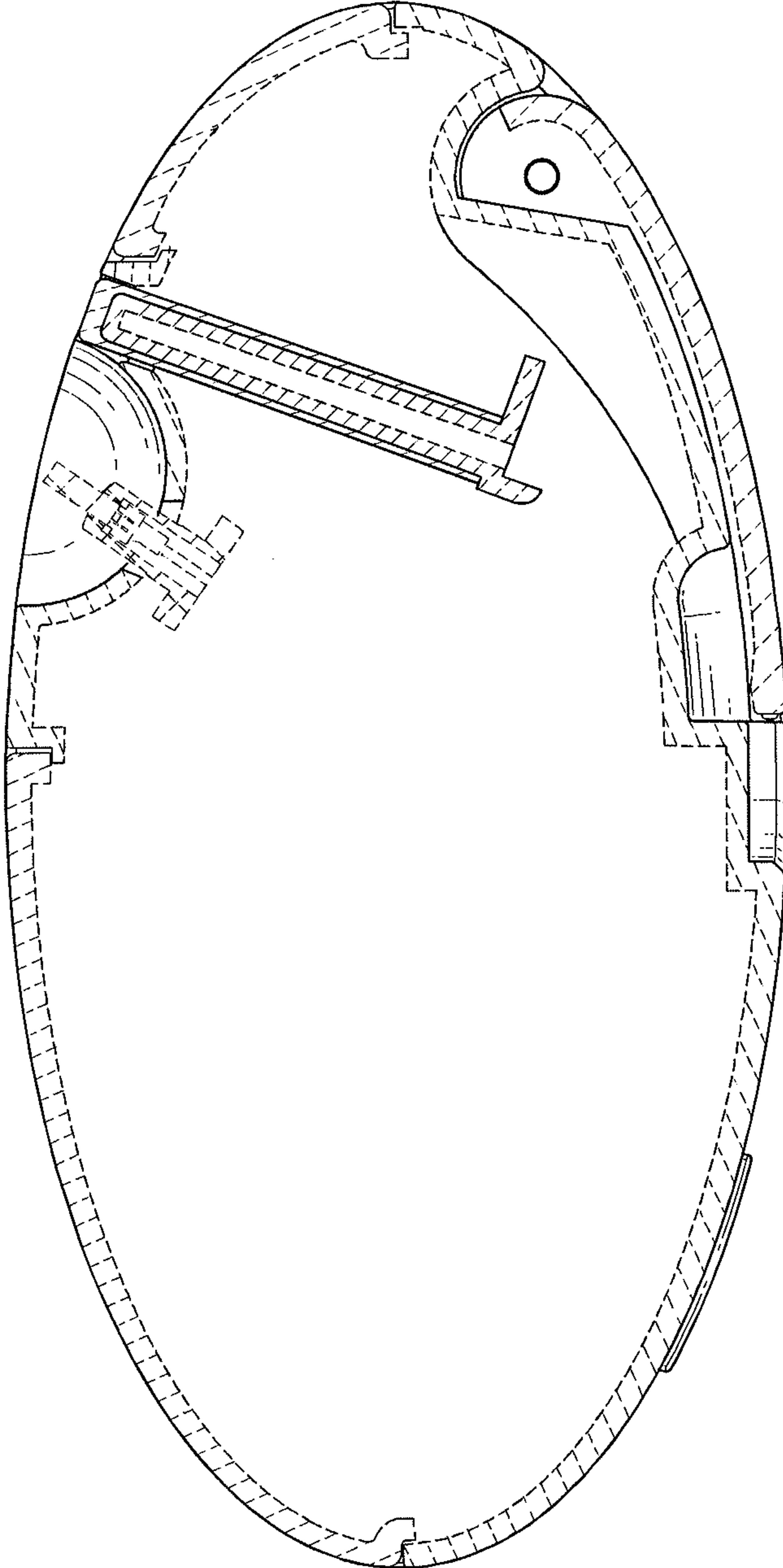

FIG. 7



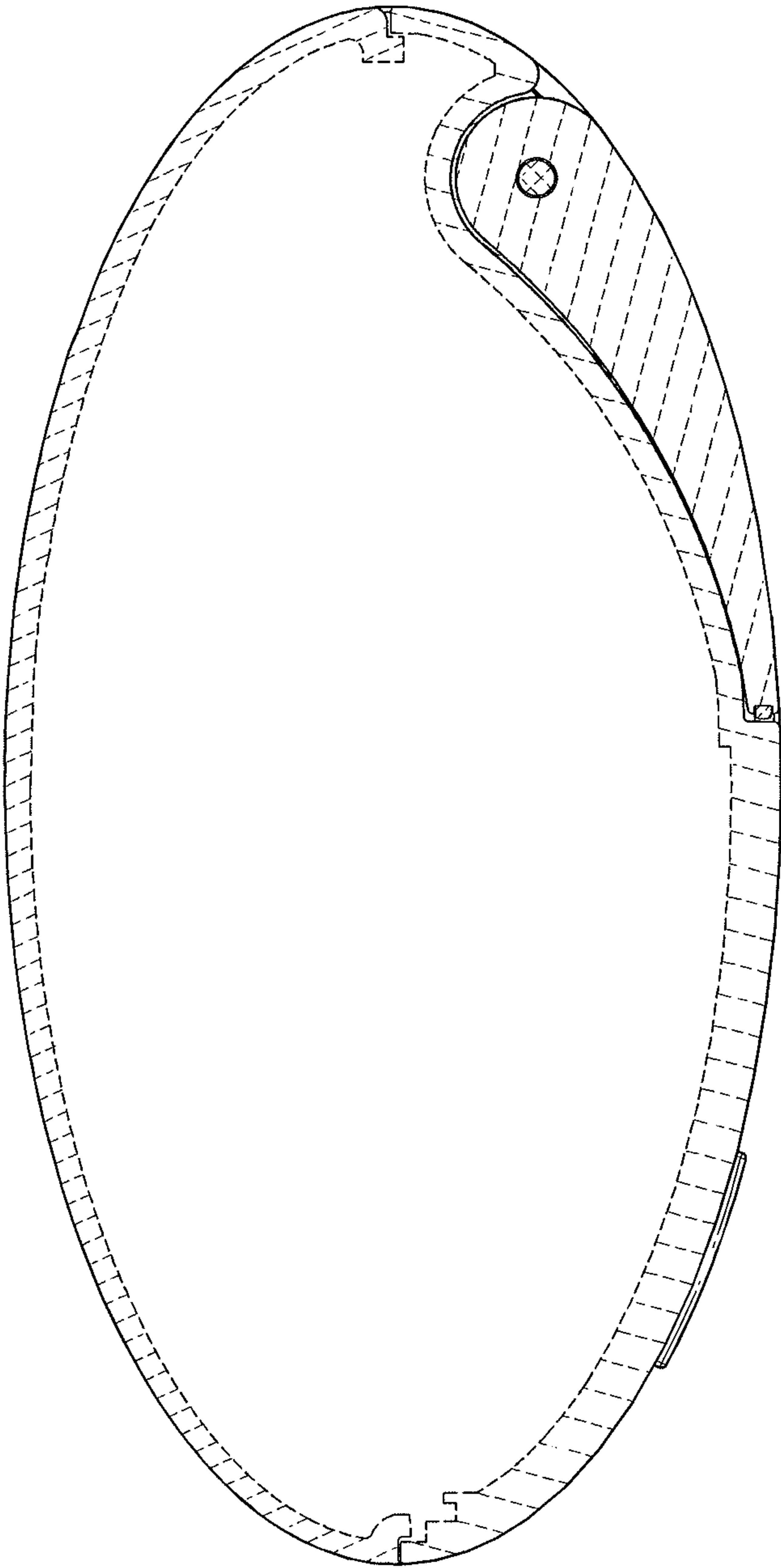

FIG. 8

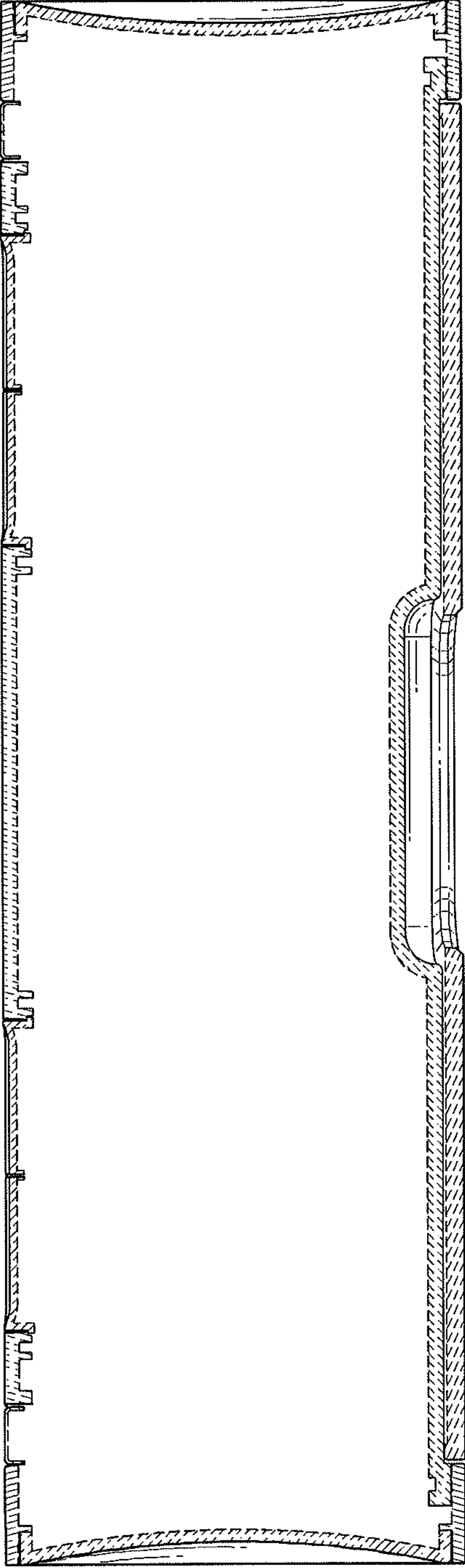

FIG. 9



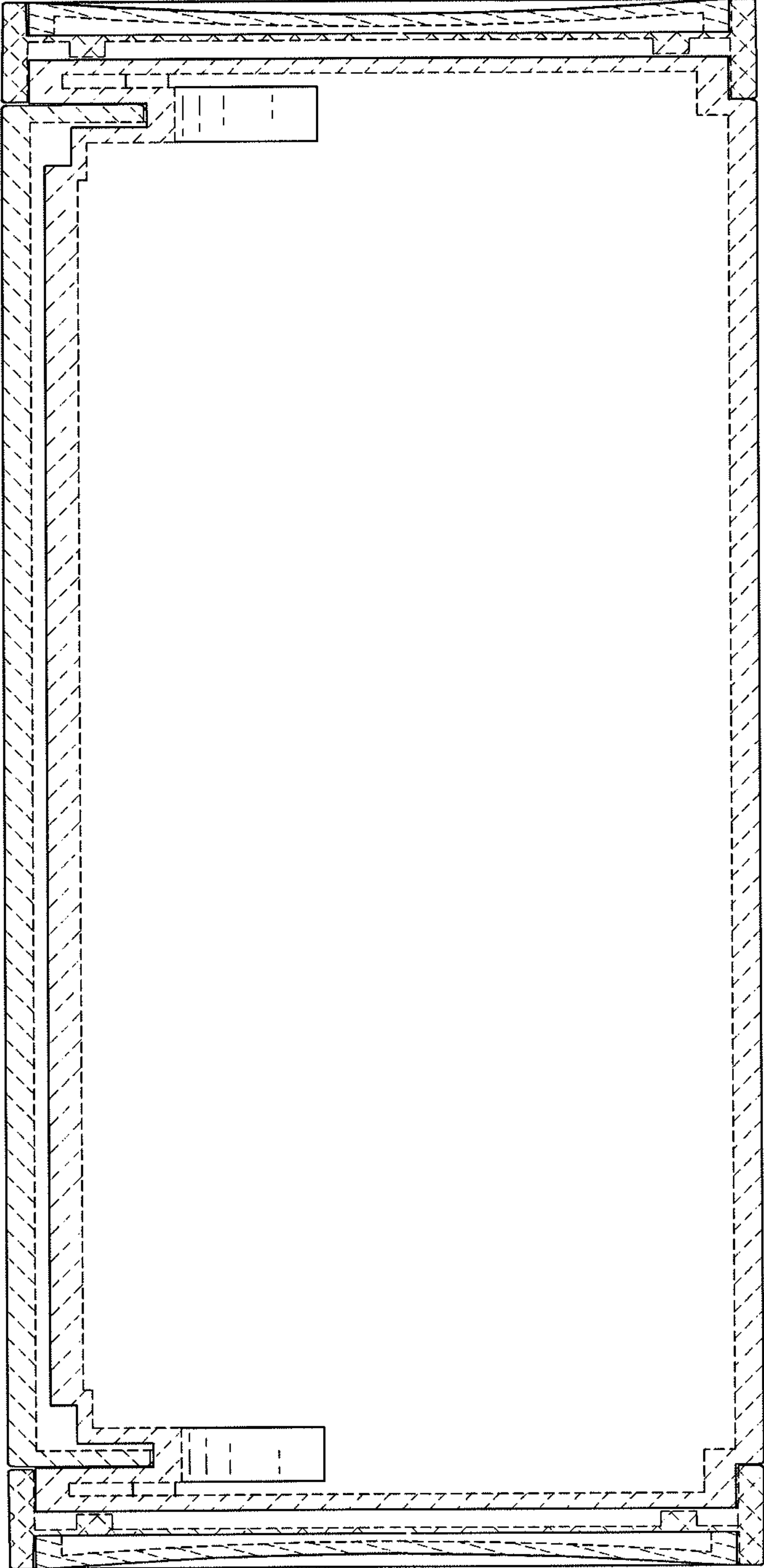

FIG. 10

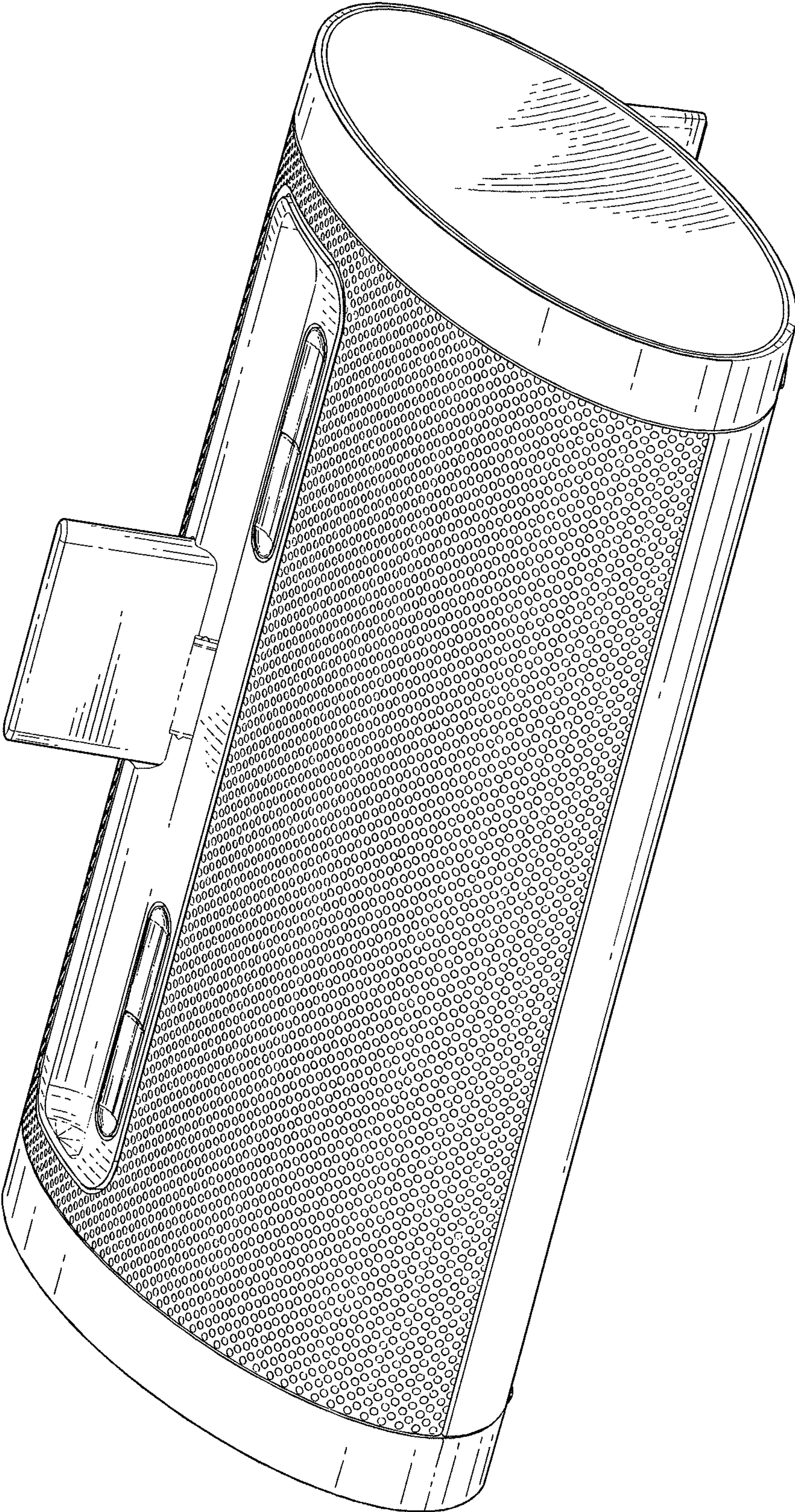

FIG. 11



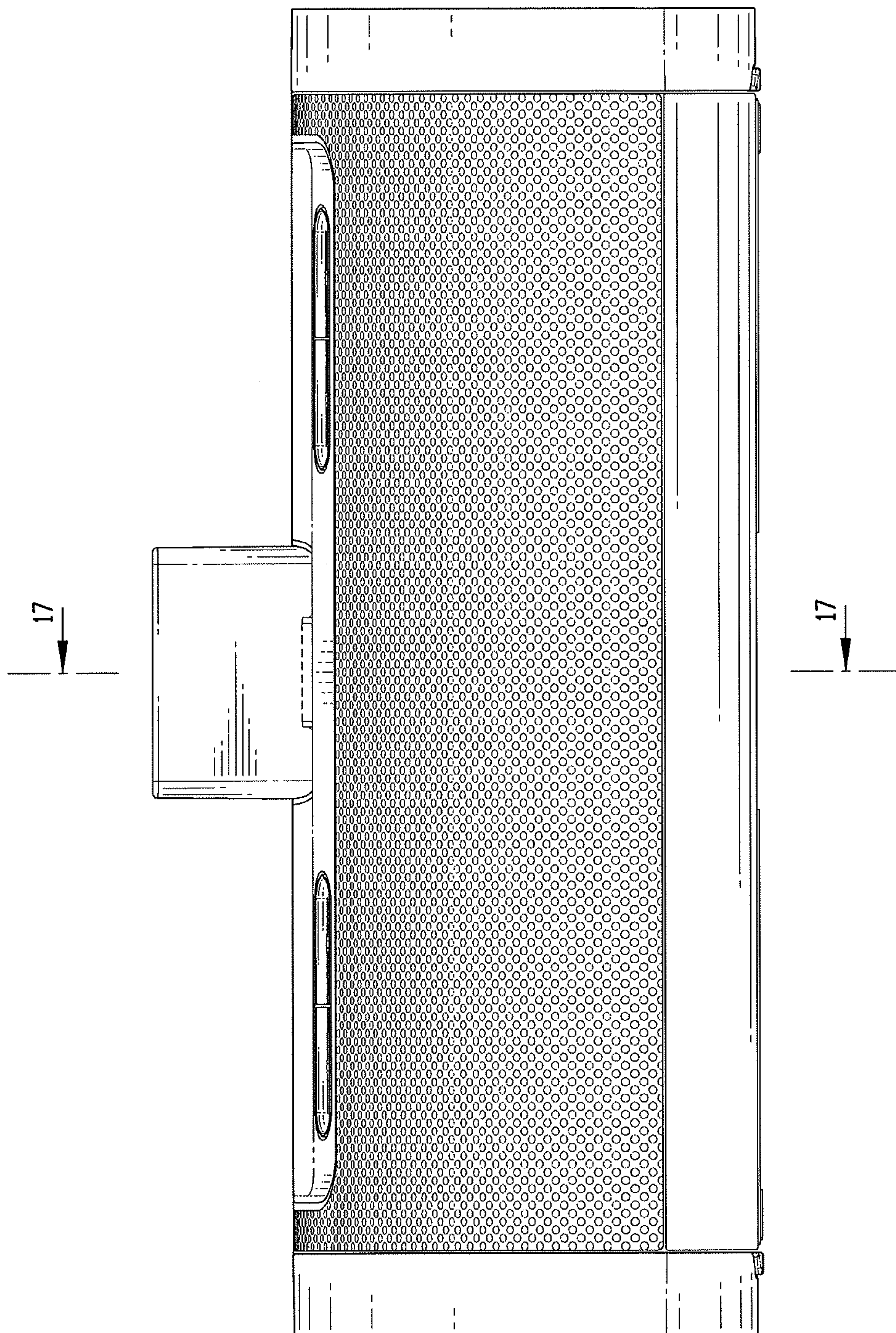

FIG. 12

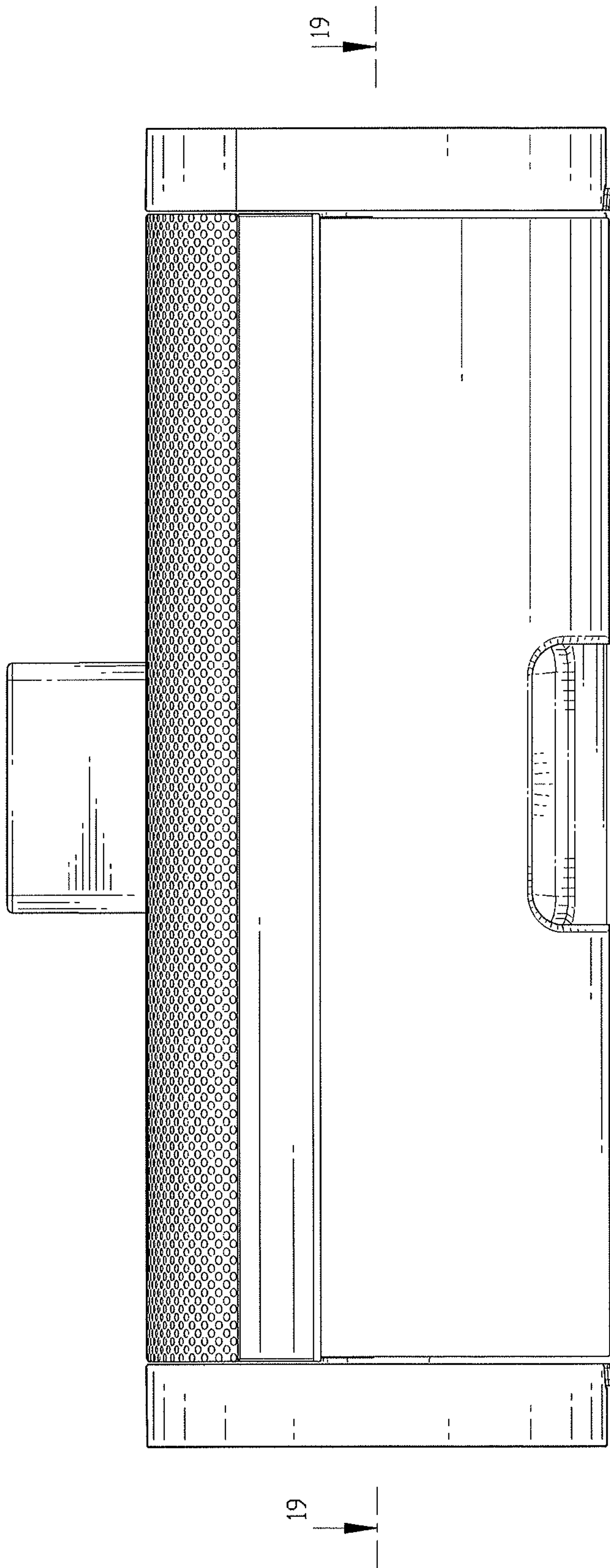

FIG. 13



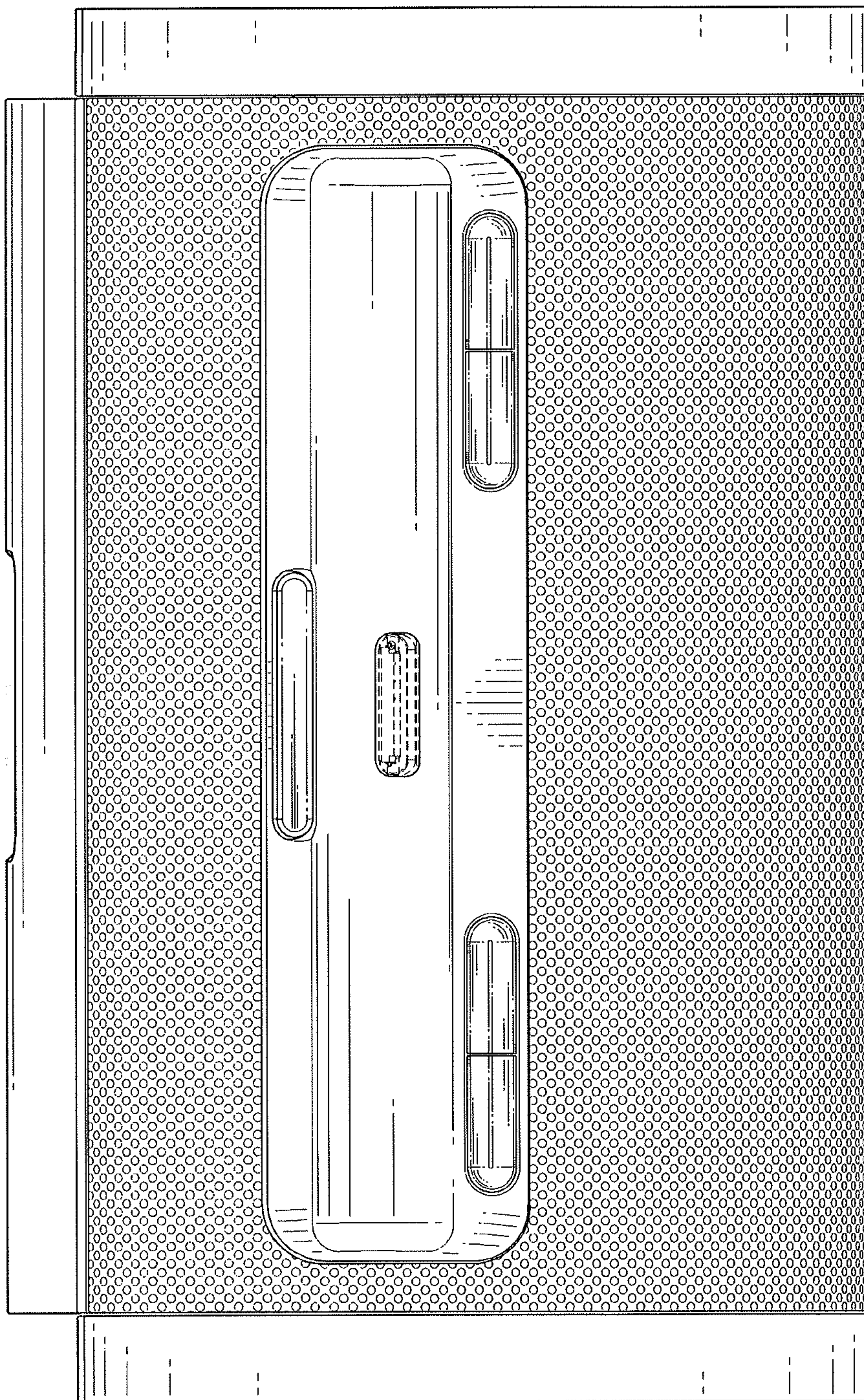

FIG. 14

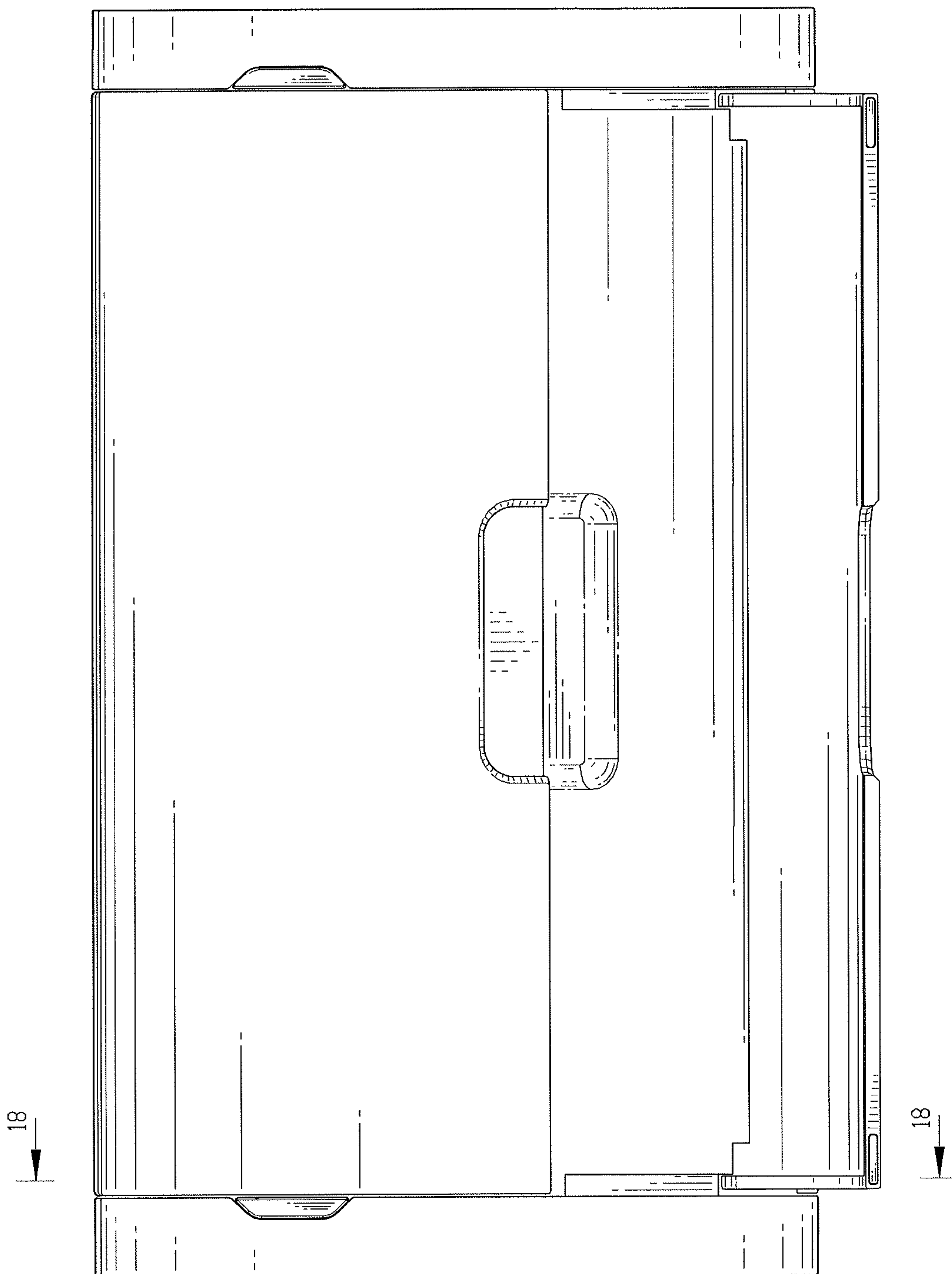

FIG. 15



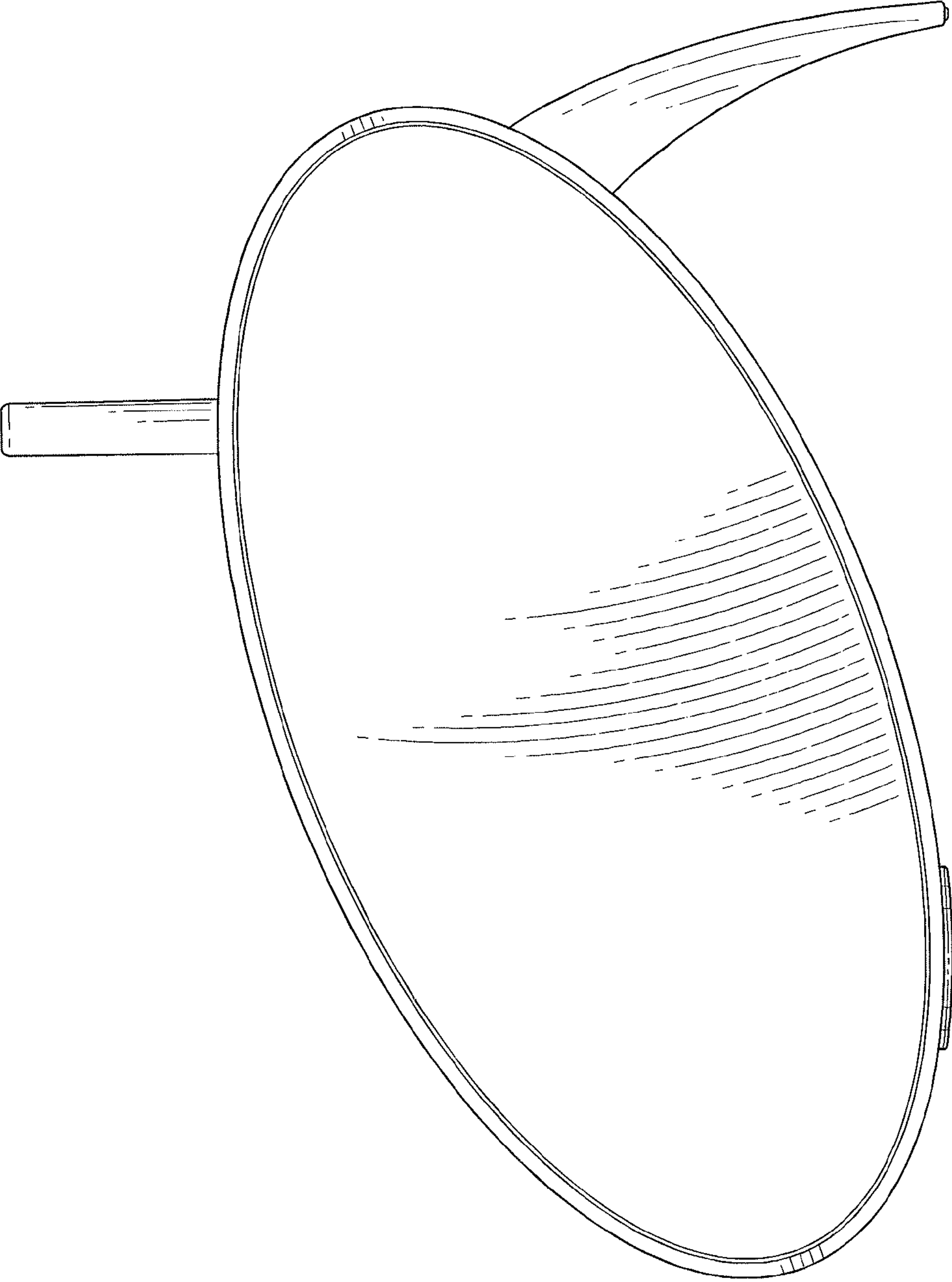

FIG. 16

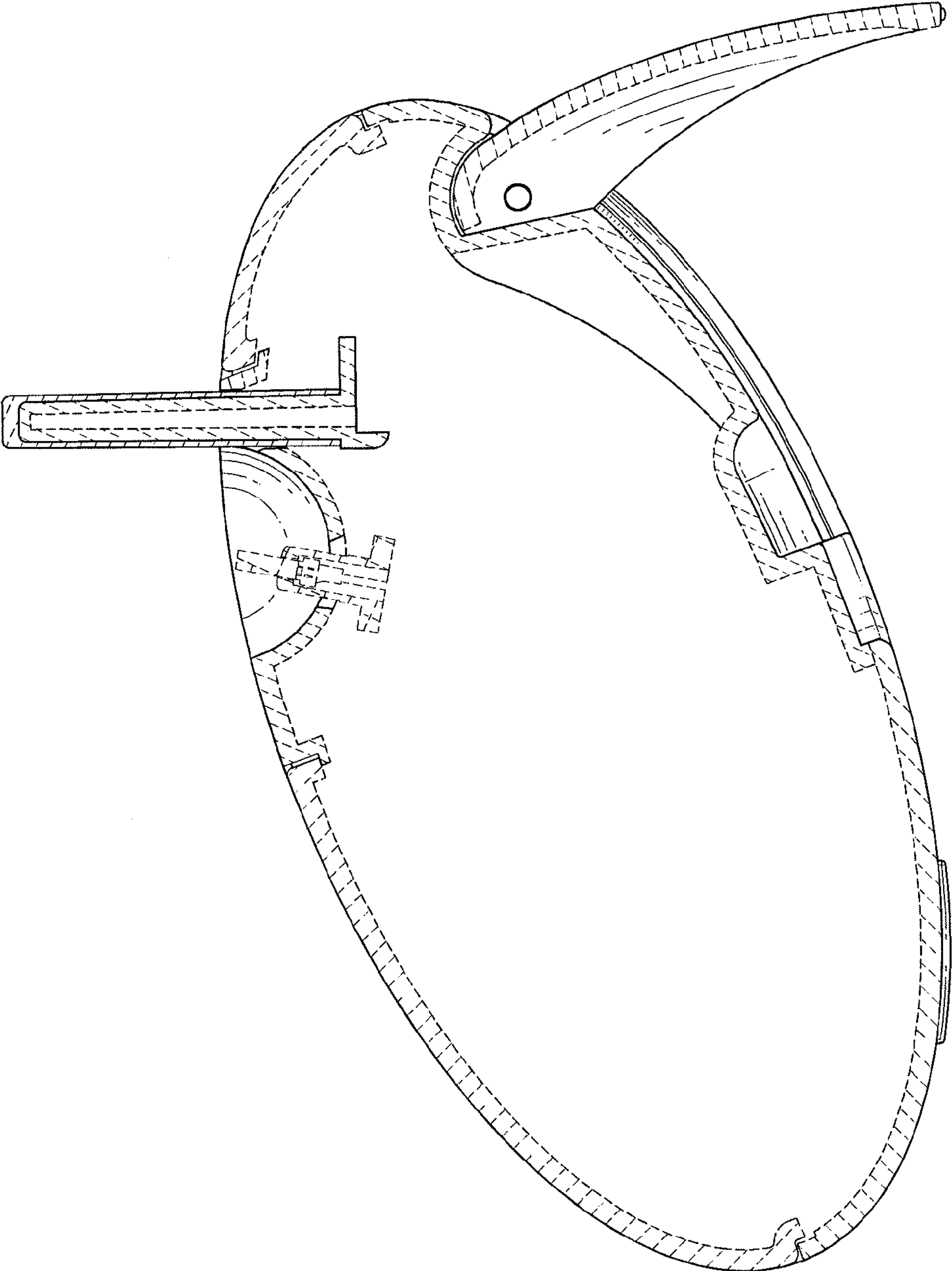

FIG. 17



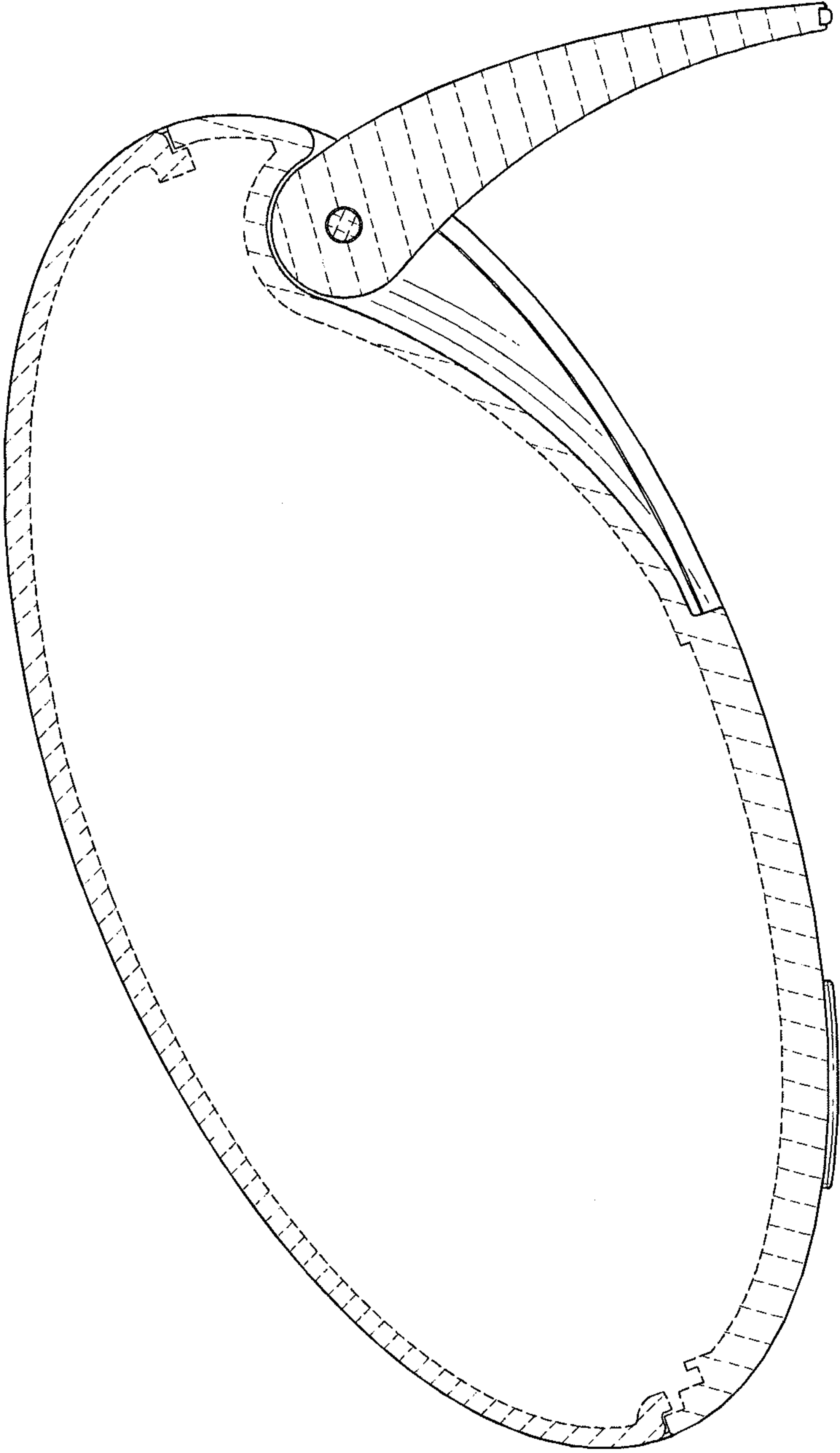

FIG. 18

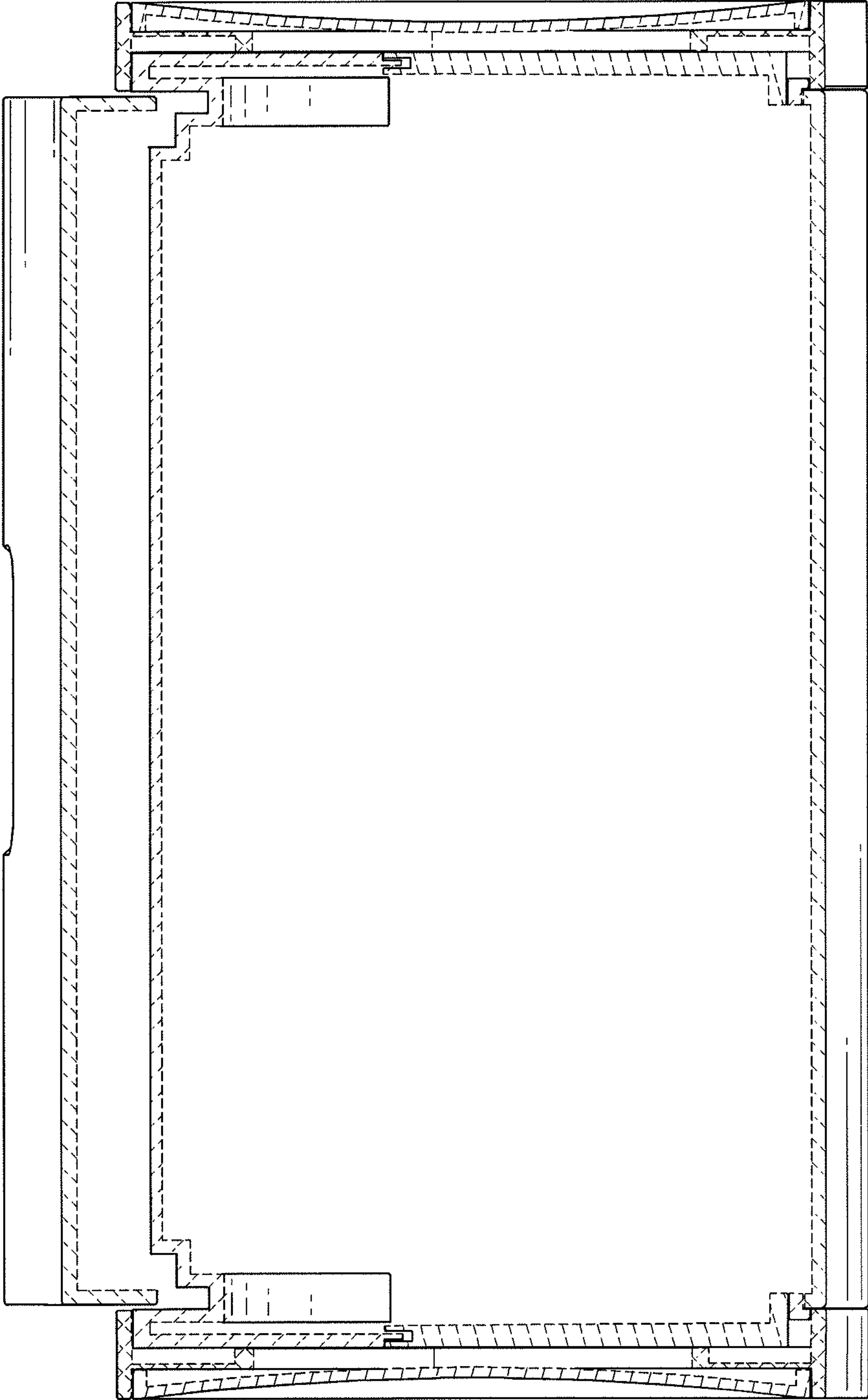

FIG. 19



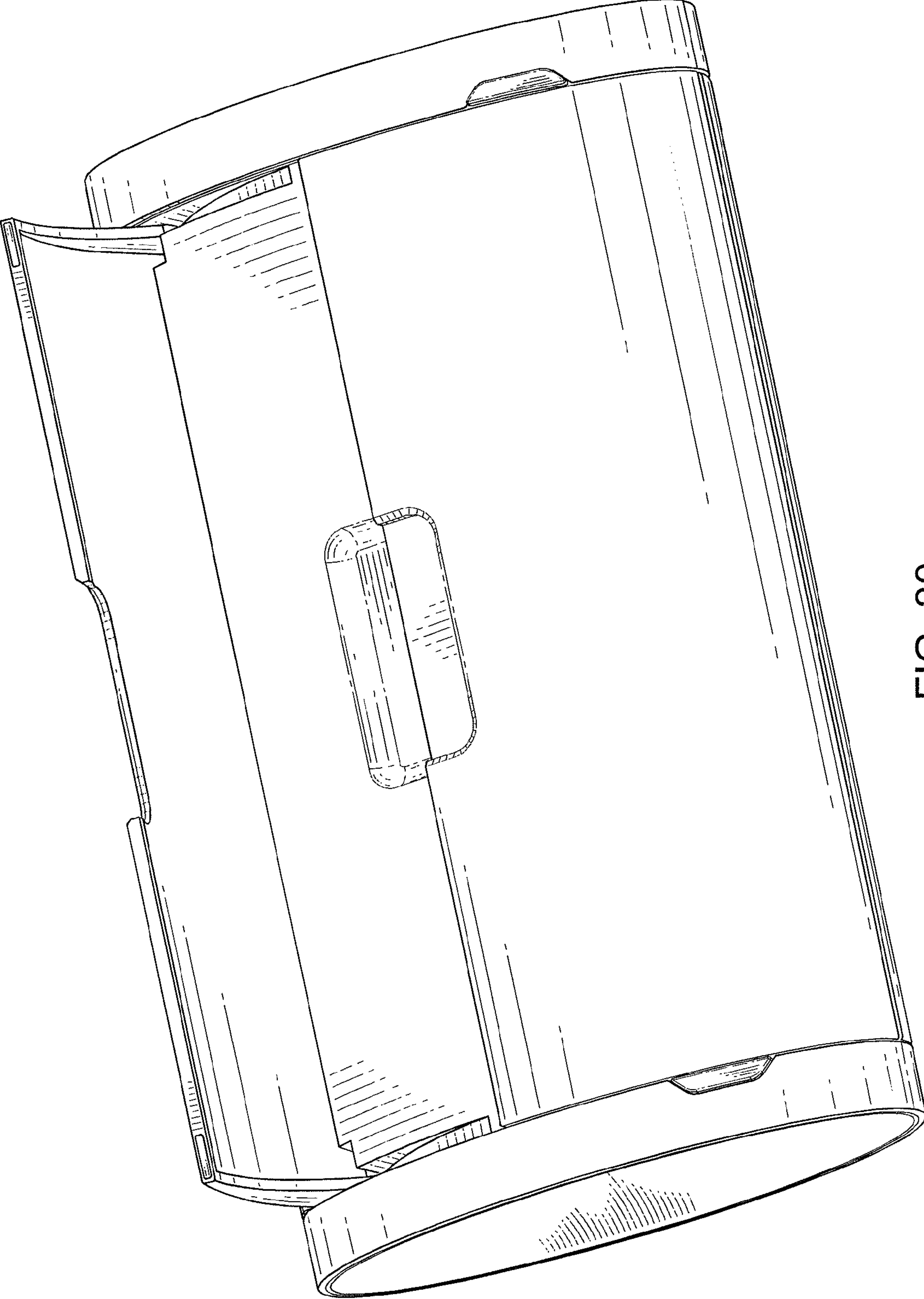

FIG. 20