

US00D695250S

(12) **United States Design Patent**
Kim et al.

(10) **Patent No.:** **US D695,250 S**

(45) **Date of Patent:** **** *Dec. 10, 2013**

(54) **MOBILE TERMINAL**

(75) Inventors: **Jin-Soo Kim**, Yongin-si (KR);
Jung-Min Yeo, Seoul (KR)

(73) Assignee: **Samsung Electronics Co., Ltd.**,
Suwon-si (KR)

(*) Notice: This patent is subject to a terminal disclaimer.

(**) Term: **14 Years**

(21) Appl. No.: **29/419,138**

(22) Filed: **Apr. 25, 2012**

(30) **Foreign Application Priority Data**

Nov. 22, 2011 (KR) 30-2011-0049144

(51) **LOC (9) Cl.** **14-03**

(52) **U.S. Cl.**
USPC **D14/138 G; D14/341**

(58) **Field of Classification Search**
USPC D14/138 R, 138 AD, 138 AC, 138 C,
D14/138 G, 191, 203.1–203.8, 496, 138 AA,
D14/138 AB, 137, 147, 218, 341–347,
D14/247–248; D10/65, 78, 104; D13/168;
D18/7; 455/566, 575.1, 575.3, 575.4
See application file for complete search history.

(56) **References Cited**

U.S. PATENT DOCUMENTS

D363,271 S * 10/1995 Peterson D14/341
D540,203 S * 4/2007 Jeon D10/65
D593,059 S * 5/2009 Kim et al. D14/138 G
D593,527 S * 6/2009 Wang et al. D14/138 G

D604,263 S * 11/2009 Kim D14/138 G
D605,157 S * 12/2009 Kim et al. D14/138 G
D619,989 S * 7/2010 Huang D14/138 G
D622,250 S * 8/2010 Kwon et al. D14/138 G
D636,769 S * 4/2011 Wood et al. D14/341
D639,763 S * 6/2011 Kim et al. D14/138 G
D641,018 S * 7/2011 Lee et al. D14/341
D645,435 S * 9/2011 Kim et al. D14/138 G
D645,833 S * 9/2011 Seflic et al. D14/138 G

(Continued)

OTHER PUBLICATIONS

HTC Jetstream, announced Sep. 2011, [online], [retrieved on Sep. 14, 2011]. Retrieved from Internet ,<URL: <http://www.gsmarena.com>>.*

(Continued)

Primary Examiner — Bridget L Eland
(74) *Attorney, Agent, or Firm* — NSIP Law

(57) **CLAIM**

The ornamental design for a mobile terminal, as shown and described.

DESCRIPTION

FIG. 1 is a front perspective view of a mobile terminal;
FIG. 2 is a front view of the mobile terminal of FIG. 1;
FIG. 3 is a rear view of the mobile terminal of FIG. 1;
FIG. 4 is a left-side view of the mobile terminal of FIG. 1;
FIG. 5 is a right-side view of the mobile terminal of FIG. 1;
FIG. 6 is a top plan view of the mobile terminal of FIG. 1;
FIG. 7 is a bottom plan view of the mobile terminal of FIG. 1;
FIG. 8 is a rear perspective view of the mobile terminal of FIG. 1; and,
FIG. 9 is an enlarged partial bottom perspective view of the mobile terminal of FIG. 1.

1 Claim, 7 Drawing Sheets

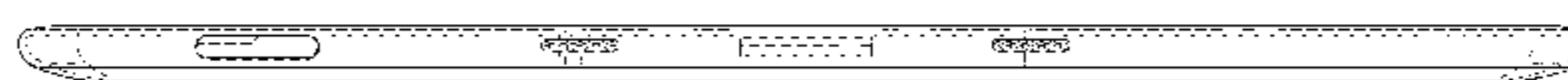
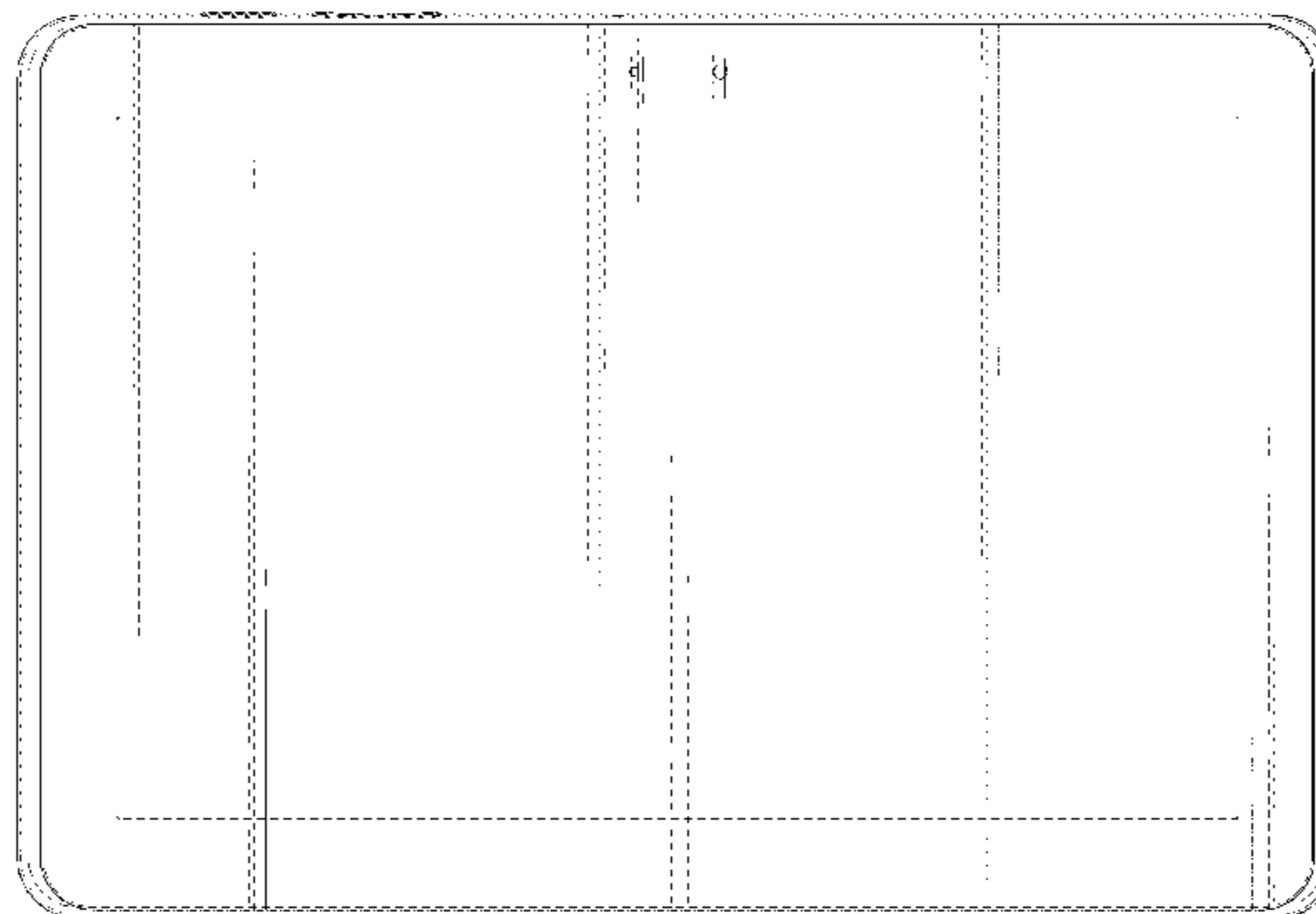

(56)

References Cited

U.S. PATENT DOCUMENTS

| | | | | | | |
|----------|---|---|---------|-------------|-------|-----------|
| D650,381 | S | * | 12/2011 | Park et al. | | D14/341 |
| D656,118 | S | * | 3/2012 | Kim et al. | | D14/138 G |
| D661,277 | S | * | 6/2012 | Kim | | D14/138 G |
| D663,298 | S | * | 7/2012 | Song et al. | | D14/341 |
| D664,954 | S | * | 8/2012 | Kim et al. | | D14/341 |
| D667,396 | S | * | 9/2012 | Koh | | D14/341 |
| D667,397 | S | * | 9/2012 | Koh | | D14/341 |
| D667,399 | S | * | 9/2012 | Koh | | D14/341 |
| D668,650 | S | * | 10/2012 | Han | | D14/341 |
| D669,469 | S | * | 10/2012 | Kang | | D14/341 |
| D671,514 | S | * | 11/2012 | Kim et al. | | D14/138 G |
| D672,345 | S | * | 12/2012 | Li | | D14/341 |
| D673,561 | S | * | 1/2013 | Hyun et al. | | D14/341 |

OTHER PUBLICATIONS

Samsung Galaxy Tab 8.9 3G, announced Mar. 2011, [online], [retrieved on Mar. 28, 2011]. Retrieved from Internet ,<URL: <http://www.gsmarena.com>>.*

Samsung Galaxy Tab 8.9 4G P7320T, announced 1st quarter 2012, [online], [retrieved on May 30, 2012]. Retrieved from Internet ,<URL: <http://www.gsmarena.com>>.*

Samsung Galaxy Note 10.1 N8010, announced Aug. 2012, [online], [retrieved on Aug. 22, 2012]. Retrieved from Internet ,<URL: <http://www.gsmarena.com>>.*

Samsung Galaxy Note 10.1 N8000, announced Aug. 2012, [online], [retrieved on Aug. 22, 2012]. Retrieved from Internet ,<URL: <http://www.gsmarena.com>>.*

Samsung Ativ Tab, announced Oct. 2012, [online], [retrieved on Nov. 28, 2012]. Retrieved from Internet ,<URL: <http://www.gsmarena.com>>.*

Huawei Ascend D quad, announced Feb. 2012, [online], [retrieved on Mar. 15, 2012]. Retrieved from Internet ,<URL: <http://www.gsmarena.com>>.*

Samsung Galaxy Tab 10.1 3G, announced Mar. 2011, [online], [retrieved on Mar. 28, 2011]. Retrieved from Internet ,<URL: <http://www.gsmarena.com>>.*

* cited by examiner

FIG. 1

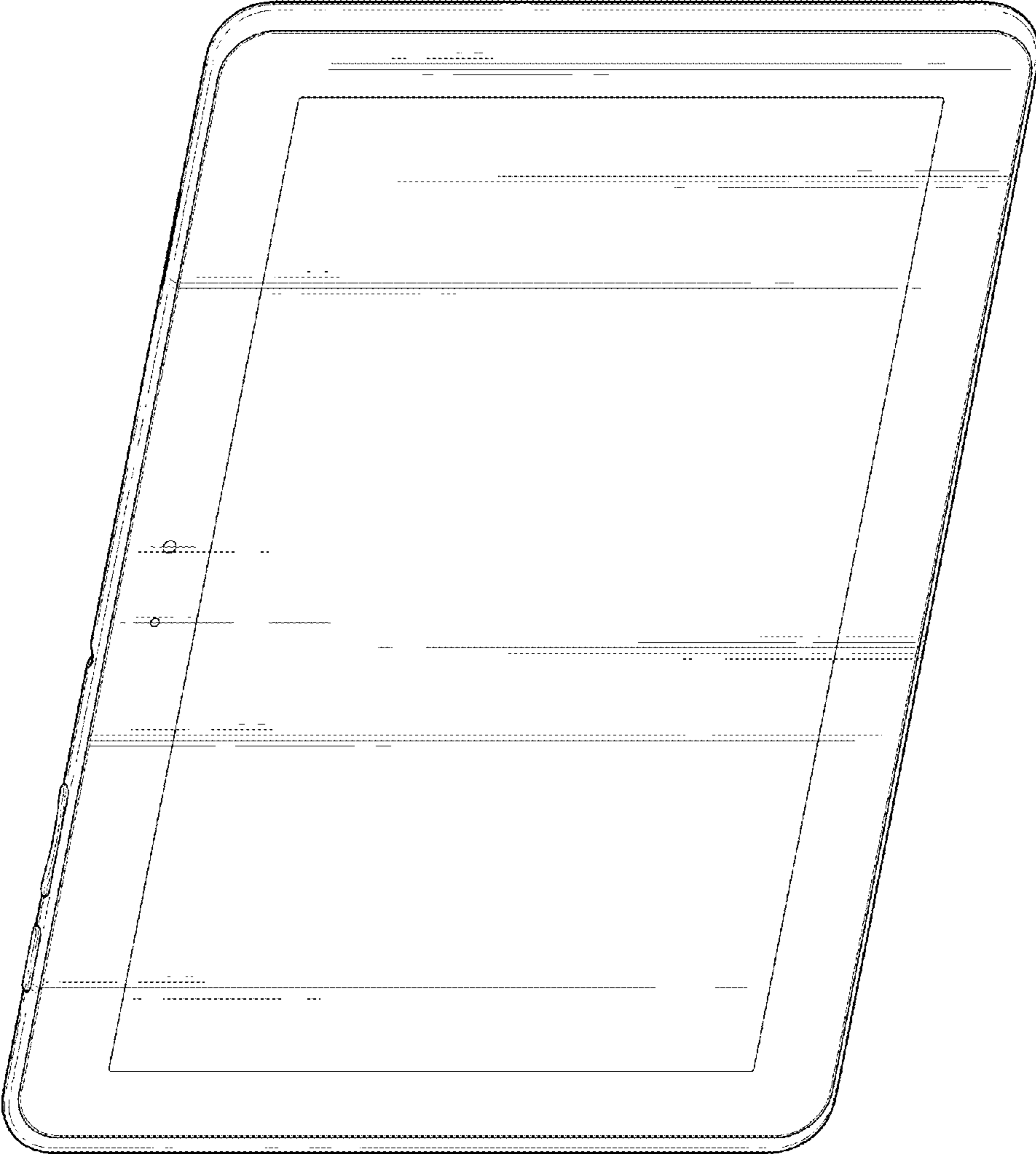

FIG. 2

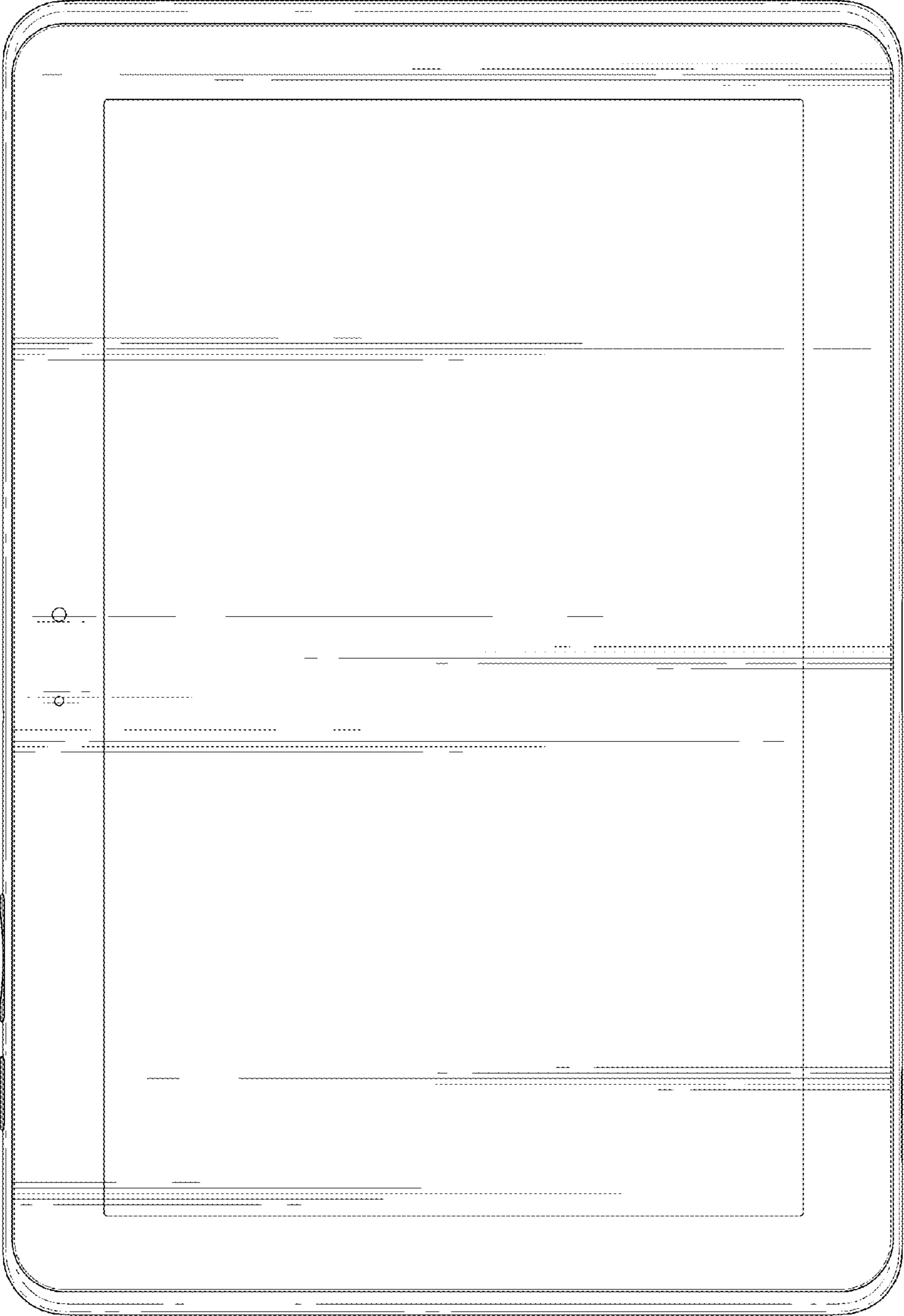
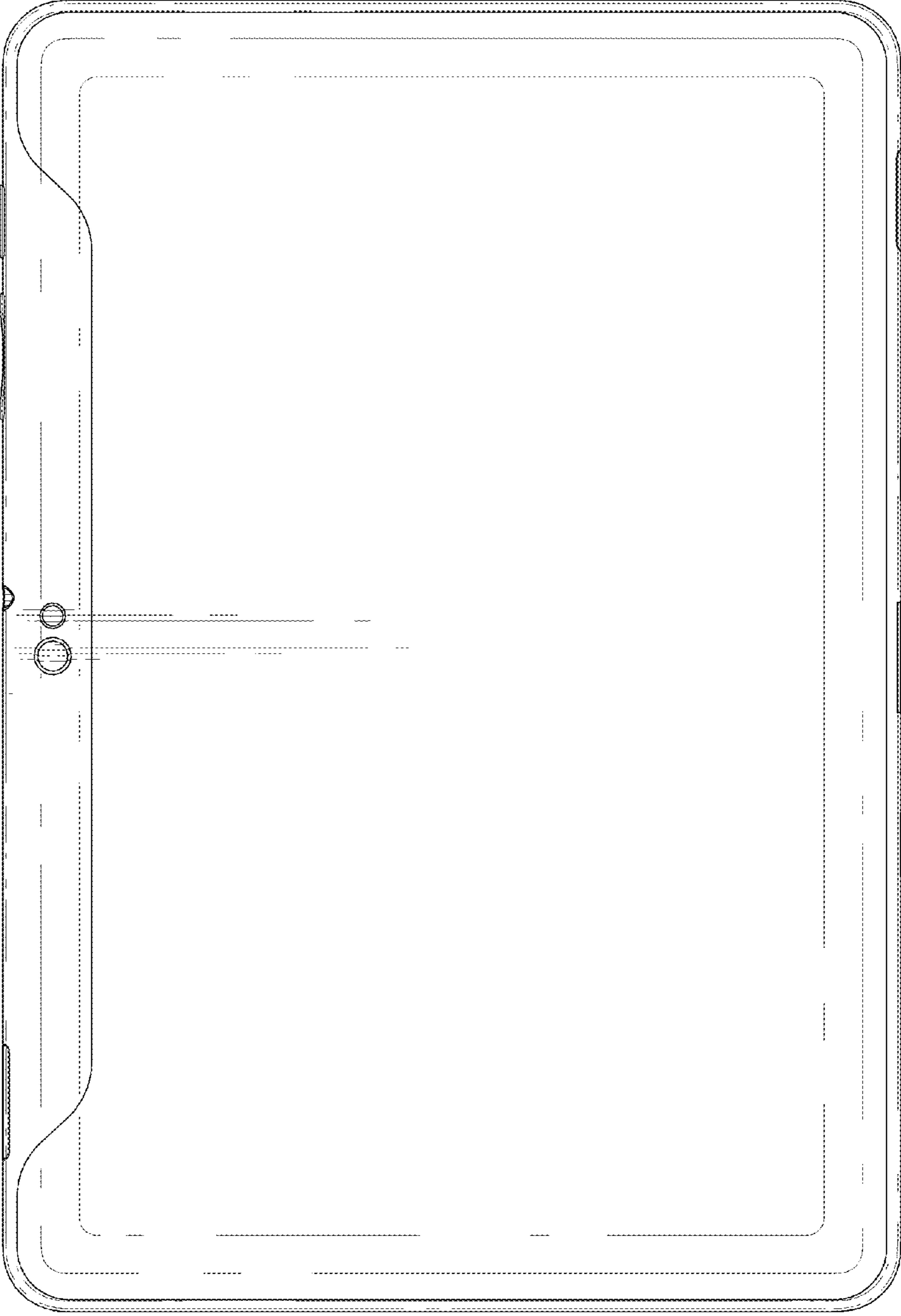

FIG. 3



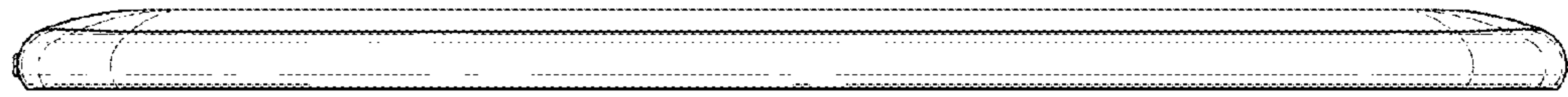

FIG. 5

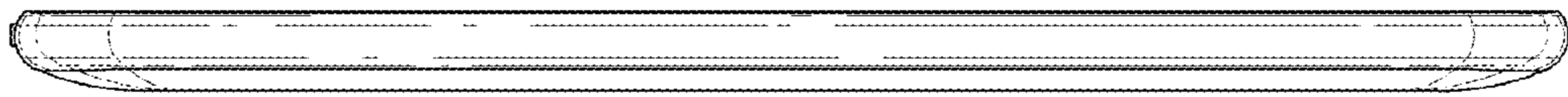

FIG. 4

FIG. 6



FIG. 7

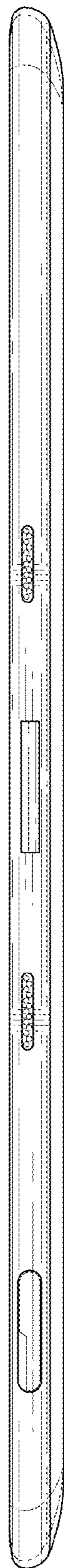

FIG. 8

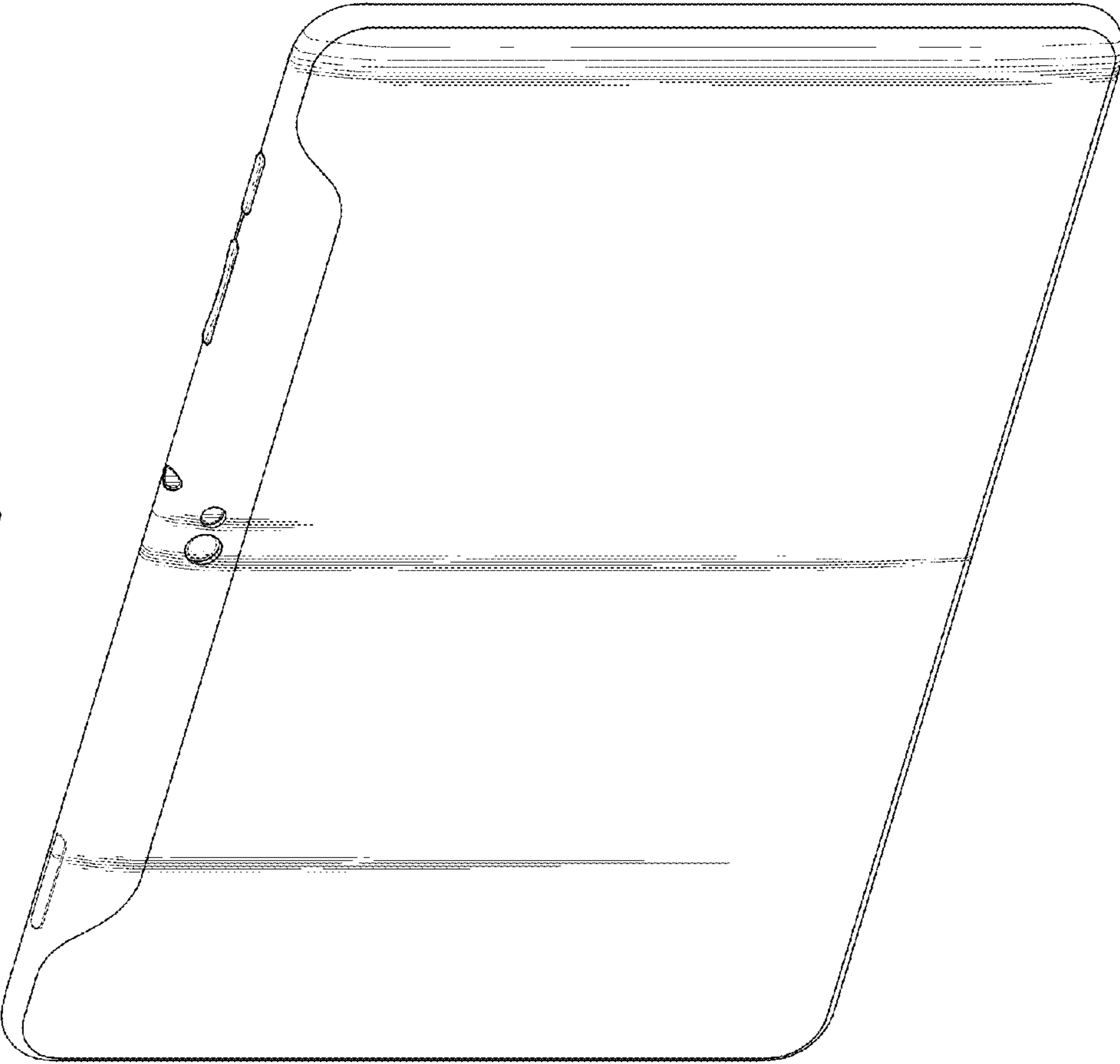

FIG. 9

