



US00D695223S

(12) **United States Design Patent**  
**Hyakutake et al.**

(10) **Patent No.:** **US D695,223 S**

(45) **Date of Patent:** **\*\* Dec. 10, 2013**

(54) **FERRULE FOR OPTICAL FIBER**  
(75) Inventors: **Yasuhiro Hyakutake**, Tokyo (JP);  
**Masahiro Abumi**, Tokyo (JP)  
(73) Assignee: **Adamant Kogyo Co., Ltd.**, Tokyo (JP)  
(\*\*) Term: **14 Years**  
(21) Appl. No.: **29/421,756**  
(22) Filed: **Sep. 14, 2012**

D480,689 S \* 10/2003 Ishibashi et al. .... D13/154  
D518,778 S \* 4/2006 Wardenburg ..... D13/134  
D651,971 S \* 1/2012 Esser et al. .... D13/133  
D665,745 S \* 8/2012 Yamauchi et al. .... D13/133  
D665,746 S \* 8/2012 Takita et al. .... D13/133  
D665,747 S \* 8/2012 Takita et al. .... D13/133  
D675,567 S \* 2/2013 Hyakutake ..... D13/133  
2003/0161586 A1 \* 8/2003 Hirabayashi ..... 385/78

\* cited by examiner

*Primary Examiner* — Thomas Johannes

(74) *Attorney, Agent, or Firm* — Manabu Kanesaka

(30) **Foreign Application Priority Data**  
Mar. 19, 2012 (JP) ..... 2012-006114  
(51) **LOC (9) Cl.** ..... **13-03**  
(52) **U.S. Cl.**  
USPC ..... **D13/133**  
(58) **Field of Classification Search**  
USPC ..... D13/133, 154, 184, 199; 385/53, 55,  
385/56, 72, 76, 78, 84; 439/180, 246, 252,  
439/374, 378, 379, 380, 381, 578, 668, 892,  
439/894  
See application file for complete search history.

(57) **CLAIM**  
The ornamental design for a ferrule for an optical fiber, as shown and described.

**DESCRIPTION**

FIG. 1 is a front view of a ferrule for an optical fiber showing our new design,  
FIG. 2 is a rear view thereof,  
FIG. 3 is a right side view thereof,  
FIG. 4 is a left side view thereof,  
FIG. 5 is a top plane view thereof,  
FIG. 6 is a bottom view thereof,  
FIG. 7 is a sectional view taken in the direction of line 7-7 in FIG. 4;  
FIG. 8 is a perspective view thereof; and,  
FIG. 9 is another perspective view thereof.

**1 Claim, 9 Drawing Sheets**

(56) **References Cited**  
U.S. PATENT DOCUMENTS  
5,781,674 A \* 7/1998 Asai ..... 385/78  
6,595,697 B2 \* 7/2003 Hirabayashi et al. .... 385/78

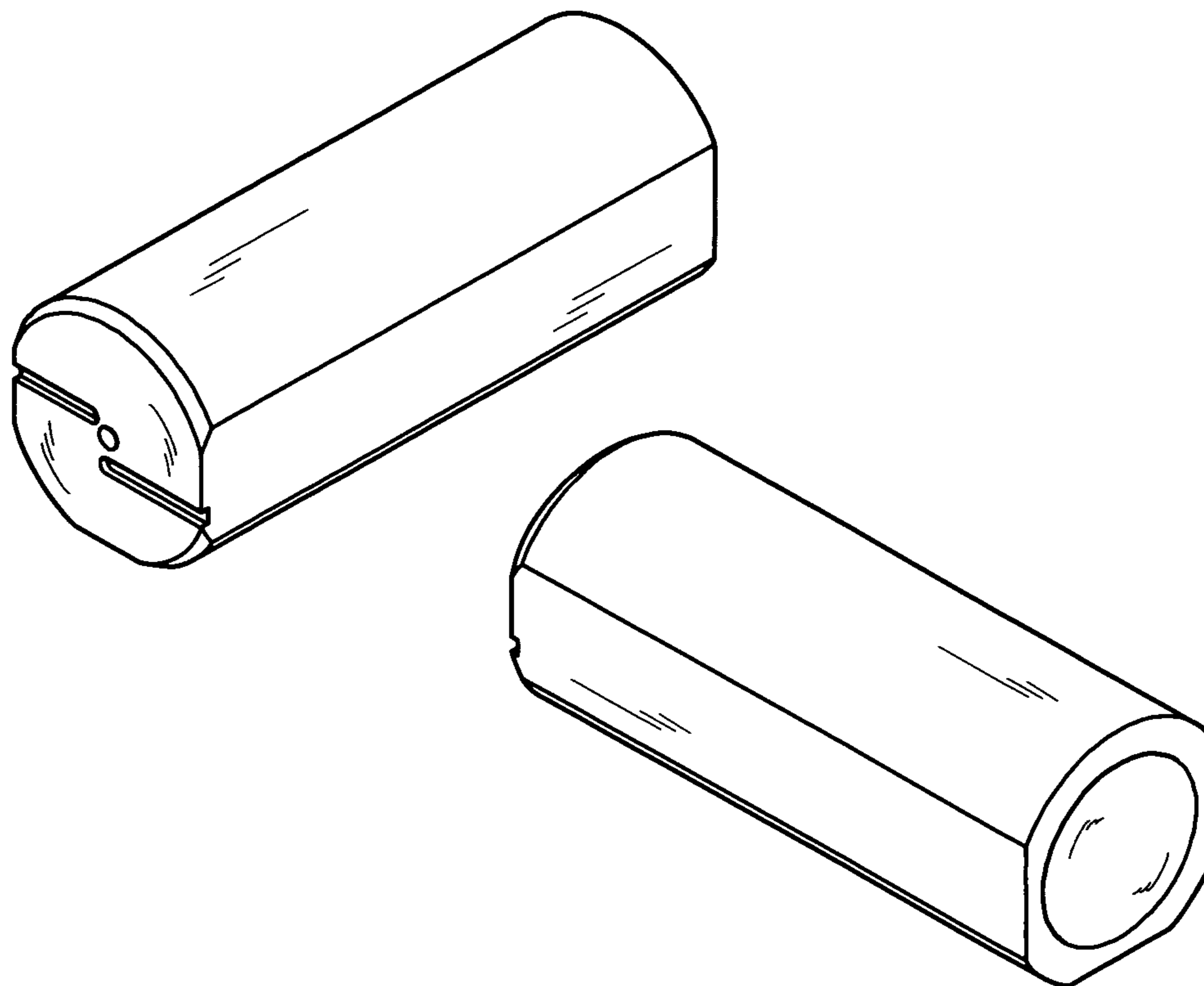

Fig. 1

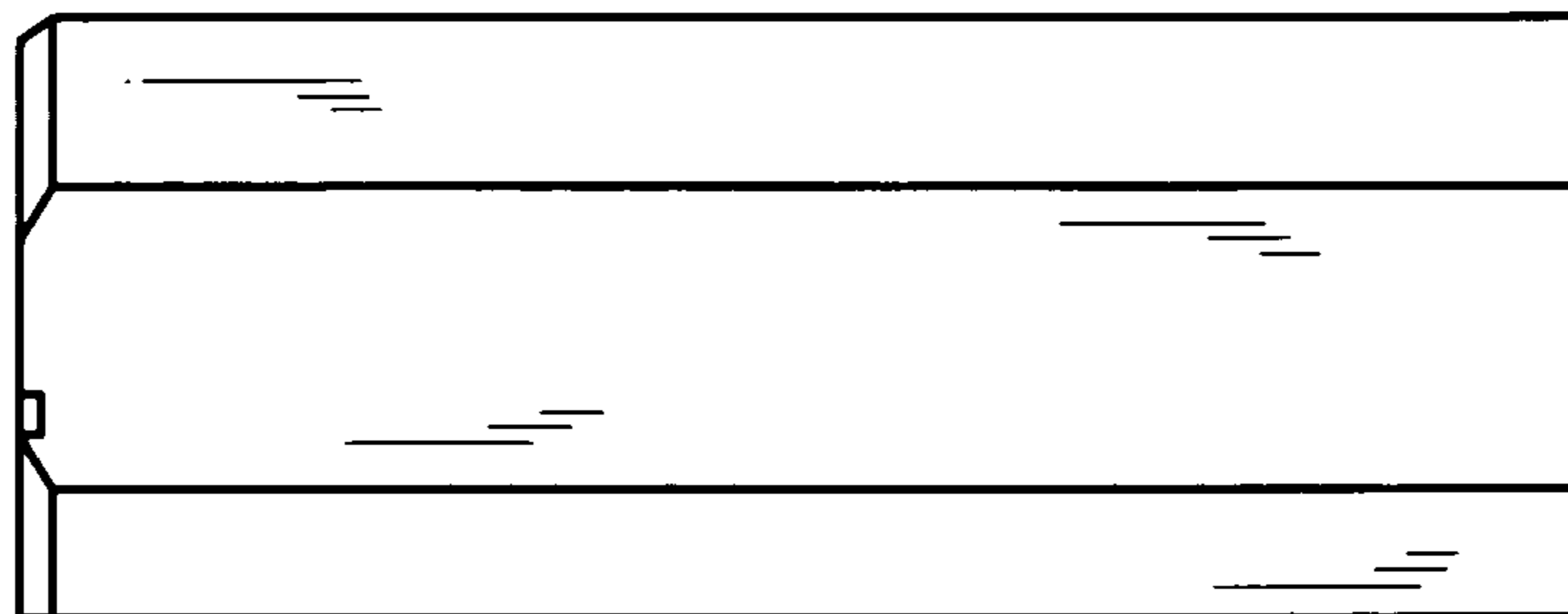

Fig. 2

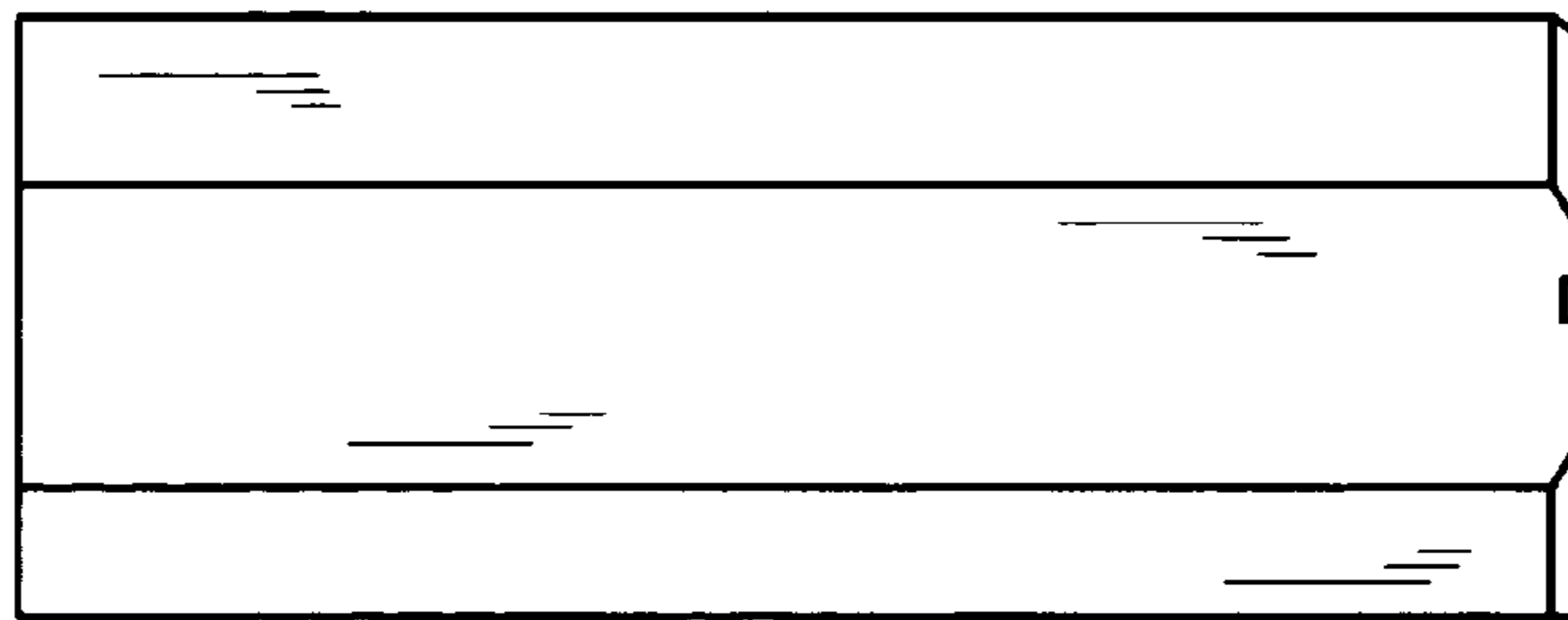

Fig. 3

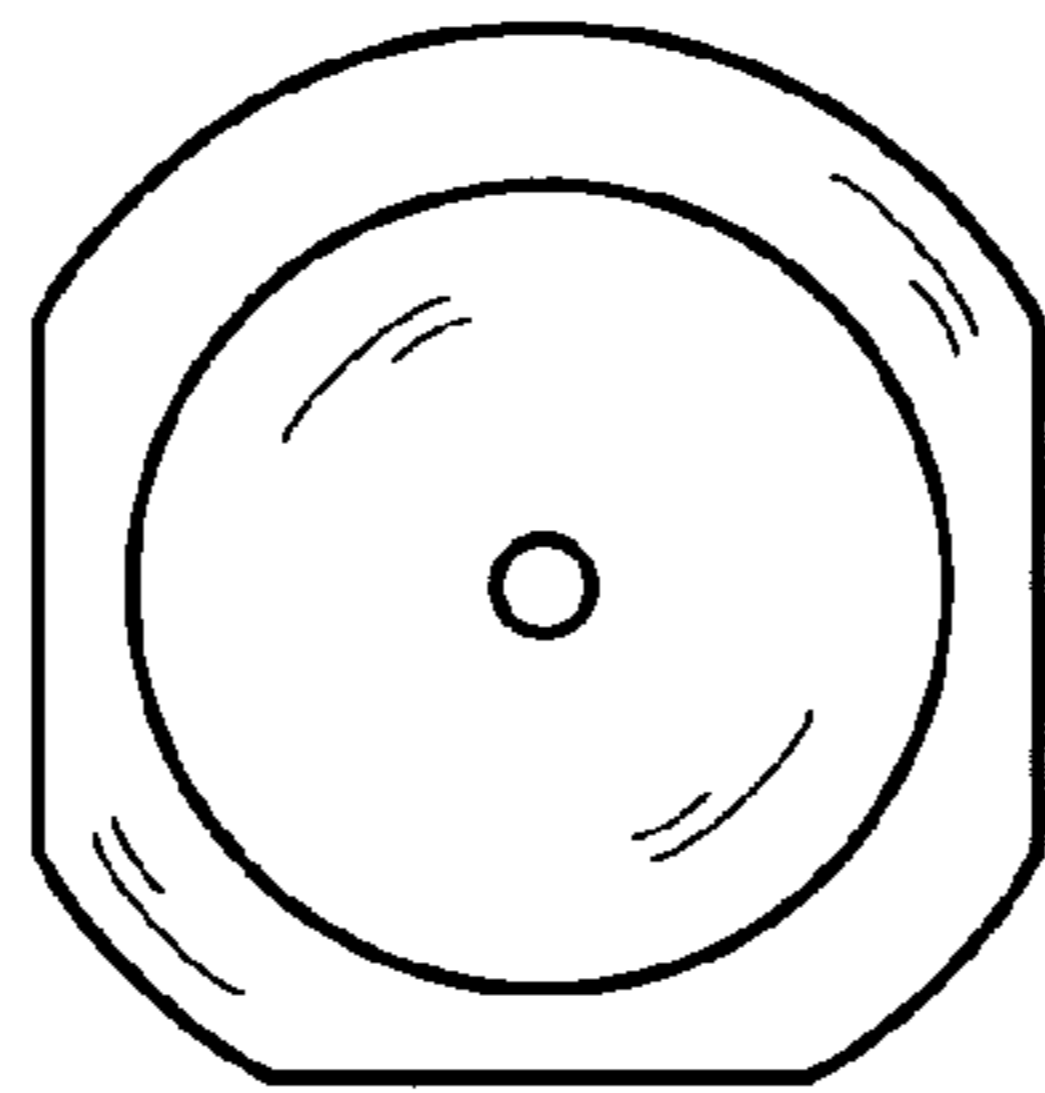

Fig. 4

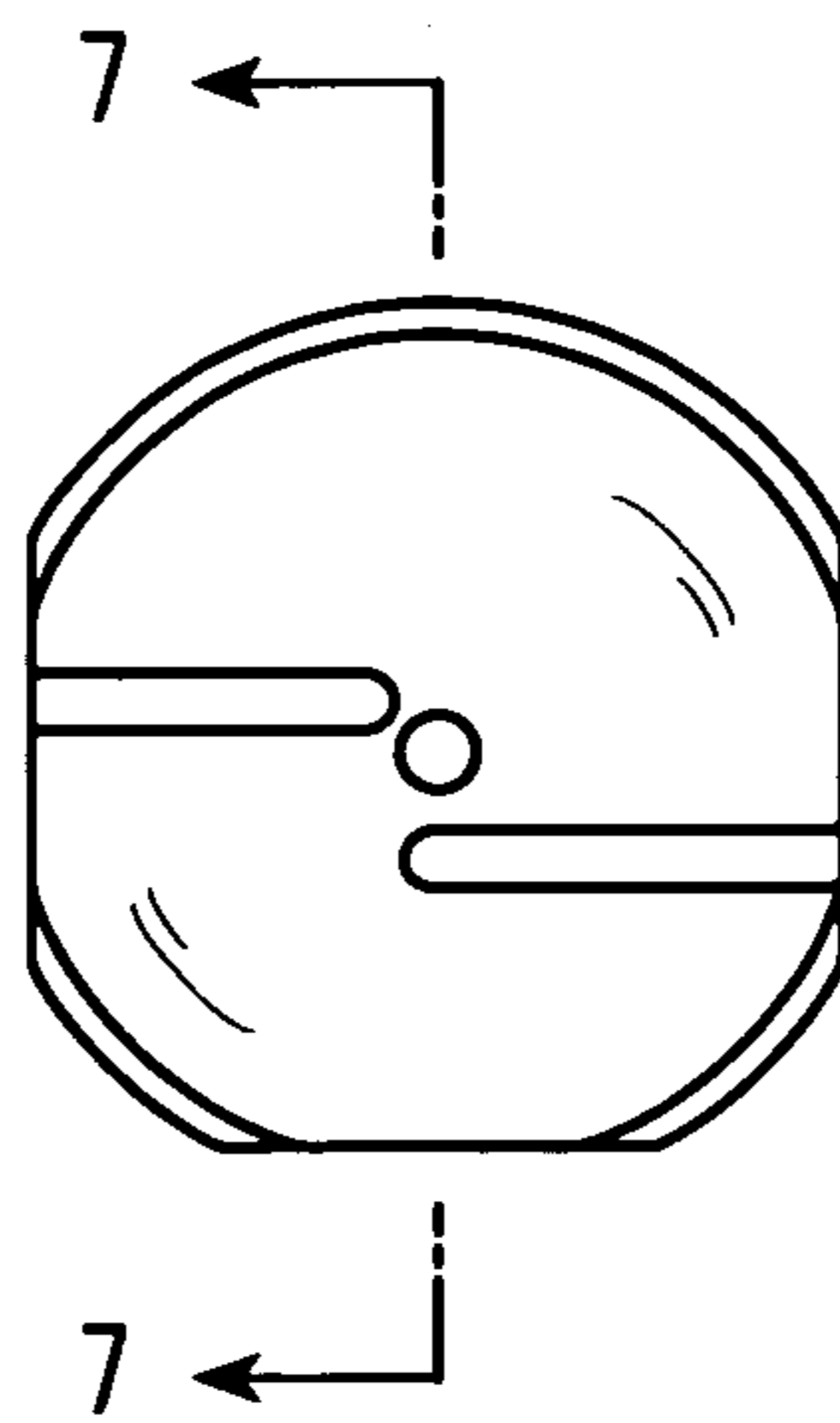

Fig. 5

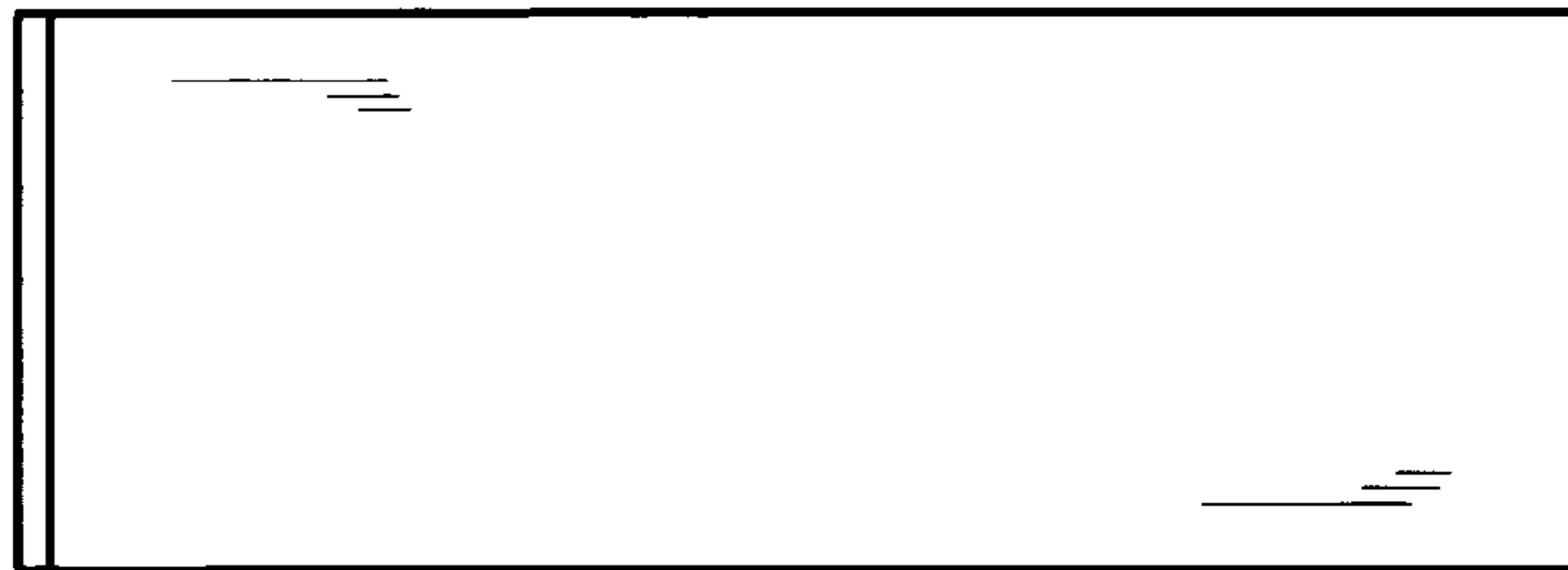

Fig. 6

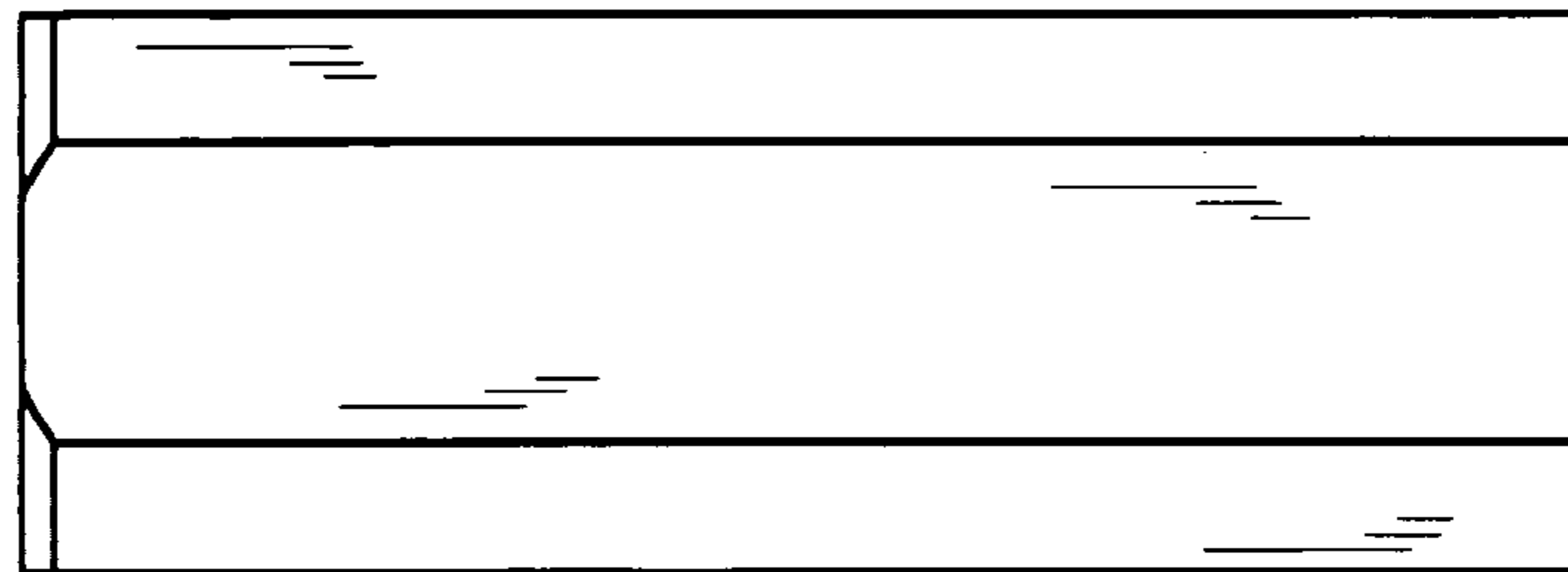

Fig. 7

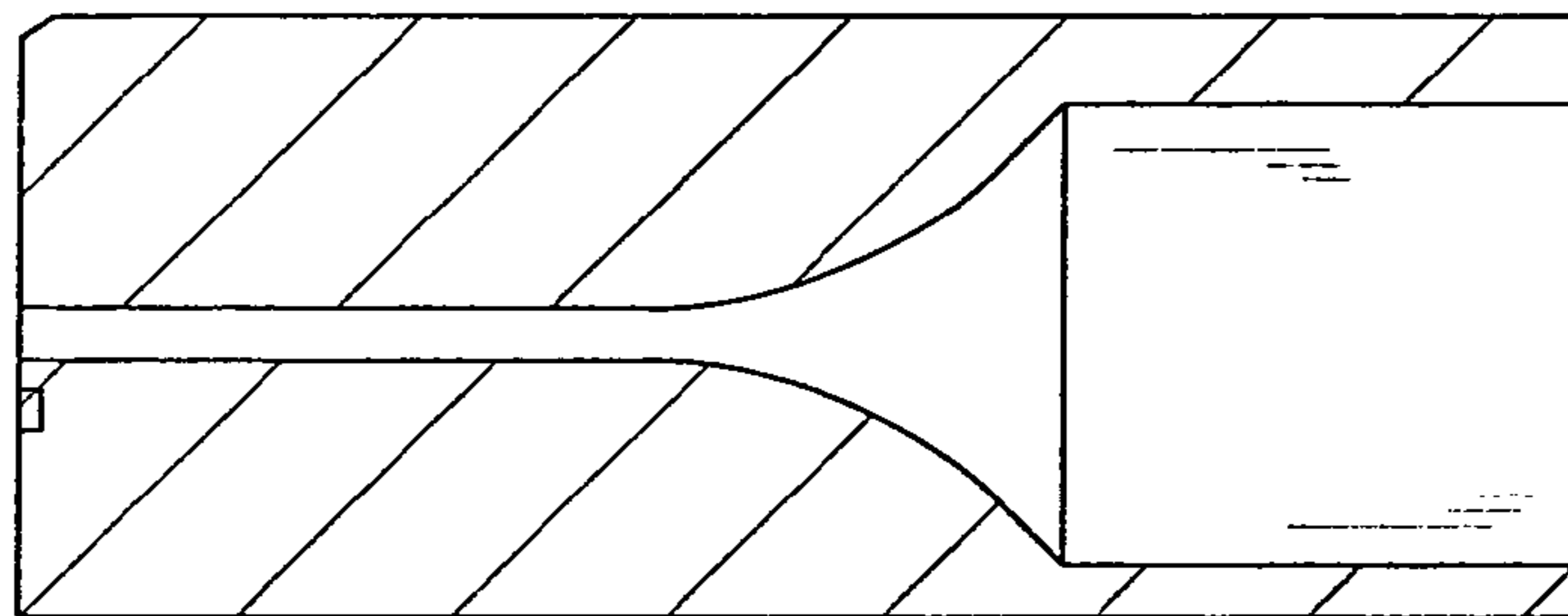



Fig. 8

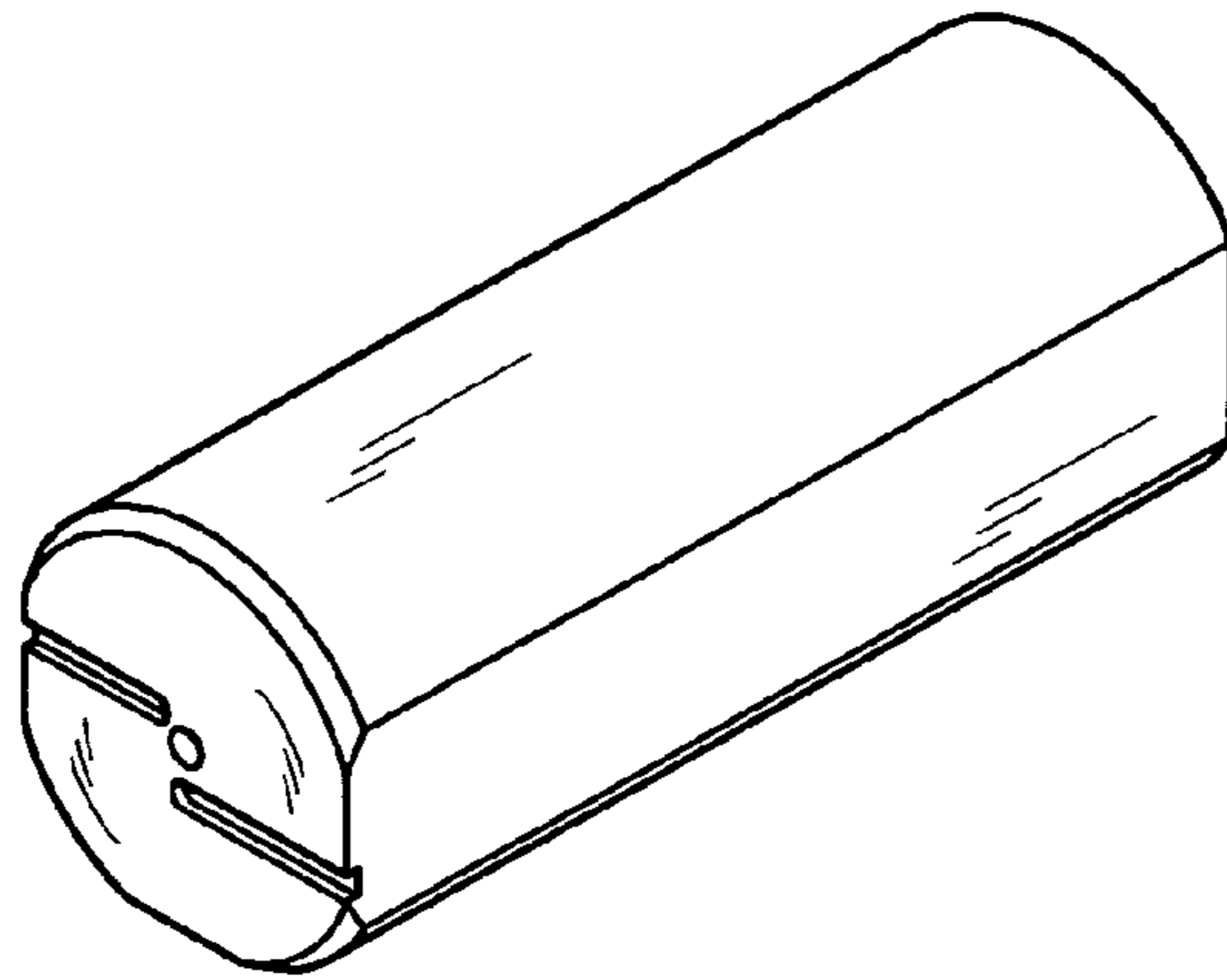

Fig. 9

